

YASKAWA AC Drive P1000

Industrial Fan and Pump Drive

Quick Start Guide

Type: CIMR-PU□A □□□□

Models: 200 V Class: 3/4 to 175 HP ND

400 V Class: 3/4 to 500 HP ND

600 V Class: 2 to 250 HP ND

To properly use the product, read this manual thoroughly and retain for easy reference, inspection, and maintenance. Ensure the end user receives this manual.

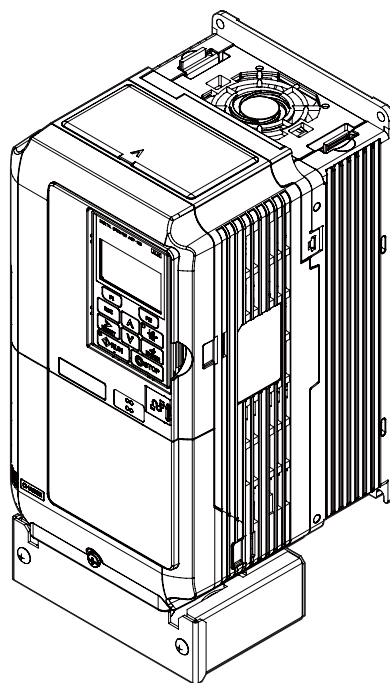

Receiving **1**

Mechanical Installation **2**

Electrical Installation **3**

Start-Up Programming & Operation **4**

Troubleshooting **5**

Periodic Inspection & Maintenance **6**

Peripheral Devices & Options **7**

Specifications **A**

Parameter List **B**

Standards Compliance **C**

Copyright © 2012 YASKAWA AMERICA, INC. All rights reserved.

No part of this publication may be reproduced, stored in a retrieval system, or transmitted, in any form or by any means, mechanical, electronic, photocopying, recording, or otherwise, without the prior written permission of Yaskawa. No patent liability is assumed with respect to the use of the information contained herein. Moreover, because Yaskawa is constantly striving to improve its high-quality products, the information contained in this manual is subject to change without notice. Every precaution has been taken in the preparation of this manual. Yaskawa assumes no responsibility for errors or omissions. Neither is any liability assumed for damages resulting from the use of the information contained in this publication.

◆ Quick Reference

Easily Set Parameters for Specific Applications

Preset parameter defaults are available for setting up applications. [Refer to Application Selection on page 84.](#)



Perform Auto-Tuning

Automatic tuning sets motor parameters. [Refer to Auto-Tuning on page 112.](#)

Maintenance Check Using Drive Monitors

Use drive monitors to check if fans, capacitors, or other components require maintenance. [Refer to Performance Life Monitors Maintenance Monitors on page 153.](#)

Fault Display and Troubleshooting

[Refer to Drive Alarms, Faults, and Errors on page 128.](#)

Standards Compliance

[Refer to European Standards on page 232](#) and [Refer to UL and CSA Standards on page 239](#) ^{<1>}.



<1> CE marking applies to 200 V class and 400 V class models only.

This Page Intentionally Blank

Table of Contents

QUICK REFERENCE	3
i. PREFACE & GENERAL SAFETY	11
i.1 Preface	12
Applicable Documentation.....	12
i.2 General Safety	13
Supplemental Safety Information	13
Safety Messages.....	14
General Application Precautions	16
Motor Application Precautions.....	17
Drive Label Warning Example.....	20
Warranty Information.....	20
1. RECEIVING	21
1.1 Model Number and Nameplate Check	22
Nameplate	22
2. MECHANICAL INSTALLATION.....	25
2.1 Mechanical Installation	26
Installation Environment.....	26
Installation Orientation and Spacing.....	26
3. ELECTRICAL INSTALLATION	37
3.1 Standard Connection Diagram.....	38
3.2 Main Circuit Connection Diagram.....	41
Three-Phase 200 V Class Models 2A0004 to 2A0081	
Three-Phase 400 V Class Models 4A0002 to 4A0044	
Three-Phase 600 V Class Models 5A0003 to 5A0032	41
Three-Phase 200 V Class Models 2A0110, 2A0138	
Three-Phase 400 V Class Models 4A0058, 4A0072	
Three-Phase 600 V Class Models 5A0041, 5A0052	41
Three-Phase 200 V Class Models 2A0169 to 2A0211	
Three-Phase 400 V Class Models 4A0088 to 4A0139	
Three-Phase 600 V Class Models 5A0062 to 5A0099	42
Three-Phase 200 V Class Models 2A0250 to 2A0415	
Three-Phase 400 V Class Models 4A0165 to 4A0675	
Three-Phase 600 V Class Models 5A0125 to 5A0242	42
3.3 Terminal Cover	43

Table of Contents

Models 2A0004 to 2A0081, 4A0002 to 4A0044, 5A0003 to 5A0032 (IP20/NEMA Type 1 Enclosure).....	43
Models 2A0110 to 2A0250, 4A0208 to 4A0675, and 5A0125 to 5A0242 (IP00/Open Type Enclosure).....	44
3.4 Digital Operator and Front Cover.....	45
Removing/Reattaching the Digital Operator.....	45
Removing/Reattaching the Front Cover.....	45
3.5 Top Protective Cover.....	48
Removing the Top Protective Cover.....	48
Reattaching the Top Protective Cover.....	48
3.6 Main Circuit Wiring.....	49
Main Circuit Terminal Functions.....	49
Protecting Main Circuit Terminals.....	50
Wire Gauges and Tightening Torque.....	51
Main Circuit Terminal and Motor Wiring.....	57
3.7 Control Circuit Wiring.....	60
Control Circuit Terminal Block Functions.....	60
Terminal Configuration.....	62
Wiring the Control Circuit Terminal.....	63
3.8 Control I/O Connections.....	65
Sinking/Sourcing Mode Switch for Digital Inputs.....	65
Using the Pulse Train Output.....	66
Terminals A1, A2, and A3 Input Signal Selection.....	67
Terminal AM/FM Signal Selection.....	68
3.9 Connect to a PC.....	69
3.10 Wiring Checklist.....	70
4. START-UP PROGRAMMING & OPERATION.....	71
4.1 Using the Digital Operator.....	72
Keys and Displays.....	72
LCD Display.....	73
ALARM (ALM) LED Displays.....	74
LO/RE LED and RUN LED Indications.....	74
Menu Structure for Digital Operator.....	75
4.2 The Drive, Programming, and Clock Adjustment Modes.....	76
Real-Time Clock (RTC).....	76
Clock Adjustment.....	76
Changing Parameter Settings or Values.....	79
Switching Between LOCAL and REMOTE.....	80
4.3 Start-Up Flowchart.....	82
4.4 Powering Up the Drive.....	83
Powering Up the Drive and Operation Status Display.....	83
4.5 Application Selection.....	84
4.6 Basic Drive Setup Adjustments.....	85
EZ Sleep/Wake-up Function.....	90
4.7 Auto-Tuning.....	112
Types of Auto-Tuning.....	112
Auto-Tuning Interruption and Fault Codes.....	112

Auto-Tuning Operation Example	113
4.8 No-Load Operation Test Run.....	115
No-Load Operation Test Run	115
4.9 Test Run with Load Connected.....	117
Test Run with the Load Connected	117
4.10 Test Run Checklist	118
4.11 Fan and Pump Application Presets	119
A1-03 = 8008: Pump	119
A1-03 = 8009: Pump w/ PI	119
A1-03 = 8010: Fan	120
A1-03 = 8011: Fan w/ PI	120
Default Values for Fan and Pump Applications	121
4.12 Fan and Pump Application Preset Details	122
5. TROUBLESHOOTING.....	127
5.1 Drive Alarms, Faults, and Errors	128
Types of Alarms, Faults, and Errors	128
5.2 Fault Detection	129
Fault Displays, Causes, and Possible Solutions	129
5.3 Alarm Detection	139
Alarm Codes, Causes, and Possible Solutions	139
5.4 Operator Programming Errors	142
Operator Programming Error Codes, Causes, and Possible Solutions.....	142
5.5 Auto-Tuning Fault Detection	143
Auto-Tuning Codes, Causes, and Possible Solutions.....	143
5.6 Copy Function Related Displays	146
Tasks, Errors, and Troubleshooting	146
Fault Reset Methods	146
6. PERIODIC INSPECTION & MAINTENANCE	149
6.1 Inspection	150
Recommended Daily Inspection.....	150
Recommended Periodic Inspection.....	151
6.2 Periodic Maintenance	153
Replacement Parts.....	153
6.3 Drive Replacement	155
Replacing the Drive	155
7. PERIPHERAL DEVICES & OPTIONS	157
7.1 Option Card Installation.....	158
Prior to Installing the Option	158
Communication Option Installation Example.....	159
A. SPECIFICATIONS	163
A.1 Power Ratings	164
Three-Phase 200 V Class Drive Models 2A0004 to 2A0030	164
Three-Phase 200 V Class Drive Models 2A0040 to 2A0211	165

Table of Contents

Three-Phase 200 V Class Drive Models 2A0250 to 2A0415	166
Three-Phase 400 V Class Drive Models 4A0002 to 4A0031	167
Three-Phase 400 V Class Drive Models 4A0038 to 4A0165	168
Three-Phase 400 V Class Drive Models 4A0208 to 4A0675	169
Three-Phase 600 V Class Drive Models 5A0003 to 5A0032	170
Three-Phase 600 V Class Drive Models 5A0041 to 5A0099	171
Three-Phase 600 V Class Drive Models 5A0125 to 5A0242	172
A.2 Drive Specifications	173
A.3 Drive Watt Loss Data	175
B. PARAMETER LIST	177
B.1 A: Initialization Parameters	178
A1: Initialization	178
A2: User Parameters	178
B.2 b: Application	179
b1: Operation Mode Selection	179
b2: DC Injection Braking and Short Circuit Braking	179
b3: Speed Search	180
b4: Timer Function	181
b5: PID Control	181
b6: Dwell Function	184
b8: Energy Saving	184
B.3 C: Tuning	185
C1: Acceleration and Deceleration Times	185
C2: S-Curve Characteristics	185
C3: Slip Compensation	186
C4: Torque Compensation	186
C6: Carrier Frequency	186
B.4 d: References	187
d1: Frequency Reference	187
d2: Frequency Upper/Lower Limits	188
d3: Jump Frequency	188
d4: Frequency Reference Hold and Up/Down 2 Function	188
d6: Field Weakening and Field Forcing	189
B.5 E: Motor Parameters	190
E1: V/f Pattern	190
E2: Motor 1 Parameters	191
F4: Analog Monitor Card (AO-A3)	191
F6, F7: Communication Option Card	192
B.6 H Parameters: Multi-Function Terminals	196
H1: Multi-Function Digital Inputs	196
H2: Multi-Function Digital Outputs	199
H3: Multi-Function Analog Inputs	201
H4: Analog Outputs	202
H5: MEMOBUS/Modbus Serial Communication	203
H6: Pulse Train Input	204
B.7 L: Protection Function	205
L1: Motor Protection	205
L2: Momentary Power Loss Ride-Thru	205
L3: Stall Prevention	206

L4: Speed Detection	207
L5: Fault Restart	208
L6: Torque Detection	208
L8: Drive Protection	210
B.8 n: Special Adjustment	212
n1: Hunting Prevention	212
n3: High Slip Braking (HSB) and Overexcitation Braking	212
B.9 o: Operator-Related Settings	213
o1: Digital Operator Display Selection	213
o2: Digital Operator Keypad Functions	214
o3: Copy Function	214
o4: Maintenance Monitor Settings	215
B.10 S: Special Application	216
S1: Dynamic Noise Control Function	216
S2: Programmable Run Timers	216
S3: Secondary PI (PI2) Control	219
S6: P1000 Protection	220
B.11 T: Motor Tuning	221
T1: Induction Motor Auto-Tuning	221
B.12 U: Monitors	222
U1: Operation Status Monitors	222
U2: Fault Trace	224
U3: Fault History	225
U4: Maintenance Monitors	226
U5: PID Monitors	228
U6: Operation Status Monitors	229
C. STANDARDS COMPLIANCE	231
C.1 European Standards	232
CE Low Voltage Directive Compliance	232
EMC Guidelines Compliance	234
C.2 UL and CSA Standards	239
UL Standards Compliance	239
CSA Standards Compliance	245
Drive Motor Overload Protection	245
Precautionary Notes on External Heatsink (IP00/Open Type Enclosure)	247

This Page Intentionally Blank

Preface & General Safety

This section provides safety messages pertinent to this product that, if not heeded, may result in fatality, personal injury, or equipment damage. Yaskawa is not responsible for the consequences of ignoring these instructions.

i.1	PREFACE.....	12
i.2	GENERAL SAFETY.....	13

i.1 Preface

Yaskawa manufactures products used as components in a wide variety of industrial systems and equipment. The selection and application of Yaskawa products remain the responsibility of the equipment manufacturer or end user. Yaskawa accepts no responsibility for the way its products are incorporated into the final system design. Under no circumstances should any Yaskawa product be incorporated into any product or design as the exclusive or sole safety control. Without exception, all controls should be designed to detect faults dynamically and fail safely under all circumstances. All systems or equipment designed to incorporate a product manufactured by Yaskawa must be supplied to the end user with appropriate warnings and instructions as to the safe use and operation of that part. Any warnings provided by Yaskawa must be promptly provided to the end user. Yaskawa offers an express warranty only as to the quality of its products in conforming to standards and specifications published in the Yaskawa manual. **NO OTHER WARRANTY, EXPRESS OR IMPLIED, IS OFFERED.** Yaskawa assumes no liability for any personal injury, property damage, losses, or claims arising from misapplication of its products.

This manual is designed to ensure correct and suitable application of drives. Read this manual before attempting to install, operate, maintain, or inspect a drive and keep it in a safe, convenient location for future reference. Be sure you understand all precautions and safety information before attempting application.

◆ Applicable Documentation

The following manuals are available for P1000 series drives:

	P1000 Series AC Drive Quick Start Guide (TOEPYAIP1U01)
	Read this guide first. This guide is packaged together with the product and contains basic information required to install and wire the drive. It also gives an overview of fault diagnostics, maintenance, and parameter settings. The purpose of this guide is to prepare the drive for a trial run with an application and for basic operation. This manual is available for download on our documentation website, www.yaskawa.com .
	P1000 Series AC Drive Technical Manual (SIEPYAIP1U01)
	This manual provides detailed information on parameter settings, drive functions, and MEMOBUS/Modbus specifications. Use this manual to expand drive functionality and to take advantage of higher performance features. This manual is available for download on our documentation website, www.yaskawa.com .

i.2 General Safety

◆ Supplemental Safety Information

General Precautions

- The diagrams in this manual may be indicated without covers or safety shields to show details. Replace the covers or shields before operating the drive and run the drive according to the instructions described in this manual.
- Any illustrations, photographs, or examples used in this manual are provided as examples only and may not apply to all products to which this manual is applicable.
- The products and specifications described in this manual or the content and presentation of the manual may be changed without notice to improve the product and/or the manual.
- When ordering a new copy of the manual due to damage or loss, contact your Yaskawa representative or the nearest Yaskawa sales office and provide the manual number shown on the front cover.
- If nameplate becomes worn or damaged, order a replacement from your Yaskawa representative or the nearest Yaskawa sales office.

WARNING

Read and understand this manual before installing, operating or servicing this drive. The drive must be installed according to this manual and local codes.

The following conventions are used to indicate safety messages in this manual. Failure to heed these messages could result in serious or fatal injury or damage to the products or to related equipment and systems.

DANGER

Indicates a hazardous situation, which, if not avoided, will result in death or serious injury.

WARNING

Indicates a hazardous situation, which, if not avoided, could result in death or serious injury.

WARNING! *may also be indicated by a bold key word embedded in the text followed by an italicized safety message.*

CAUTION

Indicates a hazardous situation, which, if not avoided, could result in minor or moderate injury.

CAUTION! *may also be indicated by a bold key word embedded in the text followed by an italicized safety message.*

NOTICE

Indicates a property damage message.

NOTICE: *may also be indicated by a bold key word embedded in the text followed by an italicized safety message.*

◆ Safety Messages

DANGER

Heed the safety messages in this manual.

Failure to comply will result in death or serious injury.

The operating company is responsible for any injuries or equipment damage resulting from failure to heed the warnings in this manual.

Electrical Shock Hazard

Do not connect or disconnect wiring while the power is on.

Failure to comply will result in death or serious injury.

Before servicing, disconnect all power to the equipment. The internal capacitor remains charged even after the power supply is turned off. After shutting off the power, wait for at least the amount of time specified on the drive before touching any components.

WARNING

Sudden Movement Hazard

System may start unexpectedly upon application of power, resulting in death or serious injury.

Clear all personnel from the drive, motor and machine area before applying power. Secure covers, couplings, shaft keys and machine loads before applying power to the drive.

Electrical Shock Hazard

Do not attempt to modify or alter the drive in any way not explained in this manual.

Failure to comply could result in death or serious injury.

Yaskawa is not responsible for any modification of the product made by the user. This product must not be modified.

Do not allow unqualified personnel to use equipment.

Failure to comply could result in death or serious injury.

Maintenance, inspection, and replacement of parts must be performed only by authorized personnel familiar with installation, adjustment and maintenance of AC drives.

Do not remove covers or touch circuit boards while the power is on.

Failure to comply could result in death or serious injury.

Make sure the protective earthing conductor complies with technical standards and local safety regulations.

Because the leakage current exceeds 3.5 mA in models 4A0414 and larger, IEC 61800-5-1 states that either the power supply must be automatically disconnected in case of discontinuity of the protective earthing conductor or a protective earthing conductor with a cross-section of at least 10 mm² (Cu) or 16 mm² (Al) must be used. Failure to comply may result in death or serious injury.

Always use appropriate equipment for Ground Fault Circuit Interrupters (GFCIs).

The drive can cause a residual current with a DC component in the protective earthing conductor. Where a residual current operated protective or monitoring device is used for protection in case of direct or indirect contact, always use a type B GFCI according to IEC 60755.

Fire Hazard

Do not use an improper voltage source.

Failure to comply could result in death or serious injury by fire.

Verify that the rated voltage of the drive matches the voltage of the incoming power supply before applying power.

⚠ WARNING

Install adequate branch circuit protection according to applicable local codes and this Installation Manual. Failure to comply could result in fire and damage to the drive or injury to personnel.

The device is suitable for use on a circuit capable of delivering not more than 100,000 RMS symmetrical amperes, 240 Vac maximum (200 V class) and 480 Vac maximum (400 V class), and 600 Vac maximum (600 V class) when protected by branch circuit protection devices specified in this supplement.

Crush Hazard

Do not use this drive in lifting applications without installing external safety circuitry to prevent accidental dropping of the load.

The drive does not possess built-in load drop protection for lifting applications.

Failure to comply could result in death or serious injury from falling loads.

Install electrical and/or mechanical safety circuit mechanisms independent of drive circuitry.

⚠ CAUTION**Crush Hazard**

Do not carry the drive by the front cover.

Failure to comply may result in minor or moderate injury from the main body of the drive falling.

NOTICE

Observe proper electrostatic discharge procedures (ESD) when handling the drive and circuit boards.

Failure to comply may result in ESD damage to the drive circuitry.

Do not perform a withstand voltage test on any part of the drive.

Failure to comply could result in damage to the sensitive devices within the drive.

Do not operate damaged equipment.

Failure to comply could result in further damage to the equipment.

Do not connect or operate any equipment with visible damage or missing parts.

If a fuse is blown or a Ground Fault Circuit Interrupter (GFCI) is tripped, check the wiring and the selection of the peripheral devices.

Contact your supplier if the cause cannot be identified after checking the above.

Do not restart the drive immediately operate the peripheral devices if a fuse is blown or a GFCI is tripped.

Check the wiring and the selection of peripheral devices to identify the cause. Contact your supplier before restarting the drive or the peripheral devices if the cause cannot be identified.

Install adequate branch circuit short circuit protection per applicable codes.

Failure to comply could result in damage to the drive.

The drive is suitable for use on a circuit capable of delivering not more than 100,000 RMS symmetrical Amperes, 240 Vac maximum (200 V Class), 480 Vac maximum (400 V Class), and 600 Vac maximum (600 V Class) when protected by Bussmann Type FWH or FWP fuses as specified in *Factory Recommended Branch Circuit Protection* on page 232.

Do not expose the drive to halogen group disinfectants.

Failure to comply may cause damage to the electrical components in the drive.

Do not pack the drive in wooden materials that have been fumigated or sterilized.

Do not sterilize the entire package after the product is packed.

◆ General Application Precautions

■ Selection

Installing a Reactor

Use an AC reactor or DC link choke in the following situations:

- to suppress harmonic current.
- to smooth peak current that results from capacitor switching.
- when the power supply is above 600 kVA.
- when the drive is running from a power supply system with thyristor converters.

Note: A DC link choke is built in to drive models 2A0110 to 2A0415 and 4A0058 to 4A0675.

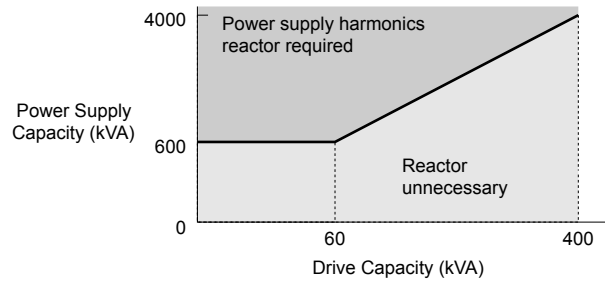

Figure i.1 Installing a Reactor

Drive Capacity

For specialized motors, make sure that the motor rated current is less than the rated output current for the drive.

When running more than one motor in parallel from a single drive, the capacity of the drive should be larger than [total motor rated current \times 1.1].

Starting Torque

The overload rating for the drive determines the starting and accelerating characteristics of the motor. Expect lower torque than when running from line power. To get more starting torque, use a larger drive or increase both the motor and drive capacity.

Emergency Stop

During a drive fault condition, the output shuts off but the motor does not stop immediately. A mechanical brake may be required when it is necessary to stop the motor faster than the ability of the Fast Stop function of the drive.

Options

NOTICE: The B1, B2, -, +1, +2, and +3 terminals are used to connect optional drive-specific compatible devices only. Connecting non-Yaskawa-approved devices to these terminals may damage the drive.

Repetitive Starting/Stopping

Laundry machines, punching presses, and other applications with frequent starts and stops often approach 150% of their rated current values. Heat stress generated from repetitive high current will shorten the life span of the IGBTs.

Yaskawa recommends lowering the carrier frequency, particularly when audible noise is not a concern. It is beneficial to reduce the load, increase the acceleration and deceleration times, or switch to a larger drive to help keep peak current levels under 150%. Be sure to check the peak current levels when starting and stopping repeatedly during the initial test run, and make adjustments accordingly.

■ Installation

Enclosure Panels

Keep the drive in a clean environment by installing the drive in an enclosure panel or selecting an installation area free of airborne dust, lint, and oil mist. Be sure to leave the required space between drives to provide for cooling, and take proper measures so the ambient temperature remains within allowable limits and keep flammable materials away from the drive. Yaskawa offers protective designs for drives that must be used in areas subjected to oil mist and excessive vibration. Contact Yaskawa or your Yaskawa agent for details.

Installation Direction

NOTICE: Install the drive upright as specified in the manual. [Refer to Mechanical Installation on page 26](#) for more information on installation. Failure to comply may damage the drive due to improper cooling.

■ Settings

Upper Limits

NOTICE: The drive is capable of running the motor up to 400 Hz. Be sure to set the upper limit for the frequency of the drive to prevent the possible danger of accidentally operating equipment at higher than rated speed. The default setting for the maximum output frequency is 60 Hz.

DC Injection Braking

NOTICE: Excessive current during DC Injection Braking and excessive duration of DC Injection Braking can cause motor overheating.

Acceleration/Deceleration Times

Acceleration and deceleration times are affected by the amount of torque generated by the motor, the load torque, and the inertia moment. Set a longer accel/decel time when Stall Prevention is enabled. The accel/decel times are lengthened for as long as the Stall Prevention function is in operation. Install one of the available braking options or increase the capacity of the drive for faster acceleration and deceleration.

■ General Handling

Wiring Check

NOTICE: Do not connect power supply lines to output terminals U/T1, V/T2, or W/T3. Failure to comply will destroy the drive. Be sure to perform a final check of all sequence wiring and other connections before turning on the power and also check for short circuits on the control terminals, which may damage the drive.

Selecting a Circuit Breaker or Circuit Interrupter

Yaskawa recommends installing a Ground Fault Circuit Interrupter (GFCI) to the power supply side. The GFCI should be designed for use with AC drives (e.g., Type B according to IEC 60755).

Select a Molded Case Circuit Breaker (MCCB) or GFCI with a rated current 1.5 to 2 times higher than the drive rated input current to avoid nuisance trips caused by harmonics in the drive input current.

Magnetic Contactor Installation

WARNING! Fire Hazard. Shut off the drive with a magnetic contactor (MC) when a fault occurs in any external equipment such as braking resistors. Failure to comply may cause resistor overheating, fire, and injury to personnel.

NOTICE: To get the full performance life out of the electrolytic capacitors and circuit relays, refrain from switching the drive power supply off and on more than once every 30 minutes. Frequent use can damage the drive. Use the drive to stop and start the motor.

Inspection and Maintenance

WARNING! Electrical Shock Hazard. Capacitors in the drive do not immediately discharge after shutting off the power. Wait for at least the amount of time specified on the drive before touching any components after shutting off the power. Failure to comply may cause injury to personnel from electrical shock.

WARNING! Burn Hazard. Because the heatsink can get very hot during operation, take proper precautions to prevent burns. When replacing the cooling fan, shut off the power and wait at least 15 minutes to be sure that the heatsink has cooled down. Failure to comply may cause burn injury to personnel.

Wiring

Yaskawa recommends using ring terminals on all drive models. Drive models 2A0069 to 2A0415 and 4A0058 to 4A0675 require the use of use ring terminals for UL/cUL compliance. Use only the tools recommended by the terminal manufacturer for crimping.

Transporting the Drive

NOTICE: Never steam clean the drive. During transport, keep the drive from coming into contact with salts, fluorine, bromine, phthalate ester, and other such harmful chemicals.

◆ Motor Application Precautions

■ Standard Induction Motors

Low-Speed Range

The cooling fan of a standard motor should sufficiently cool the motor at the rated speed. As the self-cooling capability of such a motor reduces with the speed, applying full torque at low speed will possibly damage the motor. Reduce the load torque as the motor slows to prevent motor damage from overheating. [Figure i.2](#) shows the allowable load characteristics for a Yaskawa standard motor. Use a motor designed specifically for operation with a drive when 100% continuous torque is needed at low speeds.

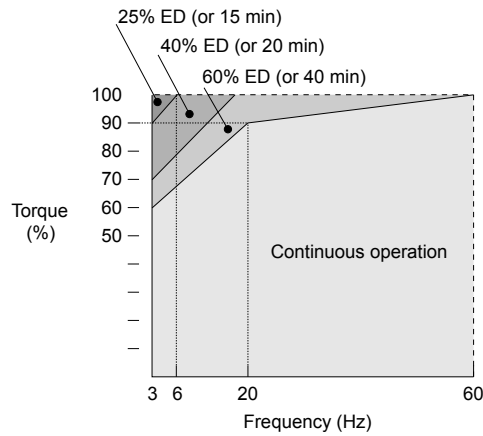

Figure i.2 Allowable Load Characteristics for a Yaskawa Motor

Insulation Tolerance

NOTICE: Consider motor voltage tolerance levels and motor insulation in applications with an input voltage of over 440 V or particularly long wiring distances.

High-Speed Operation

NOTICE: Problems may occur with the motor bearings and dynamic balance of the machine when operating a motor beyond its rated speed. Contact the motor or machine manufacturer.

Torque Characteristics

Torque characteristics differ compared to operating the motor directly from line power. The user should have a full understanding of the load torque characteristics for the application.

Vibration and Shock

The drive allows selection of high carrier PWM control and low carrier PWM. Selecting high carrier PWM can help reduce motor oscillation.

Take particular caution when adding a variable speed drive to an application running a motor from line power at a constant speed. If resonance occurs, install shock-absorbing rubber around the base of the motor and enable the Jump frequency selection to prevent continuous operation in the resonant frequency range.

Audible Noise

Noise created during run varies by the carrier frequency setting. When using a high carrier frequency, audible noise from the motor is comparable to the motor noise generated when running from line power. Operating above the rated motor speed can create unpleasant motor noise.

■ Synchronous Motors

- Contact Yaskawa or a Yaskawa agent when planning to use a synchronous motor not endorsed by Yaskawa.
- Use a standard induction motor when running multiple synchronous motors simultaneously. A single drive does not have this capability.
- A synchronous motor may rotate slightly in the opposite direction of the Run command at start depending on parameter settings and rotor position.
- The amount of generated starting torque differs depending on the control mode and motor type. Set up the motor with the drive after verifying the starting torque, allowable load characteristics, impact load tolerance, and speed control range.

Contact Yaskawa or a Yaskawa agent when planning to use a motor that does not fall within these specifications:

- To restart a coasting motor rotating over 200 Hz while in V/f Control, first use the Short Circuit Braking function to bring the motor to a stop. Short Circuit Braking requires a special braking resistor. Contact Yaskawa or a Yaskawa agent for details.
- To restart a coasting motor rotating below 200 Hz, use the Speed Search function if the motor cable is not too long. If the motor cable is relatively long, stop the motor using Short Circuit Braking.

■ Specialized Motors

Multi-Pole Motor

The rated current of a multi-pole motor differs from that of a standard motor, so be sure to check the maximum current when selecting a drive. Always stop the motor before switching between the number of motor poles. The motor will coast to stop if a regen overvoltage (ov) fault occurs or if overcurrent (oC) protection is triggered.

Submersible Motor

The rated current of a submersible motor is greater than that of a standard motor, so select the drive capacity accordingly. Use a motor cable large enough to avoid decreasing the maximum torque level from voltage drop caused by a long motor cable.

Explosion-Proof Motor

The motor and the drive must be tested together to be certified as explosion-proof. The drive is not designed for explosion-proof areas.

When attaching an encoder to an explosion-proof motor, make sure the encoder is also explosion-proof. Use an insulating signal converter to connect the encoder signal lines to the speed feedback option card.

Geared Motor

Make sure that the gear and the lubricant are rated for the desired speed range to avoid gear damage when operating at low speeds or very high speeds. Consult with the manufacturer for applications that require operation outside the rated speed range of the motor or gear box.

Single-Phase Motor

Variable speed drives are not designed to operate with single phase motors. Using capacitors to start the motor causes excessive current to flow and can damage drive components. A split-phase start or a repulsion start can burn out the starter coils because the internal centrifugal switch is not activated. The drive is for use with three-phase motors only.

Motor with Brake

Take caution when using the drive to operate a motor with a built-in holding brake. If the brake is connected to the output side of the drive, it may not release at start due to low voltage levels, so be sure to install a separate power supply for the motor brake. Note that motors with built-in brakes tend to generate a fair amount of noise when running at low speeds.

■ Notes on Power Transmission Machinery

Installing an AC drive in machinery that was previously connected directly to the power supply will allow the machine to operate at variable speeds. Continuous operation outside of the rated speeds can wear on lubrication material in gear boxes and other power transmission parts. Make sure that lubrication is sufficient within the entire speed range to avoid machine damage. Note that operation above the rated speed can increase the noise generated by the machine.

◆ Drive Label Warning Example

Always heed the warning information listed in *Figure i.3* in the position shown in *Figure i.4*.

⚠ WARNING

⚡ Risk of electric shock.

- Read manual before installing.
- Wait 5 minutes for capacitor discharge after disconnecting power supply.
- To conform to **CE** requirements, make sure to ground the supply neutral for 400V class.
- After opening the manual switch between the drive and motor, please wait 5 minutes before inspecting, performing maintenance or wiring the drive.

🔥 Hot surfaces

- Top and Side surfaces may become hot. Do not touch.

Figure i.3 Warning Information Example

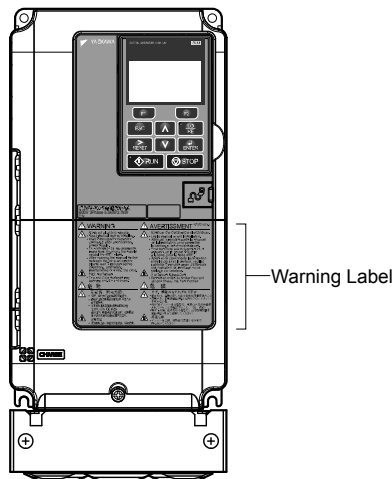

Figure i.4 Warning Information Position

◆ Warranty Information

■ Restrictions

The drive is not designed or manufactured for use in devices or systems that may directly affect or threaten human lives or health.

Customers who intend to use the product described in this manual for devices or systems relating to transportation, health care, space aviation, atomic power, electric power, or in underwater applications must first contact their Yaskawa representatives or the nearest Yaskawa sales office.

WARNING! Injury to Personnel. *This product has been manufactured under strict quality-control guidelines. However, if this product is to be installed in any location where failure of this product could involve or result in a life-and-death situation or loss of human life or in a facility where failure may cause a serious accident or physical injury, safety devices must be installed to minimize the likelihood of any accident.*

Receiving

This chapter explains how to inspect the drive upon receipt, and gives an overview of the different enclosure types and components.

1.1	MODEL NUMBER AND NAMEPLATE CHECK.....	22
------------	--	-----------

1.1 Model Number and Nameplate Check

Please perform the following tasks after receiving the drive:

- Inspect the drive for damage.
If the drive appears damaged upon receipt, contact the shipper immediately.
- Verify receipt of the correct model by checking the information on the nameplate.
- If you have received the wrong model or the drive does not function properly, contact your supplier.

◆ Nameplate

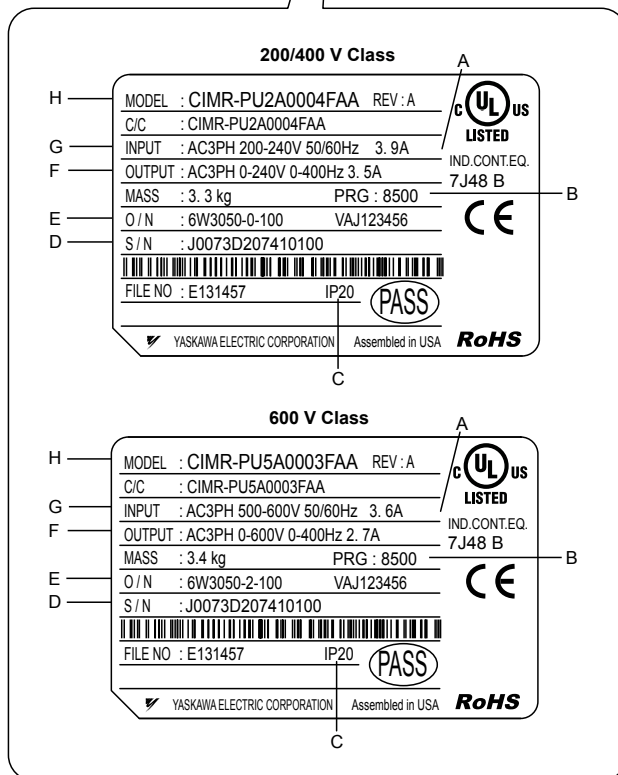
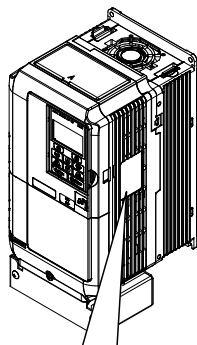

A – Normal Duty Amps
B – Software version
C – Enclosure type
D – Serial number

E – Lot number
F – Output specifications
G – Input specifications
H – AC drive model

Figure 1.1 Nameplate Information Example

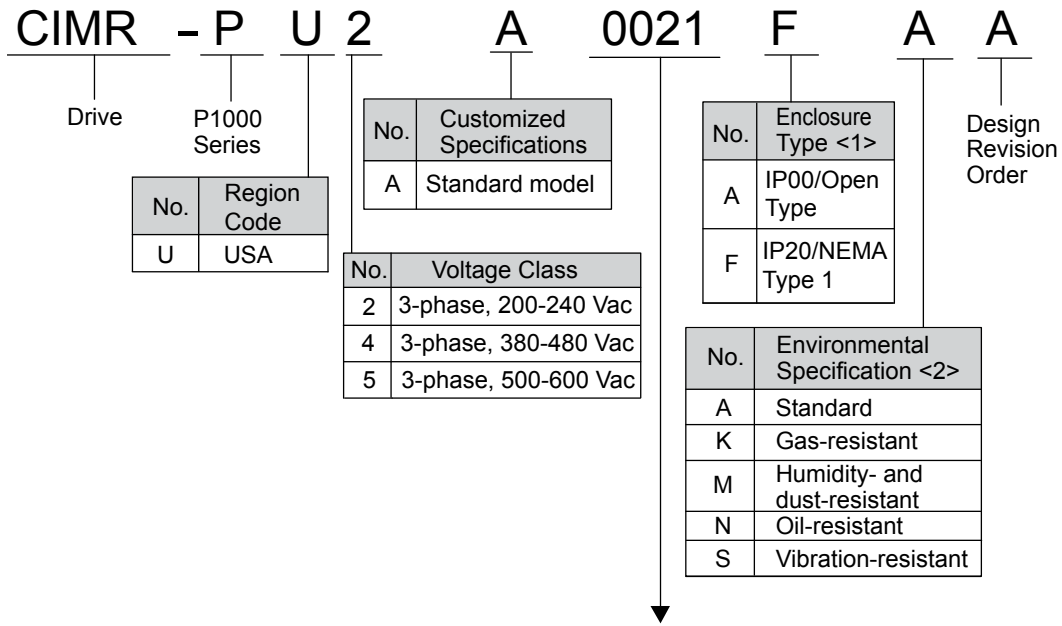

Refer to the tables below

<1> Refer to *Mechanical Installation on page 26* for differences regarding enclosure protection types and component descriptions.

<2> Drives with these specifications do not guarantee complete protection for the environmental conditions indicated.

■ Three-Phase 200 V

Table 1.1 Model Number and Specifications (200 V)

Drive Model	Max. Motor Capacity kW (HP)	Rated Output Current A
2A0004	0.75 (0.75)	3.5
2A0006	1.1 (1)	6.0
2A0008	1.5 (2)	8.0
2A0010	2.2 (3)	9.6
2A0012	3.0 (3)	12
2A0018	3.7 (5)	17.5
2A0021	5.5 (7.5)	21
2A0030	7.5 (10)	30
2A0040	11 (15)	40
2A0056	15 (20)	56
2A0069	18.5 (25)	69
2A0081	22 (30)	81
2A0110	30 (40)	110
2A0138	37 (50)	138
2A0169	45 (60)	169
2A0211	55 (75)	211
2A0250	75 (100)	250
2A0312	90 (125)	312
2A0360	110 (150)	360
2A0415	110 (175)	415

1.1 Model Number and Nameplate Check

■ Three-Phase 400 V

Table 1.2 Model Number and Specifications (400 V)

Drive Model	Max. Motor Capacity kW (HP)	Rated Output Current A
4A0002	0.75 (0.75)	2.1
4A0004	1.5 (2)	4.1
4A0005	2.2 (3)	5.4
4A0007	3.0 (3)	6.9
4A0009	3.7 (5)	8.8
4A0011	5.5 (7.5)	11.1
4A0018	7.5 (10)	17.5
4A0023	11 (15)	23
4A0031	15 (20)	31
4A0038	18.5 (25)	38
4A0044	22 (30)	44
4A0058	30 (40)	58
4A0072	37 (50)	72
4A0088	45 (60)	88
4A0103	55 (75)	103
4A0139	75 (100)	139
4A0165	90 (125)	165
4A0208	110 (150)	208
4A0250	132 (200)	250
4A0296	160 (250)	296
4A0362	185 (300)	362
4A0414	220 (350)	414
4A0515	250 (400-450)	515
4A0675	355 (500-550)	675

■ Three-Phase 600 V

Table 1.3 Model Number and Specifications (600 V)

Drive Model	Max. Motor Capacity kW (HP)	Rated Output Current A
5A0003	1.5 (2)	2.7
5A0004	2.2 (3)	3.9
5A0006	3.7 (5)	6.1
5A0009	5.5 (7.5)	9
5A0011	7.5 (10)	11
5A0017	11 (15)	17
5A0022	15 (20)	22
5A0027	18.5 (25)	27
5A0032	22 (30)	32
5A0041	30 (40)	41
5A0052	37 (50)	52
5A0062	45 (60)	62
5A0077	55 (75)	77
5A0099	75 (100)	99
5A0125	90 (125)	125
5A0145	110 (150)	145
5A0192	160 (200)	192
5A0242	185 (250)	242

Mechanical Installation

This chapter explains how to properly mount and install the drive.

2.1	MECHANICAL INSTALLATION.....	26
------------	-------------------------------------	-----------

2.1 Mechanical Installation

This section outlines specifications, procedures, and the environment for proper mechanical installation of the drive.

◆ Installation Environment

Install the drive in an environment matching the specifications in [Table 2.1](#) to help prolong the optimum performance life of the drive.

Table 2.1 Installation Environment

Environment	Conditions
Installation Area	Indoors
Ambient Temperature	-10 °C to +40 °C (IP20/NEMA Type 1 enclosure) -10 °C to +50 °C (IP00/Open Type enclosure) Drive reliability improves in environments without wide temperature fluctuations. When using the drive in an enclosure panel, install a cooling fan or air conditioner in the area to ensure that the air temperature inside the enclosure does not exceed the specified levels. Do not allow ice to develop on the drive.
Humidity	95% RH or less and free of condensation
Storage Temperature	-20 to +60 °C
Surrounding Area	Install the drive in an area free from: <ul style="list-style-type: none"> • oil mist and dust • metal shavings, oil, water, or other foreign materials • radioactive materials • combustible materials (e.g., wood) • harmful gases and liquids • excessive vibration • chlorides • direct sunlight.
Altitude	1000 m or lower, up to 3000 m with derating
Vibration	10 to 20 Hz at 9.8 m/s ² 20 to 55 Hz at 5.9 m/s ² (Models 2A0004 to 2A0211, 4A0002 to 4A0165, and 5A0003 to 5A0099) or 2.0 m/s ² (Models 2A0250 to 2A0415, 4A0208 to 4A0675, and 5A0125 to 5A0242)
Orientation	Install the drive vertically to maintain maximum cooling effects.

NOTICE: Avoid placing drive peripheral devices, transformers, or other electronics near the drive as the noise created can lead to erroneous operation. If such devices must be used in close proximity to the drive, take proper steps to shield the drive from noise.

NOTICE: Prevent foreign matter such as metal shavings and wire clippings from falling into the drive during installation. Failure to comply could result in damage to the drive. Place a temporary cover over the top of the drive during installation. Remove the temporary cover before drive start-up, as the cover will reduce ventilation and cause the drive to overheat.

◆ Installation Orientation and Spacing

Install the drive upright as illustrated in [Figure 2.1](#) to maintain proper cooling.

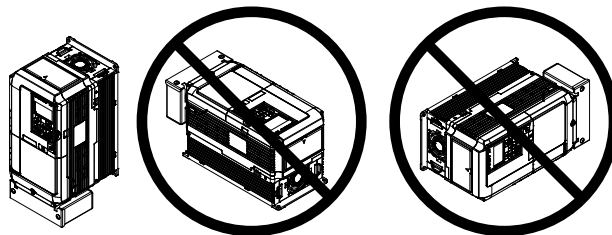

Figure 2.1 Correct Installation Orientation

Single Drive Installation

Figure 2.2 shows the installation distance required to maintain sufficient space for airflow and wiring. Install the heatsink against a closed surface to avoid diverting cooling air around the heatsink.

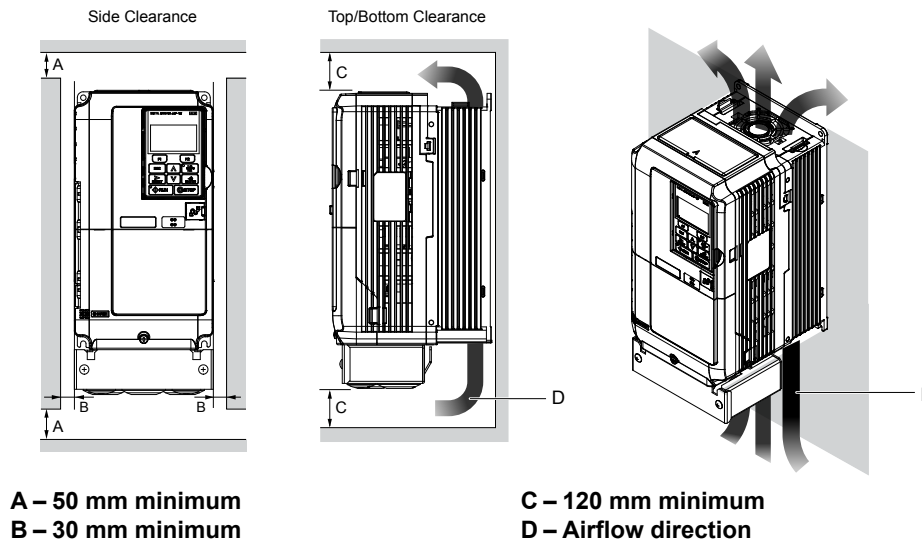

Figure 2.2 Correct Installation Spacing

Note: IP20/NEMA Type 1 enclosure and IP00/Open Type enclosure models require the same amount of space above and below the drive for installation.

Multiple Drive Installation (Side-by-Side Installation)

Models 2A0004 to 2A0081, 4A0002 to 4A0044, and 5A0003 to 5A0032 can take advantage of Side-by-Side installation. When installing multiple drives into the same enclosure panel, mount the drives according to Figure 2.2.

When mounting drives with the minimum clearance of 2 mm according to Figure 2.3, set parameter L8-35 to 1 while considering derating. Refer to Parameter List on page 177 for details..

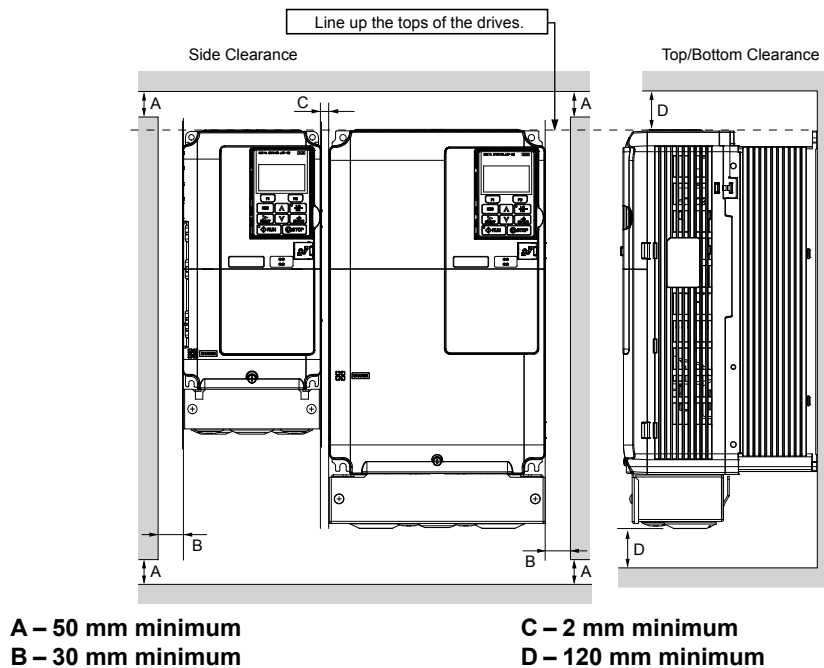

Figure 2.3 Space Between Drives (Side-by-Side Mounting)

Note: Align the tops of the drives when installing drives of different heights in the same enclosure panel. Leave space between the tops and bottoms of stacked drives for easier cooling fan replacement.

Remove the top protective covers of all drives as shown in Figure 2.4 when mounting IP20/NEMA Type 1 enclosure drives side-by-side. Refer to Top Protective Cover on page 48 to remove and reattach the top protective cover.

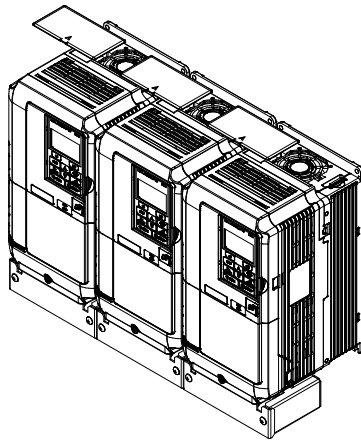

Figure 2.4 IP20/NEMA 1 Side-by-Side Mounting in Enclosure

■ IP20/NEMA Type 1 Enclosure Drives

Note: Removing the top protective cover or bottom conduit bracket from an IP20/NEMA Type 1 enclosure drive voids NEMA Type 1 protection while maintaining IP20 conformity.

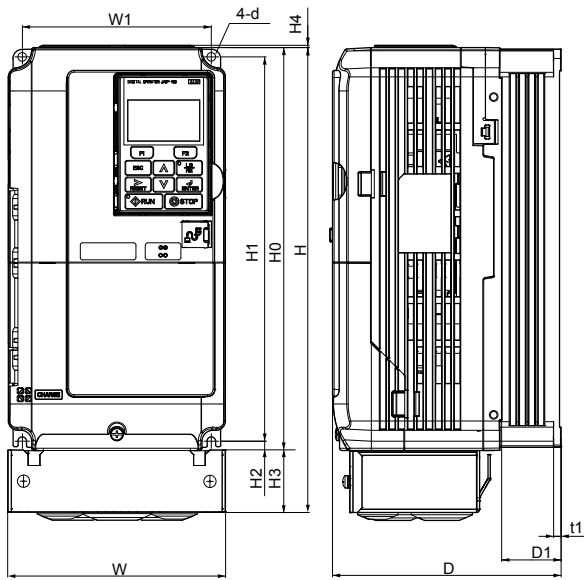

Figure 1

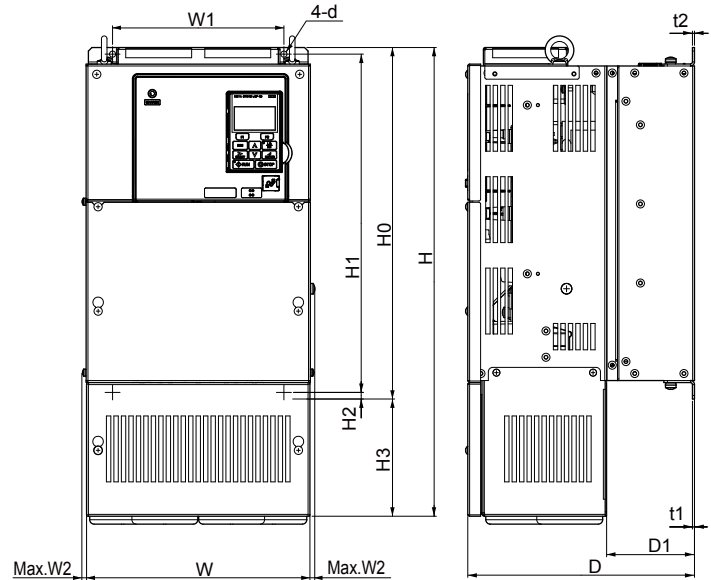

Figure 2

Table 2.2 Dimensions for IP20/NEMA Type 1 Enclosure: 200 V Class

Drive Model	Dimensions (in)															
	Figure	W	H	D	W1	W2	H0	H1	H2	H3	H4	D1	t1	t2	d	Wt. (lb)
2A0004F	1 </>	5.51	11.81	5.79	4.80	–	10.24	9.76	0.24	1.57	0.06	1.50	0.20	–	M5	7.3
2A0006F		5.51	11.81	5.79	4.80	–	10.24	9.76	0.24	1.57	0.06	1.50	0.20	–	M5	7.3
2A0008F		5.51	11.81	5.79	4.80	–	10.24	9.76	0.24	1.57	0.06	1.50	0.20	–	M5	7.5
2A0010F		5.51	11.81	5.79	4.80	–	10.24	9.76	0.24	1.57	0.06	1.50	0.20	–	M5	7.5
2A0012F		5.51	11.81	5.79	4.80	–	10.24	9.76	0.24	1.57	0.06	1.50	0.20	–	M5	7.5
2A0018F		5.51	11.81	6.46	4.80	–	10.24	9.76	0.24	1.57	0.06	2.17	0.20	–	M5	8.2
2A0021F		5.51	11.81	6.46	4.80	–	10.24	9.76	0.24	1.57	0.06	2.17	0.20	–	M5	8.2
2A0030F		5.51	11.81	6.57	4.80	–	10.24	9.76	0.24	1.57	0.06	2.17	0.20	–	M5	9.3
2A0040F		5.51	11.81	6.57	4.80	–	10.24	9.76	0.24	1.57	0.06	2.17	0.20	–	M5	9.3
2A0056F		7.09	13.39	7.36	6.30	–	11.81	11.18	0.31	1.57	0.06	2.95	0.20	–	M5	13.0
2A0069F		8.66	15.75	7.76	7.56	–	13.78	13.19	0.31	1.97	0.06	3.07	0.20	–	M6	20.1
2A0081F		8.66	15.75	7.76	7.56	–	13.78	13.19	0.31	1.97	0.06	3.07	0.20	–	M6	22.0
2A0110F	2 </>	10.00	21.02	10.16	7.68	0.31	15.75	15.16	0.30	5.28	–	3.94	0.09	0.09	M6	50.7
2A0138F		10.98	24.17	10.16	8.66	0.31	17.72	17.13	0.30	6.46	–	3.94	0.09	0.09	M6	61.7
2A0169F		12.95	28.74	11.14	10.24	0.31	21.65	21.06	0.30	7.09	–	4.33	0.09	0.09	M6	90.4
2A0211F		12.95	28.74	11.14	10.24	0.31	21.65	21.06	0.30	7.09	–	4.33	0.09	0.09	M6	92.6
Dimensions below are the dimensions of IP00/Open Type models after customer installation of the appropriate IP20/NEMA Type 1 Kit.																
2A0250A	2	17.95	37.80	12.99	12.80	0.31	27.76	26.77	0.49	10.04	–	5.12	0.13	0.13	M10	183.0
2A0312A		17.95	37.80	12.99	12.80	0.31	27.76	26.77	0.49	10.04	–	5.12	0.13	0.13	M10	194.0
2A0360A		19.84	45.98	13.78	14.57	0.31	31.50	30.43	0.51	14.49	–	5.12	0.18	0.18	M12	238.1

<1> Removing the top protective cover from a IP20/NEMA Type 1 enclosure drive voids NEMA Type 1 protection while retaining IP20 conformity.

2.1 Mechanical Installation

Table 2.3 Dimensions for IP20/NEMA Type 1 Enclosure: 400 V Class

Drive Model	Dimensions (in)															
	Figure	W	H	D	W1	W2	H0	H1	H2	H3	H4	D1	t1	t2	d	Wt. (lb)
4A0002F	1 <1>	5.51	11.81	5.79	4.80	–	10.24	9.76	0.24	1.57	0.06	1.50	0.20	–	M5	7.5
4A0004F		5.51	11.81	5.79	4.80	–	10.24	9.76	0.24	1.57	0.06	1.50	0.20	–	M5	7.5
4A0005F		5.51	11.81	5.79	4.80	–	10.24	9.76	0.24	1.57	0.06	1.50	0.20	–	M5	7.5
4A0007F		5.51	11.81	6.46	4.80	–	10.24	9.76	0.24	1.57	0.06	2.17	0.20	–	M5	7.9
4A0009F		5.51	11.81	6.46	4.80	–	10.24	9.76	0.24	1.57	0.06	2.17	0.20	–	M5	8.2
4A0011F		5.51	11.81	6.46	4.80	–	10.24	9.76	0.24	1.57	0.06	2.17	0.20	–	M5	8.2
4A0018F		5.51	11.81	6.57	4.80	–	10.24	9.76	0.24	1.57	0.06	2.17	0.20	–	M5	9.0
4A0023F		5.51	11.81	6.57	4.80	–	10.24	9.76	0.24	1.57	0.06	2.17	0.20	–	M5	9.0
4A0031F		7.09	13.39	6.57	6.30	–	11.81	11.18	0.31	1.57	0.06	2.17	0.20	–	M5	12.6
4A0038F		7.09	13.39	7.36	6.30	–	11.81	11.18	0.31	1.57	0.06	2.95	0.20	–	M5	13.2
4A0044F	8.66	15.75	7.76	7.56	–	13.78	13.19	0.31	1.97	0.06	3.07	0.20	–	M6	19.2	
4A0058F	2 <1>	10.00	18.31	10.16	7.68	0.31	15.75	15.16	0.30	2.56	–	3.94	0.09	0.09	M6	50.7
4A0072F		10.98	20.28	10.16	8.66	0.31	17.72	17.13	0.30	2.56	–	3.94	0.09	0.09	M6	59.5
4A0088F		12.95	24.80	10.16	10.24	0.31	20.08	19.49	0.30	4.72	–	4.13	0.09	0.13	M6	86.0
4A0103F		12.95	24.80	10.16	10.24	0.31	20.08	19.49	0.30	4.72	–	4.13	0.09	0.13	M6	86.0
4A0139F		12.95	28.74	11.14	10.24	0.31	21.65	21.06	0.30	7.09	–	4.33	0.09	0.09	M6	99.2
4A0165F		12.95	28.74	11.14	10.24	0.31	21.65	21.06	0.30	7.09	–	4.33	0.09	0.09	M6	101.4
Dimensions below are the dimensions of IP00/Open Type models after customer installation of the appropriate IP20/NEMA Type 1 Kit.																
4A0208A	2	17.95	37.80	12.99	12.80	0.31	27.76	26.77	0.49	10.04	–	5.12	0.13	0.13	M10	191.8
4A0250A		19.84	45.98	13.78	14.57	0.31	31.50	30.43	0.51	14.49	–	5.12	0.18	0.18	M12	233.7
4A0296A		19.84	45.98	13.78	14.57	0.31	31.50	30.43	0.51	14.49	–	5.12	0.18	0.18	M12	246.9
4A0362A		19.84	45.98	13.78	14.57	0.31	31.50	30.43	0.51	14.49	–	5.12	0.18	0.18	M12	257.9

<1> Removing the top protective cover from a IP20/NEMA Type 1 enclosure drive voids NEMA Type 1 protection while retaining IP20 conformity.

Table 2.4 Dimensions for IP20/NEMA Type 1 Enclosure: 600 V Class

Drive Model	Dimensions (in)															
	Figure	W	H	D	W1	W2	H0	H1	H2	H3	H4	D1	t1	t2	d	Wt. (lb)
5A0003F	1 <1>	5.51	11.81	5.79	4.80	–	10.24	9.76	0.24	1.57	0.06	1.50	0.20	–	M5	7.5
5A0004F		5.51	11.81	5.79	4.80	–	10.24	9.76	0.24	1.57	0.06	1.50	0.20	–	M5	7.5
5A0006F		5.51	11.81	6.46	4.80	–	10.24	9.76	0.24	1.57	0.06	2.17	0.20	–	M5	8.2
5A0009F		5.51	11.81	6.46	4.80	–	10.24	9.76	0.24	1.57	0.06	2.17	0.20	–	M5	8.2
5A0011F		5.51	11.81	6.57	4.80	–	10.24	9.76	0.24	1.57	0.06	2.17	0.20	–	M5	9.0
5A0017F		7.09	13.39	7.36	6.30	–	11.81	11.18	0.31	1.57	0.06	2.95	0.20	–	M5	13.2
5A0022F		7.09	13.39	7.36	6.30	–	11.81	11.18	0.31	1.57	0.06	2.95	0.20	–	M5	13.2
5A0027F		8.66	15.75	7.76	7.56	–	13.78	13.19	0.31	1.97	0.06	3.07	0.20	–	M6	19.2
5A0032F		8.66	15.75	7.76	7.56	–	13.78	13.19	0.31	1.97	0.06	3.07	0.20	–	M6	19.2
5A0041F		2	10.98	20.28	10.16	8.66	0.31	17.72	17.13	0.30	2.56	–	3.94	0.09	0.09	M6
5A0052F	10.98		20.28	10.16	8.66	0.31	17.72	17.13	0.30	2.56	–	3.94	0.09	0.09	M6	59.5
5A0062F	12.95		28.74	11.14	10.24	0.31	21.65	21.06	0.30	7.09	–	4.33	0.09	0.09	M6	99.2
5A0077F	12.95		28.74	11.14	10.24	0.31	21.65	21.06	0.30	7.09	–	4.33	0.09	0.09	M6	99.2
5A0099F	12.95		28.74	11.14	10.24	0.31	21.65	21.06	0.30	7.09	–	4.33	0.09	0.09	M6	99.2
Dimensions below are the dimensions of IP00/Open Type models after customer installation of the appropriate IP20/NEMA Type 1 Kit.																
5A0125A	2	17.95	37.80	12.99	12.80	0.31	27.76	26.77	0.49	10.04	–	5.12	0.13	0.13	M10	191.8
5A0145A		17.95	37.80	12.99	12.80	0.31	27.76	26.77	0.49	10.04	–	5.12	0.13	0.13	M10	191.8
5A0192A		19.84	45.98	13.78	14.57	0.31	31.50	30.43	0.51	14.49	–	5.12	0.18	0.18	M12	233.7
5A0242A		19.84	45.98	13.78	14.57	0.31	31.50	30.43	0.51	14.49	–	5.12	0.18	0.18	M12	257.9

<1> Removing the top protective cover or bottom conduit bracket from an IP20/NEMA Type 1 enclosure drive voids NEMA Type 1 protection while maintaining IP20 conformity.

IP20/NEMA Type 1 Enclosure Conduit Bracket Dimensions

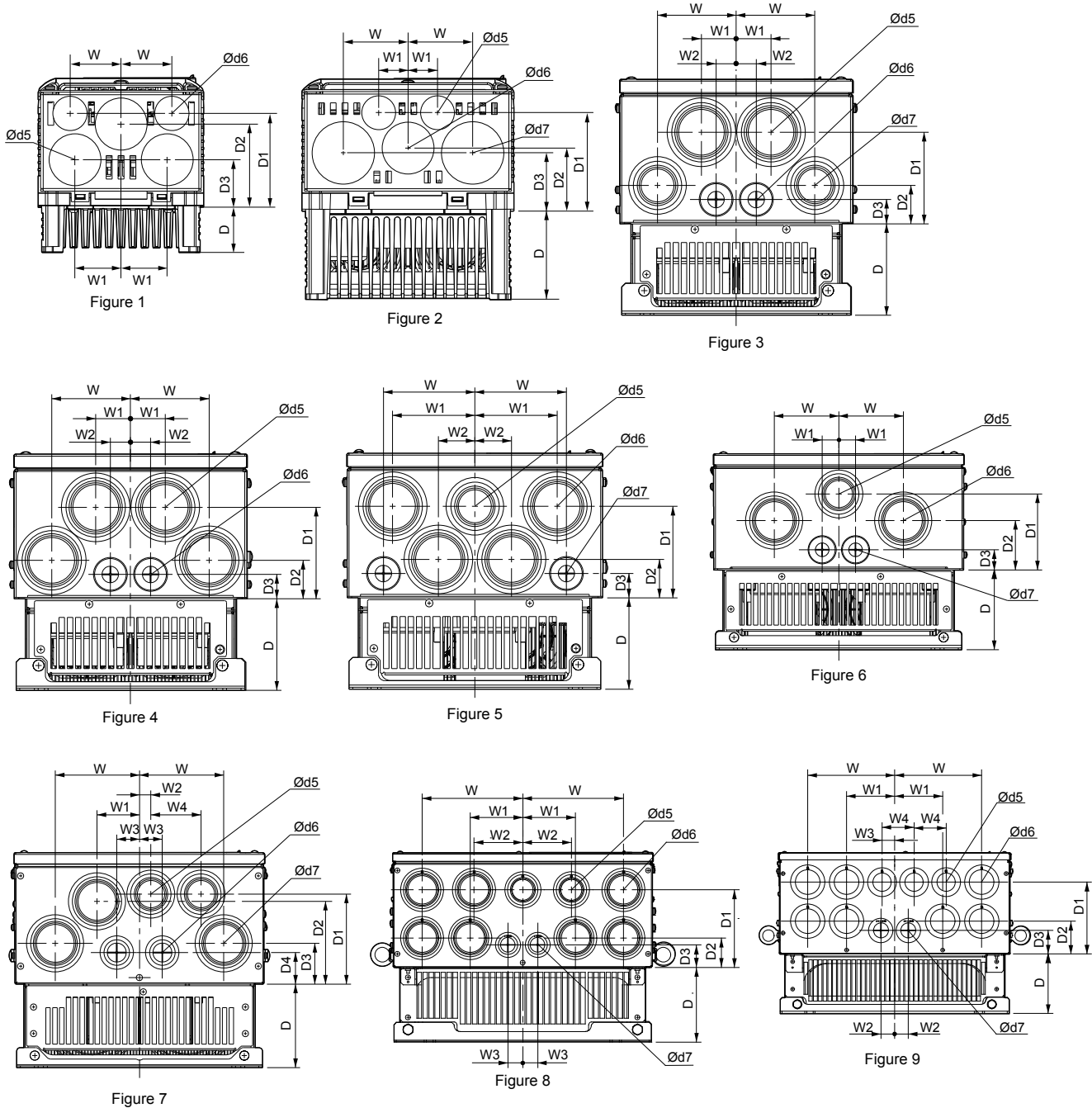

Table 2.5 Conduit Bracket Dimensions for IP20/NEMA Type 1

Drive Model	Dimensions (in)											Diameter (in)		
	Figure	W	D	W1	W2	W3	W4	D1	D2	D3	D4	d5	d6	d7
200 V Class														
2A0004F	1	1.7	1.5	1.5	–	–	–	1.6	2.8	3.1	–	0.9	1.4	–
2A0006F		1.7	1.5	1.5	–	–	–	1.6	2.8	3.1	–	0.9	1.4	–
2A0008F		1.7	1.5	1.5	–	–	–	1.6	2.8	3.1	–	–	–	–
2A0010F		1.7	1.5	1.5	–	–	–	1.6	2.8	3.1	–	0.9	1.4	–
2A0012F		1.7	2.2	1.5	–	–	–	1.6	2.8	3.1	–	0.9	1.4	–

2.1 Mechanical Installation

Drive Model	Dimensions (in)											Diameter (in)		
	Figure	W	D	W1	W2	W3	W4	D1	D2	D3	D4	d5	d6	d7
2A0018F	2	1.7	2.2	1.5	–	–	–	1.6	2.8	3.1	–	1.4	0.9	1.7
2A0021F		1.7	2.2	1.5	–	–	–	1.6	2.8	3.1	–	1.4	0.9	1.7
2A0030F		1.7	2.2	1.5	–	–	–	1.6	2.8	3.1	–	1.4	0.9	1.7
2A0040F		1	3	2.2	–	–	–	1.9	3.3	2.1	–	1.4	0.9	1.7
2A0056F		1	3	2.2	–	–	–	1.9	3.3	2.1	–	1.4	0.9	1.7
2A0069F		1.1	3.1	2.5	–	–	–	2	3.4	2.2	–	1.4	0.9	1.7
2A0081F		1.1	3.1	2.5	–	–	–	2	3.4	2.2	–	1.4	0.9	1.7
2A0110F	4	3.4	3.9	1.5	0.9	–	–	3.9	1.7	1.0	–	2.4	1.1	–
2A0138F	5	3.9	3.9	3.5	1.6	–	–	3.9	1.7	1.0	–	2.0	2.4	1.1
2A0169F	7	4.4	4.3	2.2	0.6	1.2	2.6	4.7	4.3	2.1	1.6	2.0	1.4	2.4
2A0211F		4.4	4.3	2.2	0.6	1.2	2.6	4.7	4.3	2.1	1.6	2.0	1.4	2.4
2A0250A	8	6.9	5.1	3.6	3.3	1.0	–	5.4	2.0	1.6	–	2.0	2.4	1.4
2A0312A		6.9	5.1	3.6	3.3	1.0	–	5.4	2.0	1.6	–	2.0	2.4	1.4
2A0360A	9	7.5	5.1	4.1	1.2	1.1	2.8	6.2	2.8	2.0	–	2.0	2.4	1.7
400 V Class														
4A0002F	1	1.7	1.5	1.5	–	–	–	1.6	2.8	3.1	–	0.9	1.4	–
4A0004F		1.7	1.5	1.5	–	–	–	1.6	2.8	3.1	–	0.9	1.4	–
4A0005F		1.7	1.5	1.5	–	–	–	1.6	2.8	3.1	–	0.9	1.4	–
4A0007F		1.7	2.2	1.5	–	–	–	1.6	2.8	3.1	–	0.9	1.4	–
4A0009F		1.7	2.2	1.5	–	–	–	1.6	2.8	3.1	–	0.9	1.4	–
4A0011F		1.7	2.2	1.5	–	–	–	1.6	2.8	3.1	–	0.9	1.4	–
4A0018F		1.7	2.2	1.5	–	–	–	1.6	2.8	3.1	–	0.9	1.4	–
4A0023F	2	1	3	2.2	–	–	–	1.9	3.3	2.1	–	1.4	0.9	1.7
4A0031F		1	3	2.2	–	–	–	1.9	3.3	2.1	–	1.4	0.9	1.7
4A0038F		1.1	3.1	2.5	–	–	–	2	3.4	2.2	–	1.4	0.9	1.7
4A0044F		1.1	3.1	2.5	–	–	–	2	3.4	2.2	–	1.4	0.9	1.7
4A0058F	3	3.4	3.9	1.5	0.9	–	–	3.9	1.7	1.0	–	2.4	1.1	2.0
4A0072F		3.5	3.9	1.6	0.9	–	–	3.9	1.7	1.0	–	2.4	1.1	2.0
4A0088F	6	3.3	4.1	0.9	–	–	–	3.9	2.6	1.0	–	2.0	2.4	1.1
4A0103F		3.3	4.1	0.9	–	–	–	3.9	2.6	1.0	–	2.0	2.4	1.1
4A0139F	7	4.4	4.3	2.2	0.6	1.2	2.6	4.7	4.3	2.1	1.6	2.0	1.4	2.4
4A0165F		4.4	4.3	2.2	0.6	1.2	2.6	4.7	4.3	2.1	1.6	2.0	1.4	2.4
4A0208A	8	6.9	5.1	3.6	3.3	1.0	–	5.4	2.0	1.6	–	2.0	2.4	1.4
4A0250A	9	7.5	5.1	4.1	1.2	1.1	2.8	6.2	2.8	2.0	–	2.0	2.4	1.7
4A0296A		7.5	5.1	4.1	1.2	1.1	2.8	6.2	2.8	2.0	–	2.0	2.4	1.7
4A0362A		7.5	5.1	4.1	1.2	1.1	2.8	6.2	2.8	2.0	–	2.0	2.4	1.7
600 V Class														
5A0003F	1	1.7	1.5	1.5	–	–	–	1.6	2.8	3.1	–	0.9	1.4	–
5A0004F		1.7	1.5	1.5	–	–	–	1.6	2.8	3.1	–	0.9	1.4	–
5A0006F		1.7	2.2	1.5	–	–	–	1.6	2.8	3.1	–	0.9	1.4	–
5A0009F		1.7	2.2	1.5	–	–	–	1.6	2.8	3.1	–	0.9	1.4	–
5A0011F		1.7	2.2	1.5	–	–	–	1.6	2.8	3.1	–	0.9	1.4	–

Drive Model	Dimensions (in)											Diameter (in)		
	Figure	W	D	W1	W2	W3	W4	D1	D2	D3	D4	d5	d6	d7
5A0017F	2	1	3	2.2	-	-	-	1.9	3.3	2.1	-	1.4	0.9	1.7
5A0022F		1	3	2.2	-	-	-	1.9	3.3	2.1	-	1.4	0.9	1.7
5A0027F		1.1	3.1	2.5	-	-	-	2	3.4	2.2	-	1.4	0.9	1.7
5A0032F		1.1	3.1	2.5	-	-	-	2	3.4	2.2	-	1.4	0.9	1.7
5A0041F	3	3.5	3.9	1.6	0.9	-	-	3.9	1.7	1.0	-	2.4	1.1	2.0
5A0052F		3.5	3.9	1.6	0.9	-	-	3.9	1.7	1.0	-	2.4	1.1	2.0
5A0062F	7	4.4	4.3	2.2	0.6	1.2	2.6	4.7	4.3	2.1	1.6	2.0	1.4	2.4
5A0077F		4.4	4.3	2.2	0.6	1.2	2.6	4.7	4.3	2.1	1.6	2.0	1.4	2.4
5A0099F		4.4	4.3	2.2	0.6	1.2	2.6	4.7	4.3	2.1	1.6	2.0	1.4	2.4
5A0125A	8	6.9	5.1	3.6	3.3	1.0	-	5.4	2.0	1.6	-	2.0	2.4	1.4
5A0145A		6.9	5.1	3.6	3.3	1.0	-	5.4	2.0	1.6	-	2.0	2.4	1.4
5A0192A	9	7.5	5.1	4.1	1.2	1.1	2.8	6.2	2.8	2.0	-	2.0	2.4	1.7
5A0242A		7.5	5.1	4.1	1.2	1.1	2.8	6.2	2.8	2.0	-	2.0	2.4	1.7

Note: Removing the top protective cover or bottom conduit bracket from an IP20/NEMA Type 1 enclosure drive voids NEMA Type 1 protection while maintaining IP20 conformity.

■ IP00/Open Type Enclosure Drives

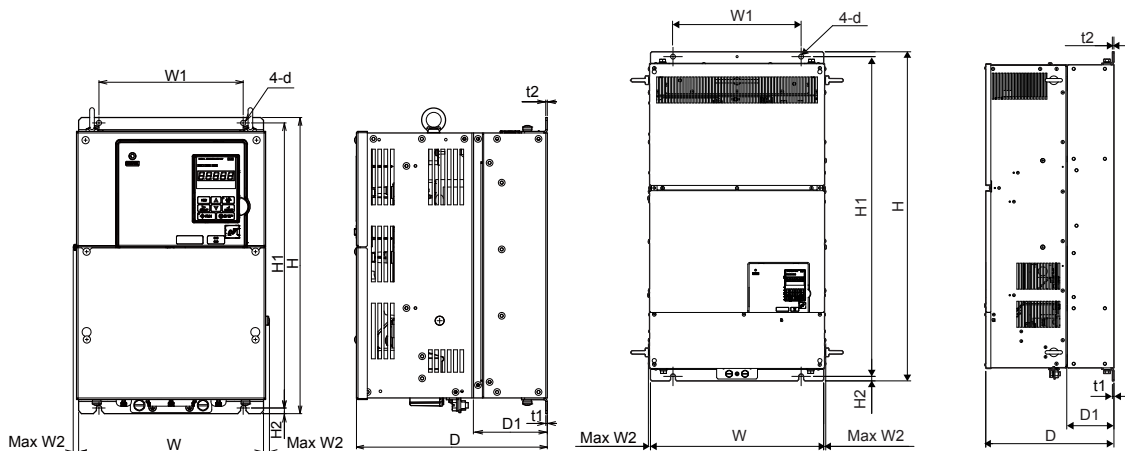

Figure 1

Figure 2

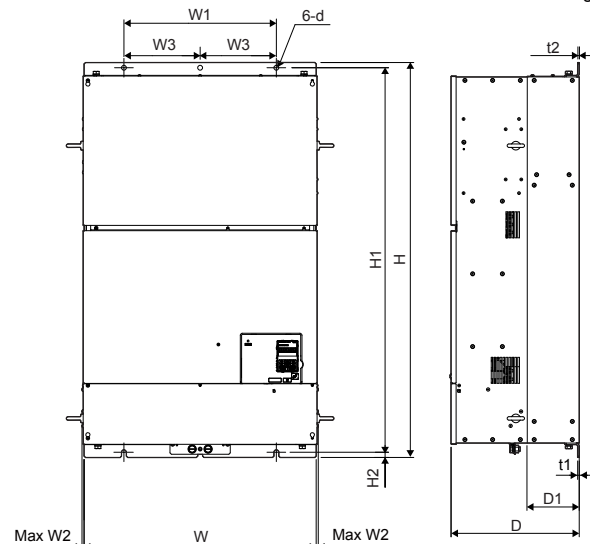

Figure 3

2.1 Mechanical Installation

Table 2.6 Dimensions for IP00/Open Type Enclosure: 200 V Class

Drive Model	Dimensions (in)												
	Figure	W	H	D	W1	W2	H1	H2	D1	t1	t2	d	Wt. (lb)
2A0250A </>	1	17.72	27.76	12.99	12.80	0.39	26.77	0.49	5.12	0.13	0.13	M10	167.6
2A0312A </>		17.72	27.76	12.99	12.80	0.39	26.77	0.49	5.12	0.13	0.13	M10	176.4
2A0360A </>		19.69	31.50	13.78	14.57	0.39	30.43	0.51	5.12	0.18	0.18	M12	216.1
2A0415A		19.69	31.50	13.78	14.57	0.39	30.43	0.51	5.12	0.18	0.18	M12	218.3

<1> Customers may convert these models to IP20/NEMA Type 1 enclosures using an IP20/NEMA Type 1 Kit. [Refer to IP20/NEMA Type 1 Kit Selection on page 35](#) to select the appropriate kit.

Table 2.7 Dimensions for IP00/Open Type Enclosure: 400 V Class

Drive Model	Dimensions (in)														
	Figure	W	H	D	W1	W2	W3	W4	H1	H2	D1	t1	t2	d	Wt. (lb)
4A0208A </>	1	17.72	27.76	12.99	12.80	0.39	–	–	26.77	0.49	5.12	0.13	0.13	M10	174.2
4A0250A </>		19.69	31.50	13.78	14.57	0.39	–	–	30.43	0.51	5.12	0.18	0.18	M12	211.6
4A0296A </>		19.69	31.50	13.78	14.57	0.39	–	–	30.43	0.51	5.12	0.18	0.18	M12	224.9
4A0362A </>		19.69	31.50	13.78	14.57	0.39	–	–	30.43	0.51	5.12	0.18	0.18	M12	235.9
4A0414A	2	19.69	37.40	14.57	14.57	0.31	–	–	36.34	0.51	5.31	0.18	0.18	M12	275.6
4A0515A	3	26.38	44.88	14.57	17.32	0.24	8.66	–	43.70	0.59	5.91	0.18	0.18	M12	476.2
4A0675A		26.38	44.88	14.57	17.32	0.24	8.66	–	43.70	0.59	5.91	0.18	0.18	M12	487.2

<1> Customers may convert these models to IP20/NEMA Type 1 enclosures using an IP20/NEMA Type 1 Kit. [Refer to IP20/NEMA Type 1 Kit Selection on page 35](#) to select the appropriate kit.

Table 2.8 Dimensions for IP00/Open Type Enclosure: 600 V Class

Drive Model	Dimensions (in)														
	Figure	W	H	D	W1	W2	W3	W4	H1	H2	D1	t1	t2	d	Wt. (lb)
5A0125A </>	1	17.72	27.76	12.99	12.80	0.39	–	–	26.77	0.49	5.12	0.13	0.13	M10	174.2
5A0145A </>		17.72	27.76	12.99	12.80	0.39	–	–	26.77	0.49	5.12	0.13	0.13	M10	174.2
5A0192A </>		19.69	31.50	13.78	14.57	0.39	–	–	30.43	0.51	5.12	0.18	0.18	M12	235.9
5A0242A </>		19.69	31.50	13.78	14.57	0.39	–	–	30.43	0.51	5.12	0.18	0.18	M12	235.9

<1> Customers may convert these models to IP20/NEMA Type 1 enclosures using an IP20/NEMA Type 1 Kit. [Refer to IP20/NEMA Type 1 Kit Selection on page 35](#) to select the appropriate kit.

IP20/NEMA Type 1 Kit Selection

Customers may convert IP00/Open Type models to IP20/NEMA Type 1 enclosures. Refer to [Table 2.9](#) to select the appropriate IP20/NEMA Type 1 Kit when performing the conversion.

Contact a Yaskawa representative for IP20/NEMA Type 1 Kit availability for IP00/Open Type models not listed.

Table 2.9 IP20/NEMA Type 1 Kit Selection

IP00/Open Type Drive Model	IP20/NEMA Type 1 Kit Code	Comments
2A0250A	100-054-503	<i>Refer to IP20/NEMA Type 1 Enclosure Drives on page 29</i> for drive dimensions with the IP20/NEMA Type 1 Kit installed.
2A0312A		
2A0360A		
4A0208A		
4A0250A	100-054-504	
4A0296A		
4A0362A		
5A0125A	100-054-503	
5A0145A		
5A0192A	100-054-504	
5A0242A		

This Page Intentionally Blank

Electrical Installation

This chapter explains proper procedures for wiring the control circuit terminals, motor, and power supply.

3.1	STANDARD CONNECTION DIAGRAM.....	38
3.2	MAIN CIRCUIT CONNECTION DIAGRAM.....	41
3.3	TERMINAL COVER.....	43
3.4	DIGITAL OPERATOR AND FRONT COVER.....	45
3.5	TOP PROTECTIVE COVER.....	48
3.6	MAIN CIRCUIT WIRING.....	49
3.7	CONTROL CIRCUIT WIRING.....	60
3.8	CONTROL I/O CONNECTIONS.....	65
3.9	CONNECT TO A PC.....	69
3.10	WIRING CHECKLIST.....	70

3.1 Standard Connection Diagram

Connect the drive and peripheral devices as shown in [Figure 3.1](#). It is possible to set and run the drive via the digital operator without connecting digital I/O wiring. This section does not discuss drive operation; [Refer to Start-Up Programming & Operation on page 71](#) for instructions on operating the drive.

NOTICE: *Inadequate wiring could result in damage to the drive. Install adequate branch circuit short circuit protection per applicable codes. The drive is suitable for circuits capable of delivering not more than 100,000 RMS symmetrical amperes, 240 Vac maximum (200 V class), 480 Vac maximum (400 V class), 600 Vac maximum (600 V class).*

NOTICE: *When the input voltage is 440 V or higher or the wiring distance is greater than 100 meters, pay special attention to the motor insulation voltage or use a drive duty motor. Failure to comply could lead to motor insulation breakdown.*

NOTICE: *Do not connect AC control circuit ground to drive enclosure. Improper drive grounding can cause control circuit malfunction.*

Note: The minimum load for the relay outputs M1-M2, M3-M4, MA-MB-MC, and MD-ME-MF is 10 mA.

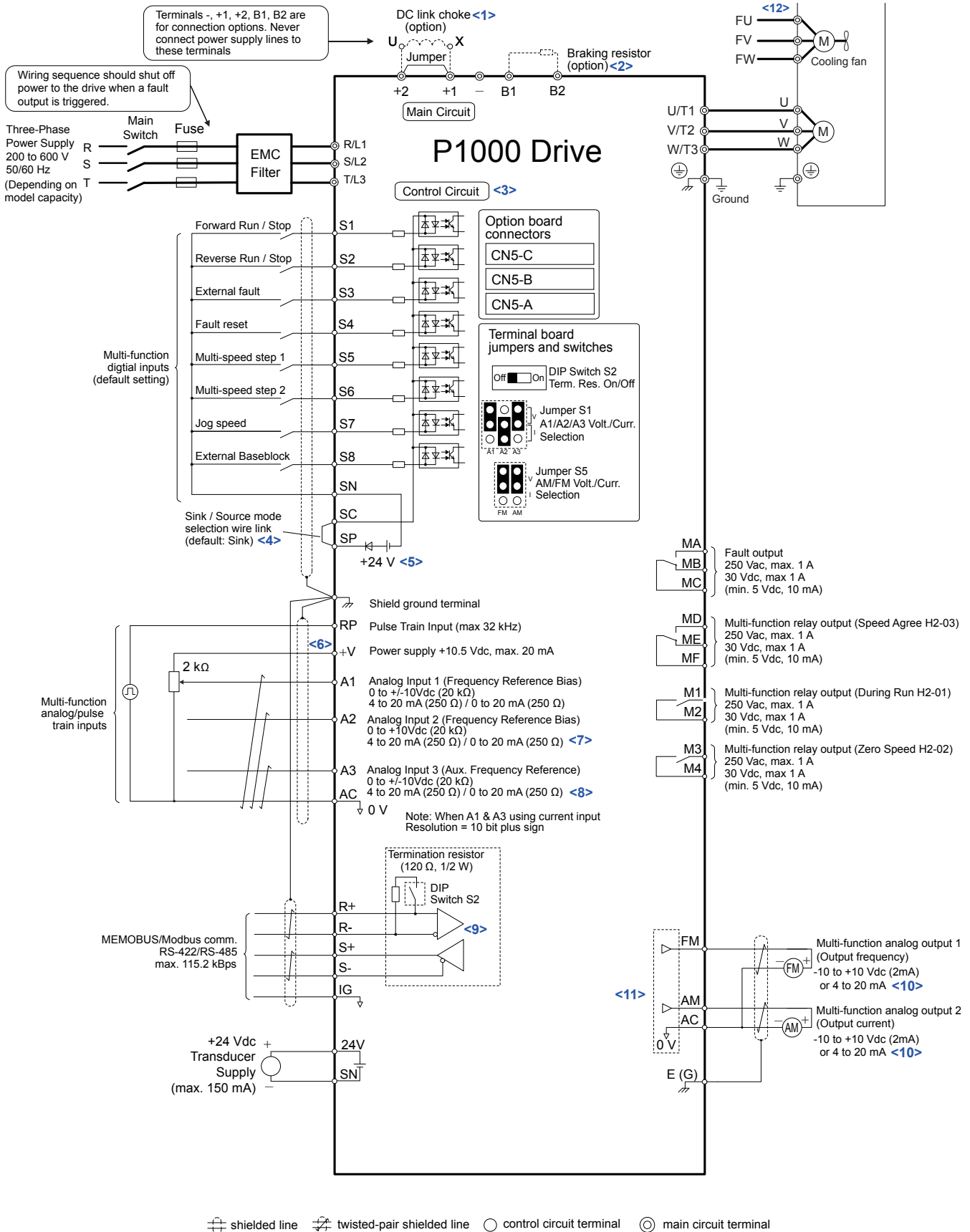

Figure 3.1 Drive Standard Connection Diagram (example: model 2A0040)

<1> Remove the jumper when installing a DC link choke. Models 2A0110 to 2A0415 and 4A0058 to 4A0675 come with a built-in DC link choke.

3.1 Standard Connection Diagram

- <2> Set L8-55 to 0 to disable the protection function of the built-in braking transistor of the drive when using an optional regenerative converter or dynamic braking option. Leaving L8-55 enabled may cause a braking resistor fault (rF). Additionally, disable Stall Prevention (L3-04 = 0) when using an optional regenerative converter, regenerative or braking units, or dynamic braking option. Leaving L3-04 enabled may prevent the drive from stopping within the specified deceleration time.
- <3> Supplying power to the control circuit separately from the main circuit requires 24 V power supply (option).
- <4> This figure illustrates an example of a sequence input to S1 through S8 using a non-powered relay or an NPN transistor. Install the wire link between terminals SC-SP for Sink mode, between SC-SN for Source mode, or leave the link out for external power supply. Never short terminals SP and SN, as it will damage the drive.
- <5> This voltage source supplies a maximum current of 150 mA.
- <6> The maximum output current capacity for the +V terminal on the control circuit is 20 mA. Never short terminals +V and AC, as it can cause erroneous operation or damage the drive.
- <7> Set jumper S1 to select between a voltage or current input signal to terminal A2. The default setting is for current input.
- <8> Set jumper S1 to select between a voltage or current input signal to terminal A1 and A3. The default setting is for voltage input.
- <9> Set DIP switch S2 to the ON position to enable the termination resistor in the last drive in a MEMOBUS/Modbus network.
- <10> Monitor outputs work with devices such as analog frequency meters, ammeters, voltmeters, and wattmeters. They are not intended for use as a feedback-type signal.
- <11> Use jumper S5 to select between voltage or current output signals at terminals AM and FM. Set parameters H4-07 and H4-08 accordingly.
- <12> Self-cooling motors do not require the same wiring necessary for motors with cooling fans.

WARNING! *Sudden Movement Hazard. Do not close the wiring for the control circuit unless the multifunction input terminal parameters are properly set. Improper sequencing of run/stop circuitry could result in death or serious injury from moving equipment.*

WARNING! *Sudden Movement Hazard. Ensure start/stop and safety circuits are wired properly and in the correct state before energizing the drive. Failure to comply could result in death or serious injury from moving equipment. When programmed for 3-Wire control, a momentary closure on terminal S1 may cause the drive to start.*

WARNING! *Sudden Movement Hazard. When using a 3-Wire sequence, set the drive to 3-Wire sequence prior to wiring the control terminals and set parameter b1-17 to 0 so the drive will not accept a Run command at power up (default). If the drive is wired for a 3-Wire sequence but set up for a 2-Wire sequence (default), and parameter b1-17 is set to 1 so the drive accepts a Run command at power up, the motor will rotate in reverse direction at drive power up and may cause injury.*

WARNING! *Sudden Movement Hazard. Confirm the drive I/O signals and external sequence before executing the application preset function. Executing the application preset function or setting A1-03 ≠ 0 will change the drive I/O terminal functions and may cause unexpected equipment operation. Failure to comply may cause death or serious injury.*

NOTICE: *When using the automatic fault restart function with wiring designed to shut off the power supply upon drive fault, make sure the drive does not trigger a fault output during fault restart (L5-02 = 0, default). Failure to comply will prevent the automatic fault restart function from working properly.*

3.2 Main Circuit Connection Diagram

Refer to diagrams in this section when wiring the main circuit of the drive. Connections may vary based on drive capacity. The DC power supply for the main circuit also provides power to the control circuit.

NOTICE: Do not use the negative DC bus terminal “-” as a ground terminal. This terminal is at high DC voltage potential. Improper wiring connections could damage the drive.

- ◆ **Three-Phase 200 V Class Models 2A0004 to 2A0081**
- Three-Phase 400 V Class Models 4A0002 to 4A0044**
- Three-Phase 600 V Class Models 5A0003 to 5A0032**

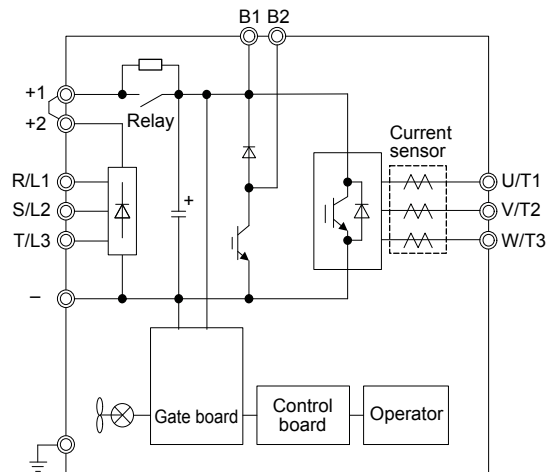

Figure 3.2 Connecting Main Circuit Terminals

- ◆ **Three-Phase 200 V Class Models 2A0110, 2A0138**
- Three-Phase 400 V Class Models 4A0058, 4A0072**
- Three-Phase 600 V Class Models 5A0041, 5A0052**

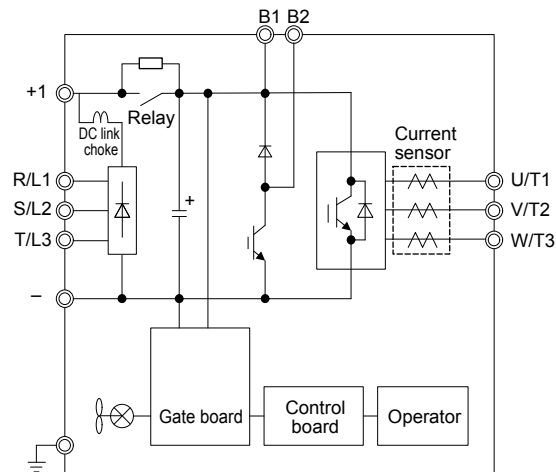

Figure 3.3 Connecting Main Circuit Terminals

3.2 Main Circuit Connection Diagram

- ◆ **Three-Phase 200 V Class Models 2A0169 to 2A0211**
- Three-Phase 400 V Class Models 4A0088 to 4A0139**
- Three-Phase 600 V Class Models 5A0062 to 5A0099**

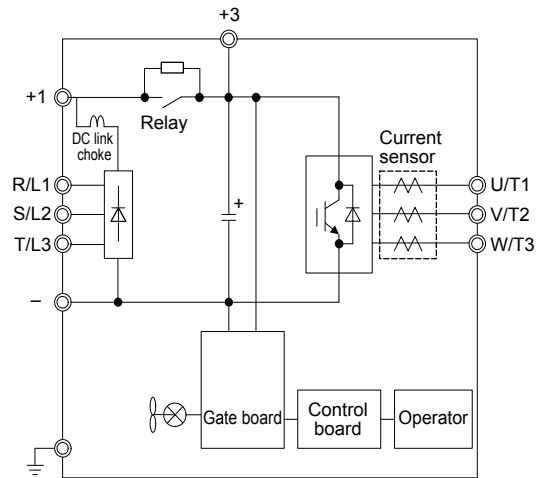

Figure 3.4 Connecting Main Circuit Terminals

- ◆ **Three-Phase 200 V Class Models 2A0250 to 2A0415**
- Three-Phase 400 V Class Models 4A0165 to 4A0675**
- Three-Phase 600 V Class Models 5A0125 to 5A0242**

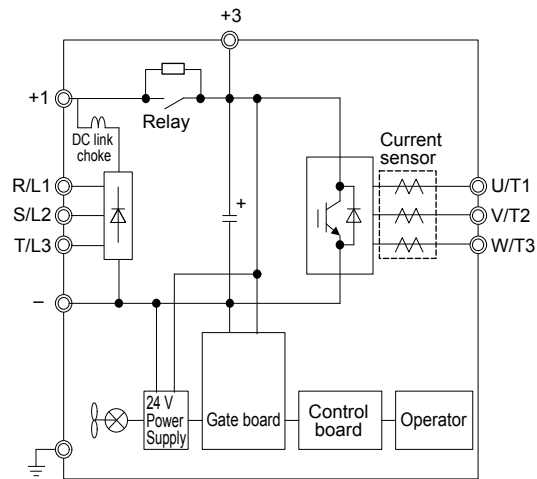

Figure 3.5 Connecting Main Circuit Terminals

3.3 Terminal Cover

Follow the procedure below to remove the terminal cover for wiring and to reattach the terminal cover after wiring is complete.

◆ Models 2A0004 to 2A0081, 4A0002 to 4A0044, 5A0003 to 5A0032 (IP20/NEMA Type 1 Enclosure)

■ Removing the Terminal Cover

1. Loosen the terminal cover screw using a #2 Phillips screwdriver. Screw sizes vary by drive model.

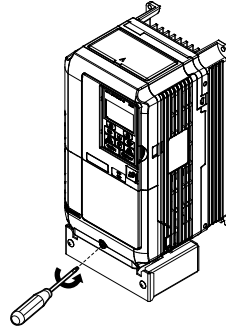

Figure 3.6 Removing the Terminal Cover on an IP20/NEMA Type 1 Enclosure Drive

2. Push in on the tab located on the bottom of the terminal cover and gently pull forward to remove the terminal cover.

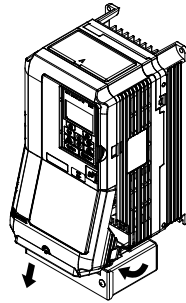

Figure 3.7 Removing the Terminal Cover on an IP20/NEMA Type 1 Enclosure Drive

■ Reattaching the Terminal Cover

Power lines and signal wiring should pass through the opening provided. *Refer to [Wiring the Main Circuit Terminal on page 58](#) and [Wiring the Control Circuit Terminal on page 63](#) for details on wiring.*

Reattach the terminal cover after completing the wiring to the drive and other devices.

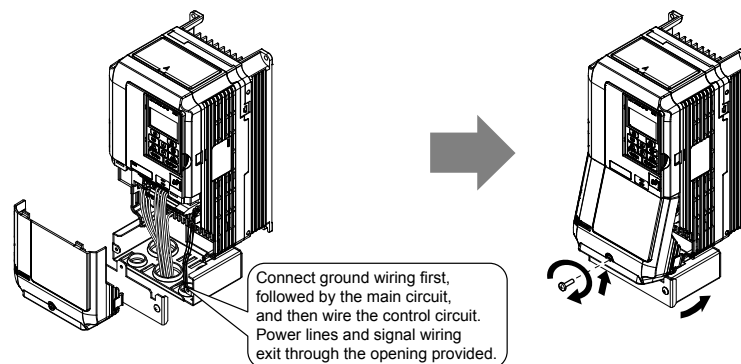

Figure 3.8 Reattaching the Terminal Cover on an IP20/NEMA Type 1 Enclosure Drive

◆ Models 2A0110 to 2A0250, 4A0208 to 4A0675, and 5A0125 to 5A0242 (IP00/Open Type Enclosure)

■ Removing the Terminal Cover

1. Loosen the screws on the terminal cover, then pull down on the cover.

Note: The terminal cover and the number of terminal cover screws differ depending on the drive model.

CAUTION! Do not completely remove the cover screws, just loosen them. If the cover screws are removed completely, the terminal cover may fall off causing an injury.

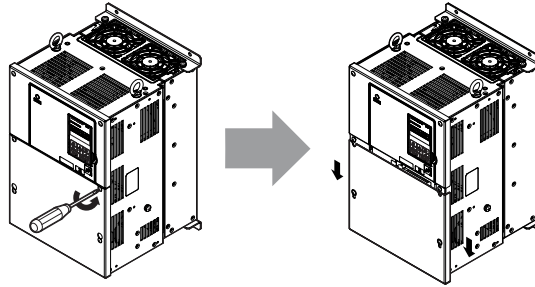

Figure 3.9 Removing the Terminal Cover on an IP00/Open Type Enclosure Drive

2. Pull forward on the terminal cover to free it from the drive.

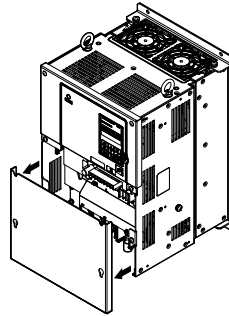

Figure 3.10 Removing the Terminal Cover on an IP00/Open Type Enclosure Drive

■ Reattaching the Terminal Cover

After wiring the terminal board and other devices, double-check connections and reattach the terminal cover. *Refer to Wiring the Main Circuit Terminal on page 58 and Wiring the Control Circuit Terminal on page 63 for details on wiring.*

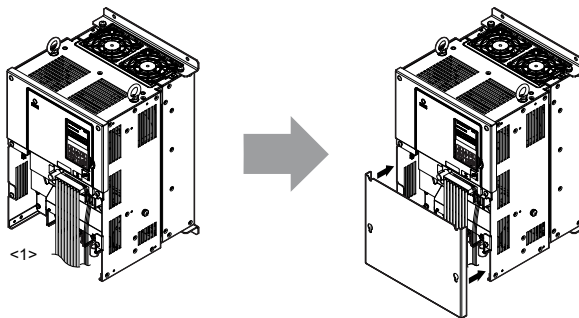

Figure 3.11 Reattaching the Terminal Cover on an IP00/Open Type Enclosure Drive

<1> Connect the ground wiring first, then the main circuit wiring, and finally the control circuit wiring.

3.4 Digital Operator and Front Cover

Detach the digital operator from the drive for remote operation or when opening the front cover to install an option card.

NOTICE: Be sure to remove the digital operator prior to opening or reattaching the front cover. Leaving the digital operator plugged into the drive when removing the front cover can result in erroneous operation caused by a poor connection. Firmly fasten the front cover back into place before reattaching the digital operator.

◆ Removing/Reattaching the Digital Operator

■ Removing the Digital Operator

While pressing on the tab located on the right side of the digital operator, pull the digital operator forward to remove it from the drive.

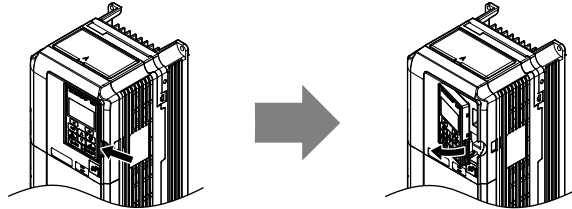

Figure 3.12 Removing the Digital Operator

■ Reattaching the Digital Operator

Insert the digital operator into the opening in the top cover while aligning it with the notches on the left side of the opening. Next, press gently on the right side of the operator until it clicks into place.

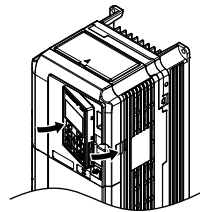

Figure 3.13 Reattaching the Digital Operator

◆ Removing/Reattaching the Front Cover

■ Removing the Front Cover

Models 2A0004 to 2A0081, 4A0002 to 4A0044, and 5A0003 to 5A0032

After removing the terminal cover and the digital operator, loosen the screw that affixes the front cover (models 2A0056, 4A0038, 5A0022, and 5A0027 do not use a screw to affix the front cover). Pinch in on the tabs found on each side of the front cover, then pull forward to remove it from the drive.

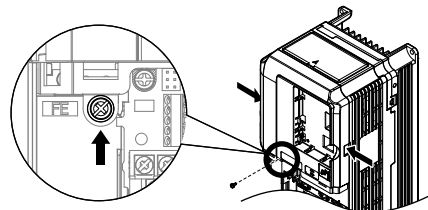

Figure 3.14 Remove the Front Cover (2A0004 to 2A0081, 4A0002 to 4A0044, and 5A0003 to 5A0032)

Models 2A0110 to 2A0415 and 4A0058 to 4A0675

1. Remove the terminal cover and the digital operator.
2. Loosen the installation screw on the front cover.
3. Use a straight-edge screwdriver to loosen the hooks on each side of the cover that hold it in place.

3.4 Digital Operator and Front Cover

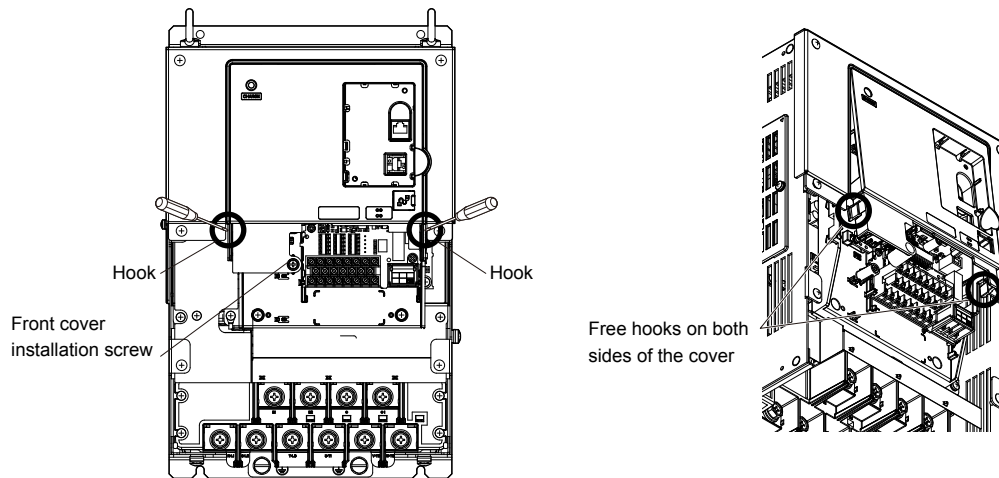

Figure 3.15 Remove the Front Cover (2A0010 to 2A0415 and 4A0058 to 4A0675)

4. Unhook the left side of the front cover then swing the left side towards you as shown in [Figure 3.16](#) until the cover comes off.

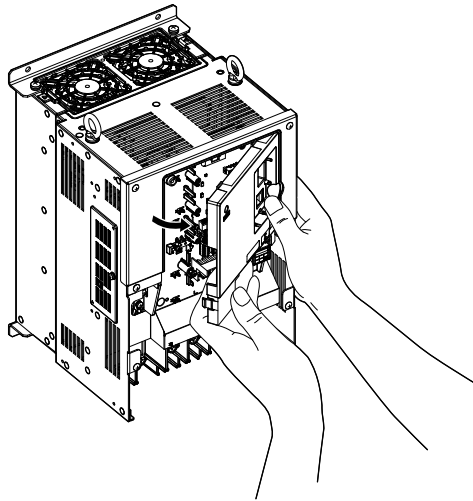

Figure 3.16 Remove the Front Cover (2A0010 to 2A0415 and 4A0058 to 4A0675)

■ Reattaching the Front Cover

Models 2A0004 to 2A0081, 4A0002 to 4A0044, and 5A0003 to 5A0032

Reverse the instructions given in *Remove the Front Cover (2A0004 to 2A0081, 4A0002 to 4A0044, and 5A0003 to 5A0032)* on page 45 to reattach the front cover. Pinch inwards on the hooks found on each side of the front cover while guiding it back into the drive. Make sure it clicks firmly into place.

Models 2A0110 to 2A0415 and 4A0058 to 4A0675

1. Slide the front cover so the hooks on the top connect to the drive.

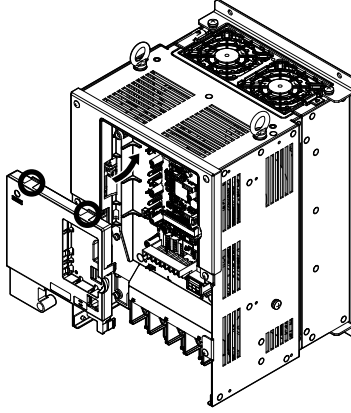

Figure 3.17 Reattach the Front Cover (2A0110 to 2A0415 and 4A0058 to 4A0675)

2. After connecting the hooks to the drive, press firmly on the cover to lock it into place.

3.5 Top Protective Cover

Drive models 2A0004 to 2A0081, 4A0002 to 4A0044, and 5A0003 to 5A0032 are designed to IP20/NEMA Type 1 specifications with a protective cover on the top. Removing this top protective cover or the bottom conduit bracket from an IP20/NEMA Type 1 enclosure drive voids the NEMA Type 1 protection while maintaining IP20 conformity.

◆ Removing the Top Protective Cover

Insert the tip of a straight-edge screwdriver into the small opening located on the front edge of the top protective cover. Gently apply pressure as shown in the figure below to free the cover from the drive.

Note: Removing the top protective cover or the bottom conduit bracket from an IP20/NEMA Type 1 enclosure drive voids the NEMA Type 1 protection while maintaining IP20 conformity.

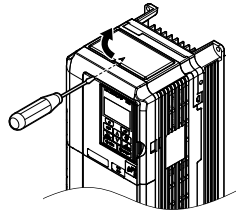

Figure 3.18 Removing the Top Protective Cover

◆ Reattaching the Top Protective Cover

Insert the two small protruding hooks on the rear side of the top protective cover into the provided mounting holes near the back of the drive, then press down on the front side of the top protective cover to fasten the cover into place.

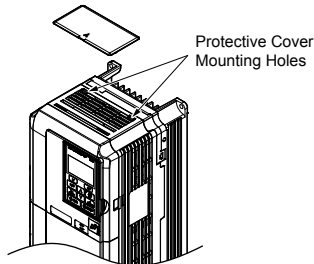

Figure 3.19 Reattaching the Protective Cover

3.6 Main Circuit Wiring

This section describes the functions, specifications, and procedures required to safely and properly wire the main circuit in the drive.

NOTICE: Do not solder the ends of wire connections to the drive. Soldered wiring connections can loosen over time. Improper wiring practices could result in drive malfunction due to loose terminal connections.

NOTICE: Do not switch the drive input to start or stop the motor. Frequently switching the drive on and off shortens the life of the DC bus charge circuit and the DC bus capacitors, and can cause premature drive failures. For the full performance life, refrain from switching the drive on and off more than once every 30 minutes.

Refer to [Input Fuse Installation on page 243](#) for details on fuse selection.

◆ Main Circuit Terminal Functions

Table 3.1 Main Circuit Terminal Functions

Terminal		Type			Function	Page
200 V Class	Drive Model	2A0004 to 2A0081	2A0110 to 2A0138	2A0169 to 2A0415		
400 V Class		4A0002 to 4A0044	4A0058, 4A0072	4A0088 to 4A0675		
600 V Class		5A0003 to 5A0032	5A0041 to 5A0052	5A0062 to 5A0242		
R/L1	Main circuit power supply input				Connects line power to the drive	39
S/L2						
T/L3						
U/T1	Drive output				Connects to the motor	39
V/T2						
W/T3						
B1	Braking resistor		Not available		Available for connecting a braking resistor or a braking resistor unit option	–
B2						
+2	<ul style="list-style-type: none"> DC link choke connection (+1, +2) (remove the shorting bar between +1 and +2) DC power supply input (+1, –) 	Not available			For connecting: <ul style="list-style-type: none"> the drive to a DC power supply (terminals +1 and – are not EU/CE or UL approved) dynamic braking options a DC link choke 	–
+1		DC power supply input (+1, –)	<ul style="list-style-type: none"> DC power supply input (+1, –) Braking unit connection (+3, –) 			
–						
+3	Not available					
	For 200 V class: 100 Ω or less For 400 V class: 10 Ω or less For 600 V class: 10 Ω or less				Grounding terminal	58

Note: Use terminals B1 and – when installing a CDBR-type braking unit on drives with built-in braking transistors (Models 2A0004 to 2A0138, 4A0002 to 4A0072, and 5A0003 to 5A0052).

◆ Protecting Main Circuit Terminals

■ Insulation Caps or Sleeves

Use insulation caps or sleeves when wiring the drive with crimp terminals. Take particular care to ensure that the wiring does not touch nearby terminals or the surrounding case.

■ Insulation Barrier

Insulation barriers are packaged with drive models 4A0414 through 4A0675 to provide added protection between terminals. Yaskawa recommends using the provided insulation barriers to ensure proper wiring. Refer to [Figure 3.20](#) for instructions on placement of the insulation barriers.

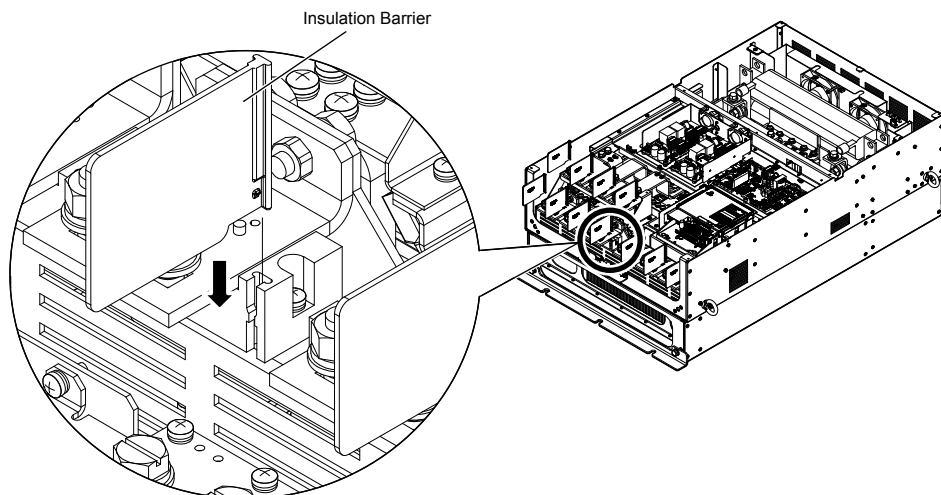

Figure 3.20 Installing Insulation Barriers

◆ Wire Gauges and Tightening Torque

Use the tables in this section to select the appropriate wires and crimp terminals.

Gauges listed in the tables are for use in the United States.

- Note:**
1. Wire gauge recommendations based on drive continuous current ratings (ND) using 75 °C 600 Vac vinyl-sheathed wire assuming ambient temperature within 40 °C and wiring distance less than 100 m.
 2. Terminals +1, +2, +3, –, B1 and B2 are for connecting optional devices such as a DC link choke or braking resistor. Do not connect other nonspecific devices to these terminals.

- Consider the amount of voltage drop when selecting wire gauges. Increase the wire gauge when the voltage drop is greater than 2% of motor rated voltage. Ensure the wire gauge is suitable for the terminal block. Use the following formula to calculate the amount of voltage drop:

$$\text{Line drop voltage (V)} = \sqrt{3} \times \text{wire resistance } (\Omega/\text{km}) \times \text{wire length (m)} \times \text{current (A)} \times 10^{-3}$$

- Refer to instruction manual TOBP C720600 00 for braking transistor option or braking resistor option wire gauges.
- Use terminals +1 and – when connecting a regenerative converter or a regen unit.

NOTICE: Do not connect a braking resistor to terminals +1 or –. Failure to comply may cause damage to the drive circuitry.

- Use terminals B1 and – when installing a CDBR-type braking unit on drives with built-in braking transistors (models 2A0004 to 2A0138, 4A0002 to 4A0072, and 5A0003 to 5A0052).

NOTICE: Do not connect a braking resistor to terminals +1 or –. Failure to comply may cause damage to the drive circuitry.

- **Refer to UL Standards Compliance on page 239** for information on UL compliance.

Yaskawa recommends using closed-loop crimp terminals on all drive models. UL/cUL approval requires the use of closed-loop crimp terminals when wiring the drive main circuit terminals on models 2A0110 to 2A0415 and 4A0058 to 4A0675. Use only the tools recommended by the terminal manufacturer for crimping. **Refer to Closed-Loop Crimp Terminal Size on page 239** for closed-loop crimp terminal recommendations.

The wire gauges listed in the following tables are Yaskawa recommendations. Refer to local codes for proper wire gauge selections.

■ Three-Phase 200 V Class

Table 3.2 Wire Gauge and Torque Specifications (Three-Phase 200 V Class)

Drive Model	Terminal	Recomm. Gauge AWG, kcmil	Wire Range AWG, kcmil	Screw Size	Tightening Torque N·m (lb.in.)
2A0004 2A0006 2A0008 2A0010	R/L1, S/L2, T/L3	14	14 to 10	M4	1.2 to 1.5 (10.6 to 13.3)
	U/T1, V/T2, W/T3	14	14 to 10		
	–, +1, +2	–	14 to 10		
	B1, B2	–	14 to 10		
	⊕	10 </>	14 to 10		
2A0012	R/L1, S/L2, T/L3	12	14 to 10	M4	1.2 to 1.5 (10.6 to 13.3)
	U/T1, V/T2, W/T3	14	14 to 10		
	–, +1, +2	–	14 to 10		
	B1, B2	–	14 to 10		
	⊕	10 </>	14 to 10		
2A0018	R/L1, S/L2, T/L3	10	12 to 10	M4	1.2 to 1.5 (10.6 to 13.3)
	U/T1, V/T2, W/T3	10	14 to 10		
	–, +1, +2	–	14 to 10		
	B1, B2	–	14 to 10		
	⊕	10 </>	14 to 10		
2A0021	R/L1, S/L2, T/L3	10	12 to 10	M4	1.2 to 1.5 (10.6 to 13.3)
	U/T1, V/T2, W/T3	10	12 to 10		
	–, +1, +2	–	12 to 10		
	B1, B2	–	14 to 10		
	⊕	10 </>	12 to 10		

3.6 Main Circuit Wiring

Drive Model	Terminal	Recomm. Gauge AWG, kcmil	Wire Range AWG, kcmil	Screw Size	Tightening Torque N·m (lb.in.)
2A0030	R/L1, S/L2, T/L3	8	10 to 6	M4	2.1 to 2.3 (18.4 to 20.4)
	U/T1, V/T2, W/T3	8	10 to 6		
	-, +1, +2	-	10 to 6		
	B1, B2	-	14 to 10		
	⊕	8 <?>	10 to 8	M5	2 to 2.5 (17.7 to 22.1)
2A0040	R/L1, S/L2, T/L3	6	8 to 6	M4	2.1 to 2.3 (18.4 to 20.4)
	U/T1, V/T2, W/T3	8	8 to 6		
	-, +1, +2	-	6		
	B1, B2	-	12 to 10		
	⊕	8 <?>	10 to 8	M5	2 to 2.5 (17.7 to 22.1)
2A0056	R/L1, S/L2, T/L3	4	6 to 4	M6	5.4 to 6.0 (47.8 to 53.1)
	U/T1, V/T2, W/T3	4	6 to 4		
	-, +1, +2	-	6 to 4		
	B1, B2	-	10 to 6	M5	2.7 to 3.0 (23.9 to 26.6)
	⊕	6	8 to 6	M6	4 to 6 (35.4 to 53.1)
2A0069	R/L1, S/L2, T/L3	3	4 to 3	M8	9.9 to 11.0 (87.6 to 97.4)
	U/T1, V/T2, W/T3	3	4 to 3		
	-, +1, +2	-	4 to 3		
	B1, B2	-	8 to 6	M5	2.7 to 3.0 (23.9 to 26.6)
	⊕	6	6 to 4	M6	4 to 6 (35.4 to 53.1)
2A0081	R/L1, S/L2, T/L3	2	3 to 2	M8	9.9 to 11.0 (87.6 to 97.4)
	U/T1, V/T2, W/T3	2	3 to 2		
	-, +1, +2	-	3 to 2		
	B1, B2	-	6	M5	2.7 to 3.0 (23.9 to 26.6)
	⊕	6	6 to 4	M6	4 to 6 (35.4 to 53.1)
2A0110 <?>	R/L1, S/L2, T/L3	1/0	3 to 1/0	M8	9 to 11 (79.7 to 97.4)
	U/T1, V/T2, W/T3	1/0	3 to 1/0		
	-, +1	-	2 to 1/0		
	B1, B2	-	6 to 1/0		
	⊕	6	6 to 4		
2A0138 <?>	R/L1, S/L2, T/L3	2/0	1 to 2/0	M10	18 to 23 (159 to 204)
	U/T1, V/T2, W/T3	2/0	1 to 2/0		
	-, +1	-	1/0 to 3/0		
	B1, B2	-	4 to 2/0		
	⊕	4	4	M8	9 to 11 (79.7 to 97.4)
2A0169 <?>	R/L1, S/L2, T/L3	4/0	2/0 to 4/0	M10	18 to 23 (159 to 204)
	U/T1, V/T2, W/T3	4/0	3/0 to 4/0		
	-, +1	-	1 to 4/0		
	+3	-	1/0 to 4/0		
	⊕	4	4 to 2		
2A0211 <?>	R/L1, S/L2, T/L3	1/0 × 2P	1/0 to 2/0	M10	18 to 23 (159 to 204)
	U/T1, V/T2, W/T3	1/0 × 2P	1/0 to 2/0		
	-, +1	-	1 to 4/0		
	+3	-	1/0 to 4/0		
	⊕	4	4 to 1/0		

Drive Model	Terminal	Recomm. Gauge AWG, kcmil	Wire Range AWG, kcmil	Screw Size	Tightening Torque N·m (lb.in.)
2A0250 <2>	R/L1, S/L2, T/L3	3/0 × 2P	3/0 to 300	M12	32 to 40 (283 to 354)
	U/T1, V/T2, W/T3	3/0 × 2P	3/0 to 300		
	-, +1	-	3/0 to 300		
	+3	-	2 to 300	M10	18 to 23 (159 to 204)
	⊕	3	3 to 300	M12	32 to 40 (283 to 354)
2A0312 <2>	R/L1, S/L2, T/L3	4/0 × 2P	3/0 to 300	M12	32 to 40 (283 to 354)
	U/T1, V/T2, W/T3	3/0 × 2P	3/0 to 300		
	-, +1	-	3/0 to 300		
	+3	-	3/0 to 300	M10	18 to 23 (159 to 204)
	⊕	2	2 to 300	M12	32 to 40 (283 to 354)
2A0360 <2>	R/L1, S/L2, T/L3	250 × 2P	4/0 to 600	M12	32 to 40 (283 to 354)
	U/T1, V/T2, W/T3	4/0 × 2P	4/0 to 600		
	-, +1	-	250 to 600		
	+3	-	3/0 to 600	M10	18 to 23 (159 to 204)
	⊕	1	1 to 350	M12	32 to 40 (283 to 354)
2A0415 <2>	R/L1, S/L2, T/L3	350 × 2P	250 to 600	M12	32 to 40 (283 to 354)
	U/T1, V/T2, W/T3	300 × 2P	300 to 600		
	-, +1	-	300 to 600		
	+3	-	3/0 to 600	M10	18 to 23 (159 to 204)
	⊕	1	1 to 350	M12	32 to 40 (283 to 354)

- <1> When installing an EMC filter, additional measures must be taken to comply with IEC61800-5-1. *Refer to EMC Filter Installation on page 234* for details.
- <2> Drive models 2A0110 to 2A0415 require the use of UL-Listed closed-loop crimp terminals for UL/cUL compliance. Use only the tools recommended by the terminal manufacturer for crimping.

■ Three-Phase 400 V Class

Table 3.3 Wire Gauge and Torque Specifications (Three-Phase 400 V Class)

Drive Model	Terminal	Recomm. Gauge AWG, kcmil	Wire Range AWG, kcmil	Screw Size	Tightening Torque N·m (lb.in.)
4A0002 4A0004	R/L1, S/L2, T/L3	14	14 to 10	M4	1.2 to 1.5 (10.6 to 13.3)
	U/T1, V/T2, W/T3	14	14 to 10		
	-, +1, +2	-	14 to 10		
	B1, B2	-	14 to 10		
	⊕	12	14 to 12		
4A0005 4A0007 4A0009	R/L1, S/L2, T/L3	14	14 to 10	M4	1.2 to 1.5 (10.6 to 13.3)
	U/T1, V/T2, W/T3	14	14 to 10		
	-, +1, +2	-	14 to 10		
	B1, B2	-	14 to 10		
	⊕	10	14 to 10		
4A0011	R/L1, S/L2, T/L3	12	14 to 10	M4	1.2 to 1.5 (10.6 to 13.3)
	U/T1, V/T2, W/T3	14	14 to 10		
	-, +1, +2	-	14 to 10		
	B1, B2	-	14 to 10		
	⊕	10	14 to 10		

3.6 Main Circuit Wiring

Drive Model	Terminal	Recomm. Gauge AWG, kcmil	Wire Range AWG, kcmil	Screw Size	Tightening Torque N·m (lb.in.)
4A0018	R/L1, S/L2, T/L3	10	12 to 6	M4	2.1 to 2.3 (18.4 to 20.4)
	U/T1, V/T2, W/T3	10	12 to 6		
	-, +1, +2	-	12 to 6		
	B1, B2	-	12 to 10		
	⊕	10	14 to 10	M5	2 to 2.5 (17.7 to 22.1)
4A0023	R/L1, S/L2, T/L3	10	10 to 6	M4	2.1 to 2.3 (18.4 to 20.4)
	U/T1, V/T2, W/T3	10	10 to 6		
	-, +1, +2	-	12 to 6		
	B1, B2	-	12 to 10		
	⊕	10	12 to 10	M5	2 to 2.5 (17.7 to 22.1)
4A0031	R/L1, S/L2, T/L3	8	8 to 6	M5	2.7 to 3.0 (23.9 to 26.6)
	U/T1, V/T2, W/T3	8	10 to 6		
	-, +1, +2	-	10 to 6		
	B1, B2	-	10 to 8	M5	4 to 6 (35.4 to 53.1)
	⊕	8	10 to 8	M6	
4A0038	R/L1, S/L2, T/L3	6	8 to 6	M5	2.7 to 3.0 (23.9 to 26.6)
	U/T1, V/T2, W/T3	8	8 to 6		
	-, +1, +2	-	6		
	B1, B2	-	10 to 8	M5	4 to 6 (35.4 to 53.1)
	⊕	6	10 to 6	M6	
4A0044	R/L1, S/L2, T/L3	6	6 to 4	M6	5.4 to 6.0 (47.8 to 53.1)
	U/T1, V/T2, W/T3	6	6 to 4		
	-, +1, +2	-	6 to 4		
	B1, B2	-	10 to 8	M5	2.7 to 3.0 (23.9 to 26.6)
	⊕	6	8 to 6	M6	4 to 6 (35.4 to 53.1)
4A0058 <>	R/L1, S/L2, T/L3	4	6 to 4	M8	9 to 11 (79.7 to 97.4)
	U/T1, V/T2, W/T3	4	6 to 4		
	-, +1	-	6 to 1		
	B1, B2	-	8 to 4		
	⊕	6	8 to 6		
4A0072 <>	R/L1, S/L2, T/L3	3	4 to 3	M8	9 to 11 (79.7 to 97.4)
	U/T1, V/T2, W/T3	3	4 to 3		
	-, +1	-	4 to 1		
	B1, B2	-	6 to 3		
	⊕	6	6		
4A0088 <>	R/L1, S/L2, T/L3	2	3 to 1/0	M8	9 to 11 (79.7 to 97.4)
	U/T1, V/T2, W/T3	2	3 to 1/0		
	-, +1	-	3 to 1/0		
	+3	-	6 to 1/0		
	⊕	4	6 to 4		
4A0103 <>	R/L1, S/L2, T/L3	1/0	2 to 1/0	M8	9 to 11 (79.7 to 97.4)
	U/T1, V/T2, W/T3	1	2 to 1/0		
	-, +1	-	3 to 1/0		
	+3	-	4 to 1/0		
	⊕	4	6 to 4		

Drive Model	Terminal	Recomm. Gauge AWG, kcmil	Wire Range AWG, kcmil	Screw Size	Tightening Torque N·m (lb.in.)
4A0139 <1>	R/L1, S/L2, T/L3	3/0	1/0 to 4/0	M10	18 to 23 (159 to 204)
	U/T1, V/T2, W/T3	2/0	1/0 to 4/0		
	-, +1	-	1/0 to 4/0		
	+3	-	3 to 4/0		
	⊕	4	4		
4A0165 <1>	R/L1, S/L2, T/L3	4/0	3/0 to 4/0	M10	18 to 23 (159 to 204)
	U/T1, V/T2, W/T3	4/0	3/0 to 4/0		
	-, +1	-	1 to 4/0		
	+3	-	1/0 to 4/0		
	⊕	4	4 to 2		
4A0208 <1>	R/L1, S/L2, T/L3	300	2 to 300	M10	18 to 23 (159 to 204)
	U/T1, V/T2, W/T3	300	2 to 300		
	-, +1	-	1 to 250		
	+3	-	3 to 3/0		
	⊕	4	4 to 300		
4A0250 <1>	R/L1, S/L2, T/L3	400	1 to 600	M10	18 to 23 (159 to 204)
	U/T1, V/T2, W/T3	400	1/0 to 600		
	-, +1	-	3/0 to 600		
	+3	-	1 to 325		
	⊕	2	2 to 350		
4A0296 <1>	R/L1, S/L2, T/L3	500	2/0 to 600	M12	32 to 40 (283 to 354)
	U/T1, V/T2, W/T3	500	2/0 to 600		
	-, +1	-	3/0 to 600	M10	18 to 23 (159 to 204)
	+3	-	1 to 325		
	⊕	2	2 to 350		
4A0362 <1>	R/L1, S/L2, T/L3	4/0 × 2P	3/0 to 600	M12	32 to 40 (283 to 354)
	U/T1, V/T2, W/T3	4/0 × 2P	3/0 to 600		
	-, +1	-	4/0 to 600	M10	18 to 23 (159 to 204)
	+3	-	3/0 to 600		
	⊕	1	1 to 350		
4A0414 <1> <2>	R/L1, S/L2, T/L3	300 × 2P	4/0 to 300	M12	32 to 40 (283 to 354)
	U/T1, V/T2, W/T3	300 × 2P	4/0 to 300		
	-, +1	-	3/0 to 300		
	+3	-	3/0 to 300		
	⊕	1	1 to 3/0		
4A0515 <1> <2>	R/L1, S/L2, T/L3	3/0 × 4P	3/0 to 300	M12	32 to 40 (283 to 354)
	U/T1, V/T2, W/T3	4/0 × 4P	3/0 to 300		
	-, +1	-	1/0 to 300		
	+3	-	1/0 to 300		
	⊕	1/0	1/0 to 300		
4A0675 <1> <2>	R/L1, S/L2, T/L3	300 × 4P	4/0 to 300	M12	32 to 40 (283 to 354)
	U/T1, V/T2, W/T3	300 × 4P	4/0 to 300		
	-, +1	-	1/0 to 300		
	+3	-	1/0 to 300		
	⊕	2/0	2/0 to 300		

<1> Drive models 4A0058 to 4A0675 require the use of UL-Listed closed-loop crimp terminals for UL/cUL compliance. Use only the tools recommended by the terminal manufacturer for crimping.

<2> When installing an EMC filter, additional measures must be taken to comply with IEC61800-5-1. *Refer to EMC Filter Installation on page 234* for details.

3.6 Main Circuit Wiring

■ Three-Phase 600 V Class

Table 3.4 Wire Gauge and Torque Specifications (Three-Phase 600 V Class)

Drive Model	Terminal	Recomm. Gauge AWG, kcmil	Wire Range AWG, kcmil	Screw Size	Tightening Torque N·m (lb.in.)
5A0003 5A0004 5A0006	R/L1, S/L2, T/L3	14	14 to 10	M4	1.2 to 1.5 (10.6 to 13.3)
	U/T1, V/T2, W/T3	14	14 to 10		
	-, +1, +2	-	14 to 10		
	B1, B2	-	14 to 10		
	⊕	10	14 to 10		
5A0009	R/L1, S/L2, T/L3	14	14 to 10	M4	1.2 to 1.5 (10.6 to 13.3)
	U/T1, V/T2, W/T3	14	14 to 10		
	-, +1, +2	-	14 to 10		
	B1, B2	-	14 to 10		
	⊕	10	12 to 10		
5A0011	R/L1, S/L2, T/L3	10	14 to 6	M4	1.2 to 1.5 (10.6 to 13.3)
	U/T1, V/T2, W/T3	14	14 to 6		
	-, +1, +2	-	14 to 6		
	B1, B2	-	14 to 10		
	⊕	8	12 to 8	M5	2 to 2.5 (17.7 to 22.1)
5A0017	R/L1, S/L2, T/L3	10	10 to 6	M5	2 to 2.5 (17.7 to 22.1)
	U/T1, V/T2, W/T3	10	10 to 6		
	-, +1, +2	-	10 to 6		
	B1, B2	-	10 to 8		
	⊕	8	12 to 8	M6	4 to 6 (35.4 to 53.1)
5A0022	R/L1, S/L2, T/L3	8	10 to 6	M5	2 to 2.5 (17.7 to 22.1)
	U/T1, V/T2, W/T3	10	10 to 6		
	-, +1, +2	-	10 to 6		
	B1, B2	-	10 to 8		
	⊕	8	10 to 6	M6	4 to 6 (35.4 to 53.1)
5A0027 5A0032	R/L1, S/L2, T/L3	6	6 to 4	M6	4 to 6 (35.4 to 53.1)
	U/T1, V/T2, W/T3	6	6 to 4		
	-, +1, +2	-	6 to 4		
	B1, B2	-	10 to 8	M5	2 to 2.5 (17.7 to 22.1)
	⊕	6	10 to 6	M6	4 to 6 (35.4 to 53.1)
5A0041	R/L1, S/L2, T/L3	6	10 to 3	M8	9 to 11 (79.7 to 97.4)
	U/T1, V/T2, W/T3	6	10 to 3		
	-, +1	-	6 to 1		
	B1, B2	-	12 to 3		
	⊕	6	6		
5A0052	R/L1, S/L2, T/L3	4	10 to 3	M8	9 to 11 (79.7 to 97.4)
	U/T1, V/T2, W/T3	6	10 to 3		
	-, +1	-	6 to 1		
	B1, B2	-	8 to 3		
	⊕	6	6		
5A0062	R/L1, S/L2, T/L3	4	10 to 4/0	M10	18 to 23 (159 to 204)
	U/T1, V/T2, W/T3	4	10 to 4/0		
	-, +1	-	4 to 4/0		
	+3	-	6 to 4/0		
	⊕	4	4		

Drive Model	Terminal	Recomm. Gauge AWG, kcmil	Wire Range AWG, kcmil	Screw Size	Tightening Torque N·m (lb.in.)
5A0077	R/L1, S/L2, T/L3	3	10 to 4/0	M10	18 to 23 (159 to 204)
	U/T1, V/T2, W/T3	3	10 to 4/0		
	-, +1	-	3 to 4/0		
	+3	-	6 to 4/0		
	⊕	4	4		
5A0099	R/L1, S/L2, T/L3	1/0	10 to 4/0	M10	18 to 23 (159 to 204)
	U/T1, V/T2, W/T3	1	10 to 4/0		
	-, +1	-	2 to 4/0		
	+3	-	4 to 4/0		
	⊕	4	4		
5A0125	R/L1, S/L2, T/L3	2/0	1 to 300	M10	18 to 23 (159 to 204)
	U/T1, V/T2, W/T3	2/0	1 to 300		
	-, +1	-	2/0 to 3/0		
	+3	-	1 to 1/0		
	⊕	3	4 to 300		
5A0145	R/L1, S/L2, T/L3	3/0	2/0 to 300	M10	18 to 23 (159 to 204)
	U/T1, V/T2, W/T3	3/0	2/0 to 300		
	-, +1	-	3/0 to 4/0		
	+3	-	1/0 to 2/0		
	⊕	3	4 to 300		
5A0192	R/L1, S/L2, T/L3	300	2/0 to 600	M12	32 to 40 (283 to 354)
	U/T1, V/T2, W/T3	250	2/0 to 600		
	-, +1	-	2/0 to 400	M10	18 to 23 (159 to 204)
	+3	-	2/0 to 250		
	⊕	1	1 to 350		
5A0242	R/L1, S/L2, T/L3	400	2/0 to 600	M12	32 to 40 (283 to 354)
	U/T1, V/T2, W/T3	350	2/0 to 600		
	-, +1	-	2/0 to 500		
	+3	-	250 to 300	M10	18 to 23 (159 to 204)
	⊕	1	1 to 350	M12	32 to 40 (283 to 354)

◆ Main Circuit Terminal and Motor Wiring

This section outlines the various steps, precautions, and checkpoints for wiring the main circuit terminals and motor terminals.

WARNING! *Electrical Shock Hazard. Do not connect the AC power line to the output terminals of the drive. Failure to comply could result in death or serious injury by fire as a result of drive damage from line voltage application to output terminals.*

NOTICE: *When connecting the motor to the drive output terminals U/T1, V/T2, and W/T3, the phase order for the drive and motor should match. Failure to comply with proper wiring practices may cause the motor to run in reverse if the phase order is backward.*

NOTICE: *Do not connect phase-advancing capacitors or LC/RC noise filters to the output circuits. Failure to comply could result in damage to the drive, phase-advancing capacitors, LC/RC noise filters or ground fault circuit interrupters.*

■ Cable Length Between Drive and Motor

Voltage drop along the motor cable may cause reduced motor torque when the wiring between the drive and the motor is too long, especially at low frequency output. This can also be a problem when motors are connected in parallel with a fairly long motor cable. Drive output current will increase as the leakage current from the cable increases. An increase in leakage current may trigger an overcurrent situation and weaken the accuracy of the current detection.

Adjust the drive carrier frequency according to [Table 3.5](#). If the motor wiring distance exceeds 100 m because of the system configuration, reduce the ground currents. [Refer to C6-02: Carrier Frequency Selection on page 94.](#)

3.6 Main Circuit Wiring

Table 3.5 Cable Length Between Drive and Motor

Cable Length	50 m or less	100 m or less	Greater than 100 m
Carrier Frequency	15 kHz or less	5 kHz or less	2 kHz or less

Note: When setting carrier frequency for drives running multiple motors, calculate cable length as the total wiring distance to all connected motors.

Ground Wiring

Follow the precautions below when wiring the ground for one drive or a series of drives.

WARNING! Electrical Shock Hazard. Make sure the protective earthing conductor complies with technical standards and local safety regulations. Because the leakage current exceeds 3.5 mA in models 4A0414 and larger, IEC 61800-5-1 states that either the power supply must be automatically disconnected in case of discontinuity of the protective earthing conductor or a protective earthing conductor with a cross-section of at least 10 mm² (Cu) or 16 mm² (Al) must be used. Failure to comply may result in death or serious injury.

WARNING! Electrical Shock Hazard. Always use a ground wire that complies with technical standards on electrical equipment and minimize the length of the ground wire. Improper equipment grounding may cause dangerous electrical potentials on equipment chassis, which could result in death or serious injury.

WARNING! Electrical Shock Hazard. Be sure to ground the drive ground terminal (200 V class: ground to 100 Ω or less; 400 V class: ground to 10 Ω or less; 600 V class: ground to 10 Ω or less). Improper equipment grounding could result in death or serious injury by contacting ungrounded electrical equipment.

NOTICE: Do not share the ground wire with other devices such as welding machines or large-current electrical equipment. Improper equipment grounding could result in drive or equipment malfunction due to electrical interference.

NOTICE: When using more than one drive, ground multiple drives according to instructions. Improper equipment grounding could result in abnormal operation of drive or equipment.

Refer to [Figure 3.21](#) when using multiple drives. Do not loop the ground wire.

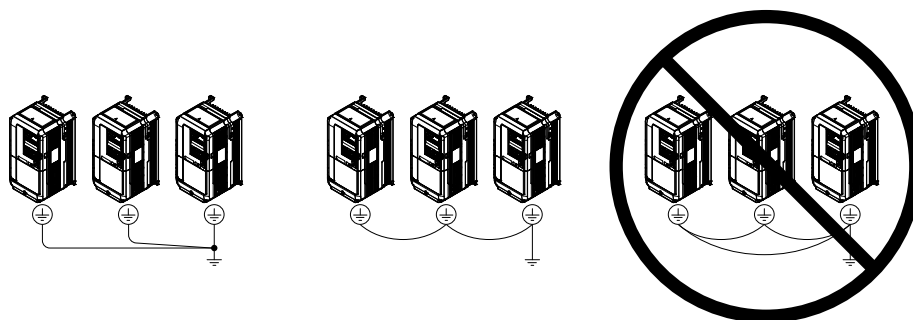

Figure 3.21 Multiple Drive Wiring

Wiring the Main Circuit Terminal

WARNING! Electrical Shock Hazard. Shut off the power supply to the drive before wiring the main circuit terminals. Failure to comply may result in death or serious injury.

Wire the main circuit terminals after the terminal board has been properly grounded.

Models 2A0004 to 2A0081, 4A0002 to 4A0044, and 5A0003 to 5A0032 have a cover placed over the DC bus and braking circuit terminals prior to shipment to help prevent miswiring. Use wire cutters to cut away covers as needed for terminals.

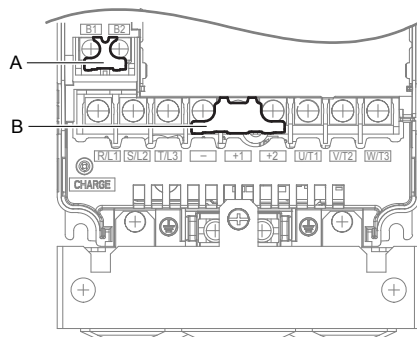

A – Braking circuit protective cover

B – DC bus protective cover

Figure 3.22 Protecting Cover to Prevent Miswiring (Model 5A0011)

■ Main Circuit Connection Diagram

Refer to Main Circuit Connection Diagram on page 41 when wiring terminals on the main power circuit of the drive.

WARNING! *Fire Hazard. The braking resistor connection terminals are B1 and B2. Do not connect braking resistors to any other terminals. Improper wiring connections could cause the braking resistor to overheat and cause death or serious injury by fire. Failure to comply may result in damage to the braking circuit or drive.*

3.7 Control Circuit Wiring

◆ Control Circuit Terminal Block Functions

Drive parameters determine which functions apply to the multi-function digital inputs (S1 to S8), multi-function digital outputs (M1 to M4), multi-function analog inputs (A1 to A3), and multi-function analog monitor output (FM, AM). The default setting is listed next to each terminal in [Figure 3.1](#) on page 39.

WARNING! Sudden Movement Hazard. Always check the operation and wiring of control circuits after being wired. Operating a drive with untested control circuits could result in death or serious injury.

WARNING! Sudden Movement Hazard. Confirm the drive I/O signals and external sequence before starting test run. Setting parameter A1-03 may change the I/O terminal function automatically from the factory setting. Refer to [Application Selection on page 84](#). Failure to comply may result in death or serious injury.

■ Input Terminals

[Table 3.6](#) lists the input terminals on the drive. Text in parenthesis indicates the default setting for each multi-function input.

Table 3.6 Control Circuit Input Terminals

Type	No.	Terminal Name (Function)	Function (Signal Level) Default Setting	Page
Multi-Function Digital Inputs	S1	Multi-function input 1 (Closed: Forward run, Open: Stop)	<ul style="list-style-type: none"> • Photocoupler • 24 Vdc, 8 mA • Refer to Sinking/Sourcing Mode Switch for Digital Inputs on page 65. 	196
	S2	Multi-function input 2 (Closed: Reverse run, Open: Stop)		
	S3	Multi-function input 3 (External fault, N.O.)		
	S4	Multi-function input 4 (Fault reset)		
	S5	Multi-function input 5 (Multi-step speed reference 1)		
	S6	Multi-function input 6 (Multi-step speed reference 2)		
	S7	Multi-function input 7 (Jog reference)		
	S8	Multi-function input 8 (Baseblock command (N.O.))		
	SC	Multi-function input common	Multi-function input common	
	SP	Digital input power supply +24 Vdc	24 Vdc power supply for digital inputs, 150 mA max	65
	SN	Digital input power supply 0 V 24 V transducer power supply 0 V	NOTICE: Do not jumper or short terminals SP and SN. Failure to comply will damage the drive.	65
Analog Inputs / Pulse Train Input	RP	Multi-function pulse train input (Frequency reference)	<ul style="list-style-type: none"> • Input frequency range: 0 to 32 kHz • Signal Duty Cycle: 30 to 70% • High level: 3.5 to 13.2 Vdc, low level: 0.0 to 0.8 Vdc • Input impedance: 3 kΩ 	87 204
	+V	Power supply for analog inputs	10.5 Vdc (max allowable current 20 mA)	86
	24 V	+24 Vdc transducer power supply for customer use	150 mA maximum capacity	–
	A1	Multi-function analog input 1 (Frequency reference bias)	<ul style="list-style-type: none"> • -10 to 10 Vdc, 0 to 10 Vdc (input impedance: 20 kΩ) • 4 to 20 mA, 0 to 20 mA (input impedance: 250 Ω) • Voltage or current input must be selected by jumper S1 and H3-01. 	86 104
	A2	Multi-function analog input 2 (Frequency reference bias)	<ul style="list-style-type: none"> • -10 to 10 Vdc, 0 to 10 Vdc (input impedance: 20 kΩ) • 4 to 20 mA, 0 to 20 mA (input impedance: 250 Ω) • Voltage or current input must be selected by jumper S1 and H3-09. 	86 86 106
	A3	Multi-function analog input 3 (Frequency reference bias)	<ul style="list-style-type: none"> • -10 to 10 Vdc, 0 to 10 Vdc (input impedance: 20 kΩ) • 4 to 20 mA, 0 to 20 mA (input impedance: 250 Ω) • Voltage or current input must be selected by jumper S1 and H3-05. 	86
	AC	Frequency reference common	0 V	86
	E (G)	Ground for shielded lines and option cards	–	–

Output Terminals

Table 3.7 lists the output terminals on the drive. Text in parenthesis indicates the default setting for each multi-function output.

Table 3.7 Control Circuit Output Terminals

Type	No.	Terminal Name (Function)	Function (Signal Level) Default Setting	Page
Fault Relay Output	MA	N.O.	30 Vdc, 10 mA to 1 A; 250 Vac, 10 mA to 1 A Minimum load: 5 Vdc, 10 mA	102
	MB	N.C. output		
	MC	Fault output common		
Multi-Function Digital Output <I>	MD	N.O.	30 Vdc, 10 mA to 1 A; 250 Vac, 10 mA to 1 A Minimum load: 5 Vdc, 10 mA	102
	ME	N.C. Output		
	MF	Common (Speed agree)		
	M1	Multi-function digital output (During run)		
	M2			
	M3	Multi-function digital output (Zero speed)		
M4				
Monitor Output	FM	Analog monitor output 1 (Output frequency)	-10 to +10 Vdc, or 0 to +10 Vdc	202
	AM	Analog monitor output 2 (Output current)		
	AC	Monitor common	0 V	-

<1> Refrain from assigning functions to digital relay outputs that involve frequent switching, as doing so may shorten relay performance life. Switching life is estimated at 200,000 times (assumes 1 A, resistive load).

Connect a suppression diode as shown in Figure 3.23 when driving a reactive load such as a relay coil. Ensure the diode rating is greater than the circuit voltage.

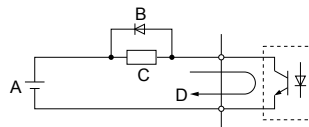

A – External power, 48 V max.
 B – Suppression diode
 C – Coil
 D – 50 mA or less

Figure 3.23 Connecting a Suppression Diode

Serial Communication Terminals

Table 3.8 Control Circuit Terminals: Serial Communications

Type	No.	Signal Name	Function (Signal Level)
MEMOBUS/Modbus Communication <I>	R+	Communications input (+)	MEMOBUS/Modbus communication: Use an RS-422 or RS-485 cable to connect the drive. RS-422/RS-485 MEMOBUS/Modbus communication protocol 115.2 kbps (max.)
	R-	Communications input (-)	
	S+	Communications output (+)	
	S-	Communications output (-)	
	IG	Shield ground	0 V

<1> Enable the termination resistor in the last drive in a MEMOBUS/Modbus network by setting DIP switch S2 to the ON position. Refer to Control I/O Connections on page 65 for more information on the termination resistor.

◆ Terminal Configuration

The control circuit terminals are arranged as shown in [Figure 3.24](#).

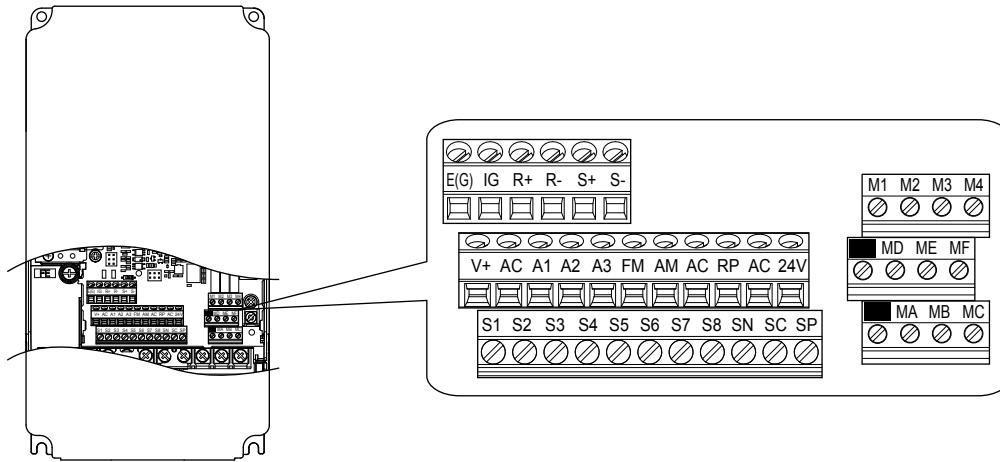

Figure 3.24 Control Circuit Terminal Arrangement

■ Wire Size and Torque Specifications

Select appropriate wire type and gauges from [Table 3.9](#). For simpler and more reliable wiring, use crimp ferrules on the wire ends. Refer to [Table 3.10](#) for ferrule terminal types and sizes.

Table 3.9 Wire Gauges

Terminal	Screw Size	Tightening Torque N•m (lb. in)	Bare Wire Terminal		Ferrule-Type Terminal		Wire Type
			Applicable wire size mm ² (AWG)	Recomm. wire size mm ² (AWG)	Applicable wire size mm ² (AWG)	Recomm. wire size mm ² (AWG)	
S1-S8, SC, SN, SP	M3	0.5 to 0.6 (4.4 to 5.3)	Stranded wire: 0.2 to 1.0 (24 to 16) Solid wire: 0.2 to 1.5 (24 to 16)	0.75 (18)	0.25 to 0.5 (24 to 20)	0.5 (20)	Shielded wire, etc.
RP, V+, A1, A2, A3, AC, 24 V							
MA, MB, MC, MD, ME, MF							
M1-M4							
FM, AM, AC							
R+, R-, S+, S-, IG							

■ Ferrule-Type Wire Terminals

Yaskawa recommends using CRIMPFOX 6, a crimping tool manufactured by PHOENIX CONTACT, to prepare wire ends with insulated sleeves before connecting to the drive. See [Table 3.10](#) for dimensions.

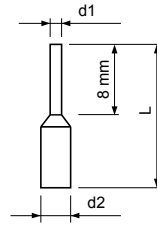

Figure 3.25 Ferrule Dimensions

Table 3.10 Ferrule Terminal Types and Sizes

Size mm ² (AWG)	Type	L (mm)	d1 (mm)	d2 (mm)	Manufacturer
0.25 (24)	AI 0.25-8YE	12.5	0.8	1.8	PHOENIX CONTACT
0.34 (22)	AI 0.34-8TQ	10.5	0.8	1.8	
0.5 (20)	AI 0.5-8WH or AI 0.5-8OG	14	1.1	2.5	

◆ Wiring the Control Circuit Terminal

This section describes the proper procedures and preparations for wiring the control terminals.

WARNING! *Electrical Shock Hazard. Do not remove covers or touch the circuit boards while the power is on. Failure to comply could result in death or serious injury.*

NOTICE: *Separate control circuit wiring from main circuit wiring (terminals R/L1, S/L2, T/L3, B1, B2, U/T1, V/T2, W/T3, -, +1, +2) and other high-power lines. Improper wiring practices could result in drive malfunction due to electrical interference.*

NOTICE: *Separate wiring for digital output terminals MA, MB, MC, MD, ME, MF and M1 to M4 from wiring to other control circuit lines. Improper wiring practices could result in drive or equipment malfunction or nuisance trips.*

NOTICE: *Use a class 2 power supply when connecting to the control terminals. Improper application of peripheral devices could result in drive performance degradation due to improper power supply. Refer to NEC Article 725 Class 1, Class 2, and Class 3 Remote-Control, Signaling, and Power Limited Circuits for requirements concerning class 2 power supplies.*

NOTICE: *Insulate shields with tape or shrink tubing to prevent contact with other signal lines and equipment. Improper wiring practices could result in drive or equipment malfunction due to short circuit.*

NOTICE: *Connect the shield of shielded cable to the appropriate ground terminal. Improper equipment grounding could result in drive or equipment malfunction or nuisance trips.*

Wire the control circuit only after terminals have been properly grounded and main circuit wiring is complete. [Refer to Terminal Board Wiring Guide on page 64](#) for details. Prepare the ends of the control circuit wiring as shown in [Figure 3.28](#). [Refer to Wire Gauges on page 62](#).

NOTICE: *Do not tighten screws beyond the specified tightening torque. Failure to comply may result in erroneous operation, damage to the terminal block, or cause a fire.*

NOTICE: *Use shielded twisted-pair cables as indicated to prevent operating faults. Improper wiring practices could result in drive or equipment malfunction due to electrical interference.*

Connect control wires as shown in [Figure 3.26](#) and [Figure 3.27](#).

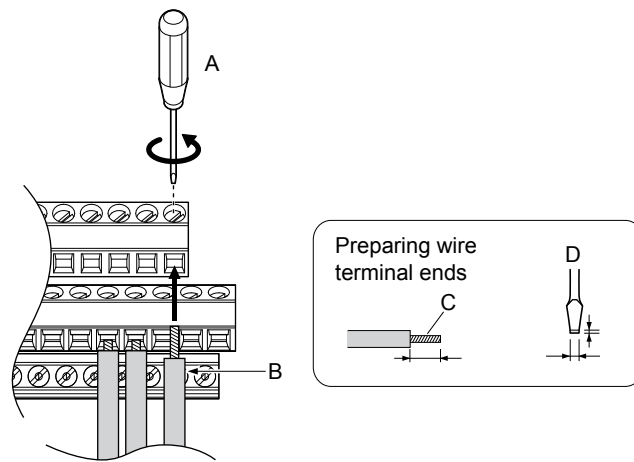

A – Loosen screw to insert wire.
B – Single wire or stranded wire

C – Avoid fraying wire strands when stripping insulation from wire. Strip length 5.5 mm.

D – Blade depth of 0.4 mm or less
 Blade width of 2.5 mm or less

Figure 3.26 Terminal Board Wiring Guide

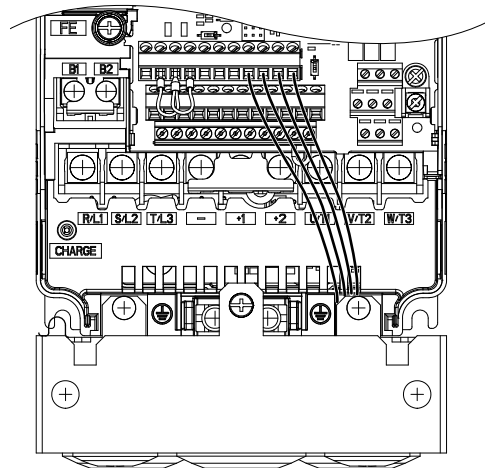
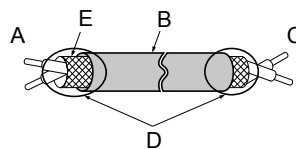

Figure 3.27 Terminal Board Location Inside the Drive

When setting the frequency by analog reference from an external potentiometer, use shielded twisted-pair wires (preparing wire ends as shown in [Figure 3.28](#)) and connect the shield to the ground terminal of the drive.



A – Drive side
B – Insulation
C – Control device side

D – Shield sheath (insulate with tape)
E – Shield

Figure 3.28 Preparing the Ends of Shielded Cables

NOTICE: The analog signal wiring between the drive and the operator station or peripheral equipment should not exceed 50 meters when using an analog signal from a remote source to supply the frequency reference. Failure to comply could result in poor system performance.

3.8 Control I/O Connections

◆ Sinking/Sourcing Mode Switch for Digital Inputs

Use the wire jumper between terminals SC and SP or SC and SN to select between Sink mode, Source mode or external power supply for the digital inputs S1 to S8 as shown in [Table 3.11](#) (Default: Sink mode, internal power supply).

NOTICE: Do not short terminals SP and SN. Failure to comply will damage the drive.

Table 3.11 Digital Input Sink/Source/External Power Supply Selection

Mode	Drive Internal Power Supply (Terminals SN and SP)	External 24 Vdc Power Supply
Sinking Mode (NPN)		
Sourcing Mode (PNP)		

◆ Using the Pulse Train Output

The pulse train output terminal MP can supply power or be used with an external power supply.

NOTICE: Connect peripheral devices in accordance with the specifications. Failure to comply may cause unexpected drive operation, and can damage the drive or connected circuits.

■ Using Power from the Pulse Output Terminal (Source Mode)

The high voltage level of the pulse output terminal depends on the load impedance.

Load Impedance R_L (k Ω)	Output Voltage V_{MP} (V) (insulated)
1.5 k Ω	5 V
4 k Ω	8 V
10 k Ω	10 V

Note: The load resistance needed in order to get a certain high level voltage V_{MP} can be calculated by: $R_L = V_{MP} \cdot 2 / (12 - V_{MP})$

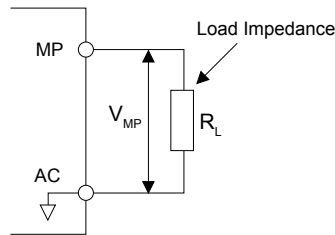

Figure 3.29 Pulse Output Connection Using Internal Voltage Supply

■ Using External Power Supply (Sink Mode)

The high voltage level of the pulse output signal depends on the external voltage applied. The voltage must be between 12 and 15 Vdc. The load resistance must be adjusted so that the current is lower than 16 mA.

External Power Supply (V)	Load Impedance (kΩ)
12 to 15 Vdc ±10%	1.0 kΩ or higher

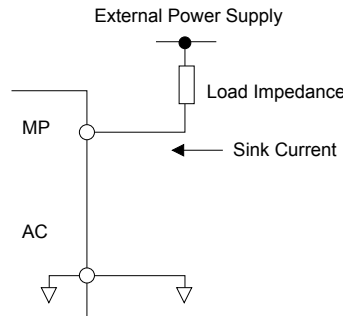

Figure 3.30 Pulse Output Connection Using External Voltage Supply

◆ Terminals A1, A2, and A3 Input Signal Selection

Terminals A1, A2, and A3 can be used to input either a voltage or a current signal. Select the signal type using jumper S1 as explained in [Table 3.12](#). Set parameters H3-01, H3-05, and H3-09 accordingly as shown in [Table 3.13](#).

Note: If terminals A1 and A2 are both set for frequency bias (H3-02 = 0 and H3-10 = 0), both input values will be combined to create the frequency reference.

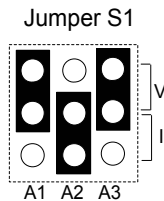

Figure 3.31 Terminal A2 Set to Current Input; A1 and A3 Set to Voltage Input

Table 3.12 Jumper S1 Settings

Setting	Description
V (top position)	Voltage input (-10 to +10 V or 0 to 10 V)
I (bottom position)	Current input (4 to 20 mA or 0 to 20 mA)

Table 3.13 Voltage/Current Selection Parameter Details

No.	Parameter Name	Description	Setting Range	Default Setting
H3-01	Terminal A1 signal level selection	Selects the signal level for terminal A1. 0: 0 to 10 Vdc 1: -10 to 10 Vdc 2: 4 to 20 mA 3: 0 to 20 mA	0 to 3	0
H3-05	Terminal A3 signal level selection	Selects the signal level for terminal A3. 0: 0 to 10 Vdc 1: -10 to 10 Vdc 2: 4 to 20 mA 3: 0 to 20 mA	0 to 3	2
H3-09	Terminal A2 signal level selection	Selects the signal level for terminal A2. 0: 0 to 10 Vdc 1: -10 to 10 Vdc 2: 4 to 20 mA 3: 0 to 20 mA	0 to 3	0

◆ Terminal AM/FM Signal Selection

The signal type for terminals AM and FM can be set to either voltage or current output using jumper S5 on the terminal board as explained in [Table 3.14](#). When changing the setting of jumper S5, parameters H4-07 and H4-08 must be set accordingly. The default selection is voltage output for both terminals.

Table 3.14 Jumper S5 Settings





Terminal	Voltage Output	Current Output
Terminal AM		
Terminal FM		

Table 3.15 Parameter H4-07 and H4-08 Details

No.	Parameter Name	Description	Setting Range	Default Setting
H4-07	Terminal AM signal level selection	0: 0 to 10 Vdc 1: -10 to 10 Vdc	0 to 2	0
H4-08	Terminal FM signal level selection	2: 4 to 20 mA		

3.9 Connect to a PC

This drive is equipped with a USB port (type-B).

The drive can connect to a USB port on a PC using a USB 2.0, AB-type cable (sold separately). After connecting the drive to a PC, Yaskawa DriveWizard Industrial software can be used to monitor drive performance and manage parameter settings. Contact Yaskawa for more information on DriveWizard Industrial.

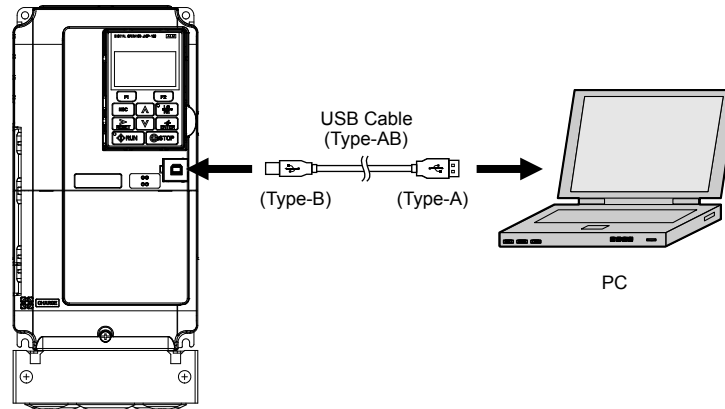

Figure 3.32 Connecting to a PC (USB)

3.10 Wiring Checklist

<input checked="" type="checkbox"/>	No.	Item	Page(s)
Drive, Peripherals, Option Cards			
<input type="checkbox"/>	1	Check drive model number to ensure receipt of correct model.	22
<input type="checkbox"/>	2	Make sure you have the correct braking resistors, DC link chokes, noise filters, and other peripheral devices.	–
<input type="checkbox"/>	3	Check the option card model number.	–
Installation Area and Physical Setup			
<input type="checkbox"/>	4	Ensure that the area surrounding the drive complies with specifications.	26
Power Supply Voltage, Output Voltage			
<input type="checkbox"/>	5	The voltage from the power supply should be within the input voltage specification range of the drive.	96
<input type="checkbox"/>	6	The voltage rating for the motor should match the drive output specifications.	22
<input type="checkbox"/>	7	Verify that the drive is properly sized to run the motor.	221
Main Circuit Wiring			
<input type="checkbox"/>	8	Confirm proper branch circuit protection as specified by national and local codes.	38
<input type="checkbox"/>	9	Properly wire the power supply to drive terminals R/L1, S/L2, and T/L3.	41
<input type="checkbox"/>	10	Properly wire the drive and motor together. The motor lines and drive output terminals R/T1, V/T2, and W/T3 should match in order to produce the desired phase order. If the phase order is incorrect, the drive will rotate in the opposite direction.	57
<input type="checkbox"/>	11	Use 600 Vac vinyl-sheathed wire for the power supply and motor lines.	51
<input type="checkbox"/>	12	Use the correct wire gauges for the main circuit. <i>Refer to Wire Gauges and Tightening Torque on page 51.</i> <ul style="list-style-type: none"> • Consider the amount of voltage drop when selecting wire gauges. Increase the wire gauge when the voltage drop is greater than 2% of motor rated voltage. Ensure the wire gauge is suitable for the terminal block. Use the following formula to calculate the amount of voltage drop: Line drop voltage (V) = $\sqrt{3} \times \text{wire resistance } (\Omega/\text{km}) \times \text{wire length (m)} \times \text{current (A)} \times 10^{-3}$ • If the cable between the drive and motor exceeds 50 m, adjust the carrier frequency set to C6-02 accordingly. 	51 58
<input type="checkbox"/>	13	Properly ground the drive. Review page 58.	58
<input type="checkbox"/>	14	Tighten control circuit and grounding terminal screws. <i>Refer to Wire Gauges and Tightening Torque on page 51.</i>	51
<input type="checkbox"/>	15	Set up overload protection circuits when running multiple motors from a single drive. <div style="text-align: center;"> <p>MC1 - MCn ... magnetic contactor OL 1 - OLn ... thermal relay</p> </div> <p>Note: Close MC1 – MCn before operating the drive. MC1 – MCn cannot be switched off during run.</p>	–
<input type="checkbox"/>	16	Install a magnetic contactor when using a dynamic braking option. Properly install the resistor and ensure that overload protection shuts off the power supply using the magnetic contactor.	–
<input type="checkbox"/>	17	Verify phase advancing capacitors, input noise filters, or GFCIs are NOT installed on the output side of the drive.	–
Control Circuit Wiring			
<input type="checkbox"/>	18	Use twisted-pair line for all drive control circuit wiring.	63
<input type="checkbox"/>	19	Ground the shields of shielded wiring to the GND ⊕ terminal.	63
<input type="checkbox"/>	20	For 3-Wire sequence, set parameters for multi-function contact input terminals S1 – S8, and wire control circuits.	–
<input type="checkbox"/>	21	Properly wire any option cards.	63
<input type="checkbox"/>	22	Check for any other wiring mistakes. Only use a multimeter to check wiring.	–
<input type="checkbox"/>	23	Properly fasten drive control circuit terminal screws. <i>Refer to Wire Gauges and Tightening Torque on page 51.</i>	51
<input type="checkbox"/>	24	Pick up all wire clippings.	–
<input type="checkbox"/>	25	Ensure that no frayed wires on the terminal block are touching other terminals or connections.	–
<input type="checkbox"/>	26	Properly separate control circuit wiring and main circuit wiring.	–
<input type="checkbox"/>	27	Analog signal line wiring should not exceed 50 m.	–
<input type="checkbox"/>	28	Safe Disable input wiring should not exceed 30 m.	–

Start-Up Programming & Operation

This chapter explains the functions of the digital operator and how to program the drive for initial operation.

4.1	USING THE DIGITAL OPERATOR.....	72
4.2	THE DRIVE, PROGRAMMING, AND CLOCK ADJUSTMENT MODES.....	76
4.3	START-UP FLOWCHART.....	82
4.4	POWERING UP THE DRIVE.....	83
4.5	APPLICATION SELECTION.....	84
4.6	BASIC DRIVE SETUP ADJUSTMENTS.....	85
4.7	AUTO-TUNING.....	112
4.8	NO-LOAD OPERATION TEST RUN.....	115
4.9	TEST RUN WITH LOAD CONNECTED.....	117
4.10	TEST RUN CHECKLIST.....	118
4.11	FAN AND PUMP APPLICATION PRESETS.....	119
4.12	FAN AND PUMP APPLICATION PRESET DETAILS.....	122

4.1 Using the Digital Operator

Use the digital operator to enter Run and Stop commands, edit parameters, and display data including fault and alarm information.

◆ Keys and Displays

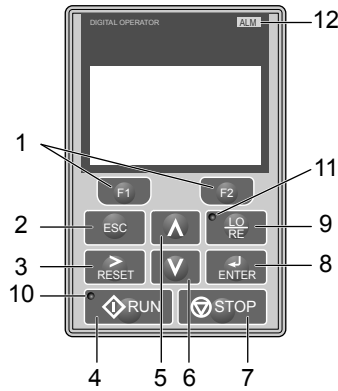

Figure 4.1 Keys and Displays on the Digital Operator

No.	Display	Name	Function
1		Function Key (F1, F2)	The functions assigned to F1 and F2 vary depending on the currently displayed menu. The name of each function appears in the lower half of the display window.
2		ESC Key	<ul style="list-style-type: none"> Returns to the previous display. Moves the cursor one space to the left. Pressing and holding this button will return to the Frequency Reference display.
3		RESET Key	<ul style="list-style-type: none"> Moves the cursor to the right. Resets the drive to clear a fault situation.
4		RUN Key	Starts the drive in LOCAL mode.
5		Up Arrow Key	Scrolls up to display the next item, selects parameter numbers, and increments setting values.
6		Down Arrow Key	Scrolls down to display the previous item, selects parameter numbers, and decrements setting values.
7		STOP Key <1>	Stops drive operation.
8		ENTER Key	<ul style="list-style-type: none"> Enters parameter values and settings. Selects a menu item to move between displays
9		LO/RE Selection Key <2>	Switches drive control between the operator (LOCAL) and an external source (REMOTE) for the Run command and frequency reference.
10		RUN Light	Lit while the drive is operating the motor. Refer to page 74 for details.
11		LO/RE Light	Lit while the operator is selected to run the drive (LOCAL mode). Refer to page 74 for details.
12		ALM LED Light	Refer to ALARM (ALM) LED Displays on page 74.

<1> The STOP key has highest priority. Pressing the STOP key will always cause the drive to stop the motor, even if a Run command is active at any external Run command source. To disable the STOP key priority, set parameter o2-02 to 0.

<2> The LO/RE key can only switch between LOCAL and REMOTE when the drive is stopped. To disable the LO/RE key to prohibit switching between LOCAL and REMOTE, set parameter o2-01 to 0.

◆ LCD Display

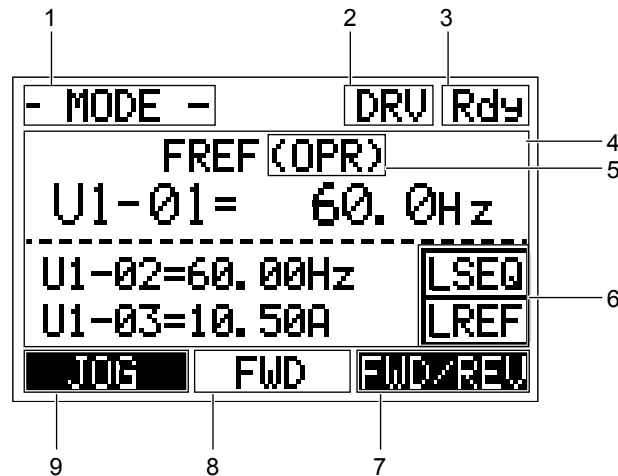











Figure 4.2 LCD Display

Table 4.1 Display and Contents

No.	Name	Display	Content
1	Operation Mode Menus	MODE	Displayed when in Mode Selection.
		MONITR	Displayed when in Monitor Mode.
		VERIFY	Indicates the Verify Menu.
		PRMSET	Displayed when in Parameter Setting Mode.
		A.TUNE	Displayed during Auto-Tuning.
		SETUP	Displayed when in Setup Mode.
2	Mode Display Area	DRV	Displayed when in Drive Mode.
		PRG	Displayed when in Programming Mode.
3	Ready	Rdy	Indicates the drive is ready to run.
4	Data Display	—	Displays specific data and operation data.
5	Frequency Reference Assignment <F2>	OPR	Displayed when the frequency reference is assigned to the LCD Operator Option.
		AI	Displayed when the frequency reference is assigned to the Analog Input of the drive.
		COM	Displayed when the frequency reference is assigned to the MEMOBUS/Modbus Communication Inputs of the drive.
		OP	Displayed when the frequency reference is assigned to an Option Unit of the drive.
		RP	Displayed when the frequency reference is assigned to the Pulse Train Input of the drive.
6	LO/RE Display <F2>	RSEQ	Displayed when the run command is supplied from a remote source.
		LSEQ	Displayed when the run command is supplied from the operator keypad.
		RREF	Displayed when the run command is supplied from a remote source.
		LREF	Displayed when the run command is supplied from the operator keypad.
7	Function Key 2 (F2)	FWD/REV	Pressing  switches between forward and reverse.
		DATA	Pressing  scrolls to the next display.
		→	Pressing  scrolls the cursor to the right.
		RESET	Pressing  resets the existing drive fault error.
8	FWD/REV	FWD	Indicates forward motor operation.
		REV	Indicates reverse motor operation.

4.1 Using the Digital Operator



No.	Name	Display	Content
9	Function Key 1 (F1)	JOG	Pressing  executes the Jog function.
		HELP	Pressing  displays the Help menu.
		←	Pressing  scrolls the cursor to the left.
		HOME	Pressing  returns to the top menu (Frequency Reference).
		ESC	Pressing  returns to the previous display.

<1> Displayed when in Frequency Reference Mode.

<2> Displayed when in Frequency Reference Mode and Monitor Mode.



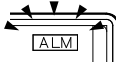



◆ ALARM (ALM) LED Displays

Table 4.2 ALARM (ALM) LED Status and Contents

State	Content	Display
Illuminated	When the drive detects an alarm or error.	
Flashing	<ul style="list-style-type: none"> When an alarm occurs. When an oPE is detected. When a fault or error occurs during Auto-Tuning. 	
Off	Normal operation (no fault or alarm).	

◆ LO/RE LED and RUN LED Indications

Table 4.3 LO/RE LED and RUN LED Indications

LED	Lit	Flashing	Flashing Quickly	Off
	When the operator is selected for Run command and frequency reference control (LOCAL)	—	—	When a device other than the operator is selected for Run command and frequency reference control (REMOTE)
	During run	<ul style="list-style-type: none"> During deceleration to stop When a Run command is input and frequency reference is 0 Hz 	<ul style="list-style-type: none"> While the drive was set to LOCAL, a Run command was entered to the input terminals then the drive was switched to REMOTE. A Run command was entered via the input terminals while the drive was not in Drive Mode. During deceleration when a Fast Stop command was entered. The drive output is shut off by the Safe Disable function. The STOP key was pressed while drive was running in REMOTE. The drive was powered up with b1-17 = 0 (default) while the Run command is active. 	During stop
Examples				

◆ Menu Structure for Digital Operator

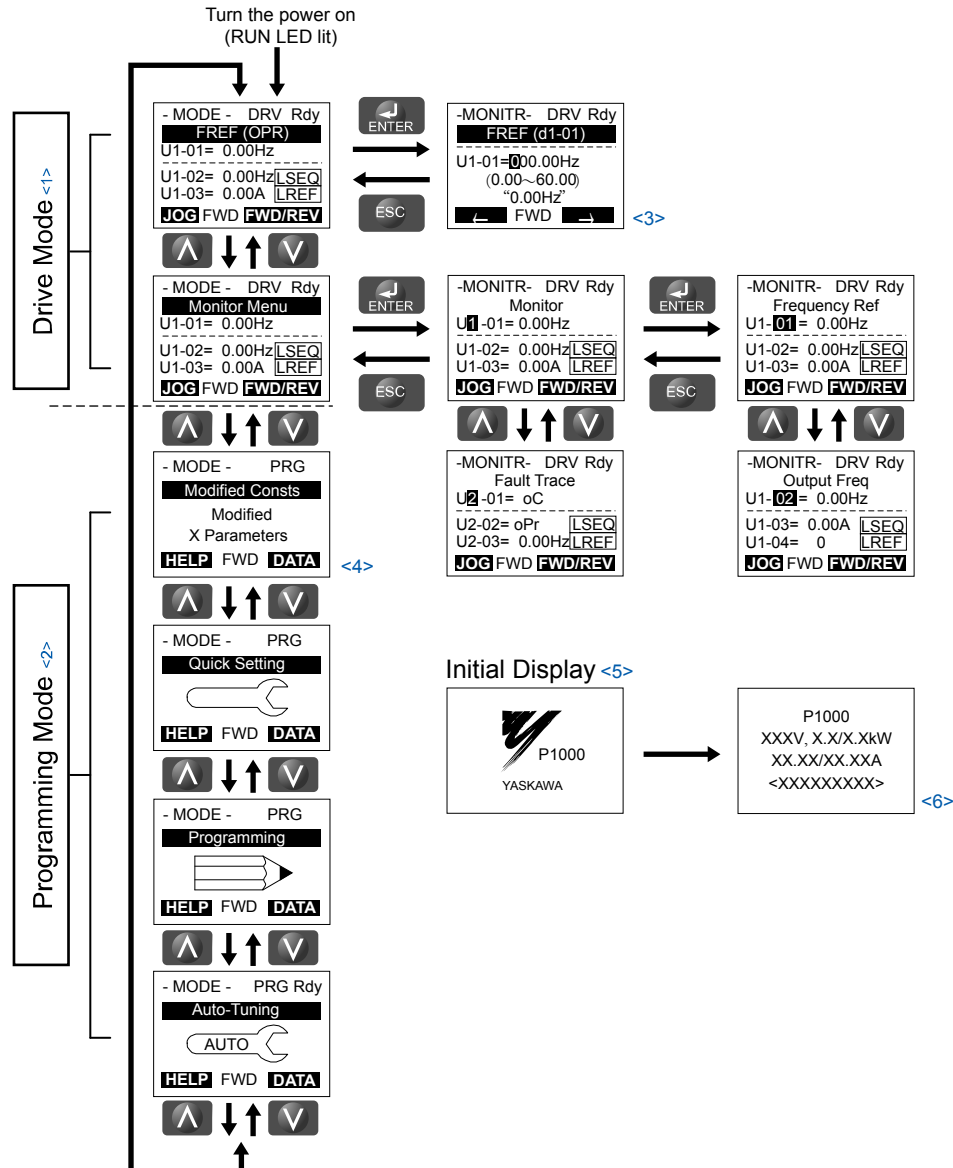



Figure 4.3 Digital Operator Menu and Screen Structure

- <1> Pressing  will start the motor.
- <2> Drive cannot operate motor.
- <3> Flashing characters are shown as **0**.
- <4> "X" characters are used as examples in this manual. The LCD Operator will display the actual setting values.
- <5> The Frequency Reference appears after the initial display that shows the product name.
- <6> The information that appears on the display will vary depending on the drive.

4.2 The Drive, Programming, and Clock Adjustment Modes

The drive has a Drive Mode to operate the motor, a Programming Mode to edit parameter settings, and a Clock Adjustment Mode to adjust the Real Time Clock.

Drive Mode: In Drive Mode the user can operate the motor and observe U Monitor parameters. Parameter settings cannot be edited or changed when in Drive Mode.

Programming Mode: In Programming Mode the user can edit and verify parameter settings and perform Auto-Tuning. When the drive is in Programming Mode it will not accept a Run command unless b1-08 is set to 1.

- Note:**
1. If b1-08 is set to 0, the drive will only accept a Run command in Drive Mode. After editing parameters, the user must exit the Programming Mode and enter Drive Mode before operating the motor.
 2. Set b1-08 to 1 to allow motor operation from the drive while in Programming Mode.

◆ Real-Time Clock (RTC)

The drive has a Clock Adjustment Mode to set and adjust the Real-Time Clock.

Clock Adjustment Mode: When o4-17 is set to 1, the digital operator will show the Clock Adjustment display. In Clock Adjustment Mode, the user can adjust the Real-Time Clock. When the drive is in Clock Adjustment Mode, it will not accept a Run command.

◆ Clock Adjustment

The digital operator will display the Real Time Clock Adjustment Display in [Figure 4.4](#) when the drive is powered up for the first time. [Refer to Manual Clock Adjustment Procedure by Setting o4-17 to 1 on page 77](#) for the Real-Time Clock setting procedure.

Note: Setting the Real-Time Clock will clear a “TIM” alarm.

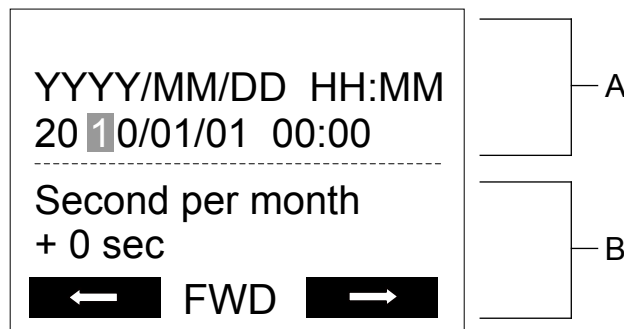

A – Real Time Clock Setting Display B – Gain/Loss Adjustment Display

Figure 4.4 Real Time Clock Adjustment Display

Display	Description
YYYY	Set the year with the last two digits.
MM	Set the month with two digits.
DD	Set the day with two digits.
HH:MM	Set the hours and minutes, with two digits for each.
Second per month	Set the gain or loss in seconds per month.

Moving the Cursor

Pressing the F2 key or the RESET key will move the cursor to the digit on the right. Pressing the F1 key will move the cursor to the left.

Changing Settings

- **Changing YYYY/MM/DD HH:MM:** Pressing the up arrow key will increase the number selected by the cursor from 0 to 9. Pressing the down arrow key will decrease the number selected by the cursor from 0 to 9.
- **Setting the Seconds per Month:** Pressing the up arrow key will increase the number selected by the cursor from -504 to +488 in increments of 8. Pressing the down arrow key will decrease the number selected by the cursor from -504 to +488 in increments of 8.

Verifying the New Time Setting

After pressing ENTER , the display will indicate “Entry accepted” and the new time value will be saved to the Real-Time Clock (RTC).

If there is a problem with the entered time, the operator will indicate “Input error” and the screen will return to the time setting display.

Canceling the Input

Pressing the ESC key will display “Aborted” on the operator, and no value will be saved to the RTC. Pressing OFF will abort the setting process without any display, and no setting changes will be saved to the RTC.

Exiting from the Time Setting Screen Without Making Any Changes

If no changes are entered, the display will exit Real Time Clock Adjustment Display after a few seconds and no changes will be saved.

Real-Time Clock Setting at Initial Power-up of a New Drive

Setting the Real-time clock is required at power-up of a new drive or after digital operator battery replacement.

Table 4.4 illustrates how to set the Real-Time Clock at initial power-up of a new drive.

Table 4.4 Clock Adjustment Procedure at Power-up of a New Drive

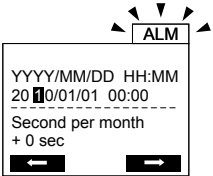
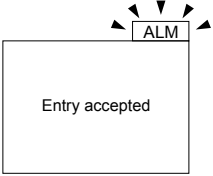
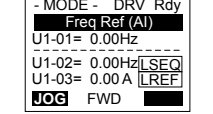
Procedure		Display
1	Turn the power on. The Real Time Clock Adjustment Display will appear. Use the right arrow key to select the desired digit, then set the correct date and time using the up and down arrow keys.	
2	After entering the Real-Time Clock data, press the ENTER key to save the changes. The display will indicate “Entry Accepted” and return to the initial display in step 3 and the alarm LED will be OFF.	
3	Initial display.	

Manual Clock Adjustment by Setting o4-17 to 1

The following actions are possible in the Clock Adjustment Mode:

- Set the current time
- Check the time set to the drive Real-Time Clock

Table 4.5 illustrates how to set the Real-Time Clock manually.

Table 4.5 Manual Clock Adjustment Procedure by Setting o4-17 to 1

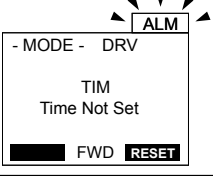
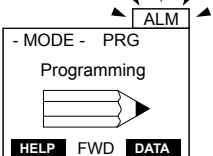
Procedure		Display
1	The “Time Not Set” (TIM) display will appear if the Real-Time Clock data is not entered within 30 seconds of power-up on a new drive. Refer to 137 for details on the TIM display.	
2	Use the up and down arrow keys to scroll through display menu until the screen shows “Programming”.	

4.2 The Drive, Programming, and Clock Adjustment Modes

Procedure		Display
3	Press the ENTER key to enter select the parameter setting mode.	
4	Use the up and down arrow keys to scroll through display menu until parameter o4-17 appears.	
5	Press the ENTER key until "0" flashes.	
6	Press the up arrow key so that the display changes to "1".	
7	Press the ENTER key and the time setting screen will appear. Use the right arrow key to select the desired digit, then set the correct date and time using the up and down arrow keys.	
8	After entering the correct time, press the ENTER key to save the changes. The display will return to the display shown in step 5 and the alarm LED will be OFF.	

■ o4-17: Real-Time Clock Setting

No. (Addr. Hex)	Name	Description	Values
o4-17 (3100)	Set/Reset Real-time Clock Set Time	Sets the current date and time for the Real-Time Clock. 0: — — No Setting ⁰ : — — 1: Real-Time Clock Set 1: Set 2: Real-Time Clock Reset ² : Reset	Default: 0 Range: 0 to 2

Setting 0: — —

No Setting (Default)

Setting 1: Set











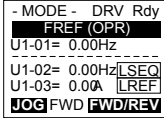

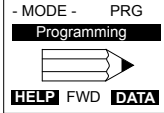

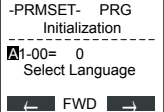

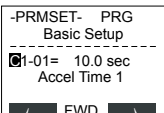

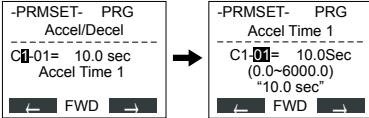

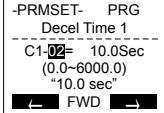

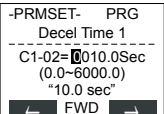
When o4-17 is set to 1, the digital operator will show the Clock Adjustment display. In Clock Adjustment Mode the user can adjust the Real-Time Clock.

Setting 2: Reset

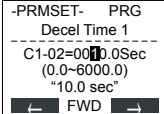
When o4-17 is set to 2, the Real-Time Clock data is cleared. A TIM fault will occur until o4-17 is set to 1 and the Real-Time Clock is set.

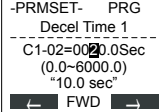
◆ Changing Parameter Settings or Values

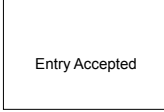
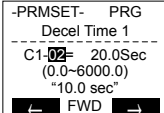
This example explains changing C1-02 (Deceleration Time 1) from 10.0 seconds (default) to 20.0 seconds.

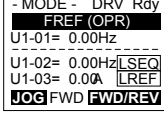
Step		Display/Result
1. Turn on the power to the drive. The initial display appears.	→	
2. Press  or  until the Parameter Setting Mode screen appears.	→	
3. Press  to enter the parameter menu tree.	→	
4. Press  or  to select the C parameter group.	→	
5. Press  two times.	→	
6. Press  or  to select parameter C1-02.	→	
7. Press  to view the current setting value (10.0 s). The leftmost digit flashes.	→	
8. Press  ,  , or  until the desired number is selected. "1" flashes.	→	
9. Press  and enter 0020.0.	→	
10. Press  to confirm the change.	→	
11. The display automatically returns to the screen shown in Step 4.	→	
12. Press  as many times as necessary to return to the initial display.	→	

4.2 The Drive, Programming, and Clock Adjustment Modes

■ Setup Group Parameters

Table 4.6 lists the parameters available by default in the Setup Group. Selecting an Application Preset in through initialization in parameter A1-03 automatically changes the parameters selected for the Setup Group. *Refer to Fan and Pump Application Presets on page 119* for details on parameters and default values for the fan and pump Setup Groups.

No.	Parameter Name	Setting Range	Default
A1-03	Initialize Parameters	0, 1110, 2220, 3330, 5550, 8008, 8009, 8010, 8011	0

Setting 0: No initialization (default)

Setting 1110: User Initialize (parameter values must be stored using parameter o2-03)

Setting 2220: 2-Wire Initialize

Setting 3330: 3-Wire Initialize

Setting 5550: Terminal/Control Initialize

Setting 8008: Pump

Setting 8009: Pump w/ PI

Setting 8010: Fan

Setting 8011: Fan w/ PI

Use the Programming Mode to access parameters not displayed in the Setup Group.

Table 4.6 General Purpose Application Setup Group Parameters (A1-03 = 0)

Parameter	Name	Parameter	Name
A1-06	Application Preset Selection (Monitor only)	E2-01	Motor Rated Current
b1-01	Frequency Reference Selection 1	L2-01	Momentary Power Loss Operation Selection
b1-02	Run Command Selection 1	L5-01	Number of Auto Restart Attempts
b1-03	Stopping Method Selection	L6-01	Torque Detection 1 Selection
b1-04	Reverse Operation Selection	L6-02	Torque Detection 1 Level
C1-01	Acceleration Time 1	L6-03	Torque Detection 1 Time
C1-02	Deceleration Time 1	o1-06	User Monitor Selection Mode
d1-01	Frequency Reference 1	o1-07	Second Line Monitor Selection
d2-01	Frequency Reference Upper Limit	o1-08	Third Line Monitor Selection
d2-02	Frequency Reference Lower Limit		

◆ Switching Between LOCAL and REMOTE





LOCAL mode is when the drive is set to accept the Run command from the digital operator RUN key. REMOTE mode is when the drive is set to accept the Run command from an external device (i.e., input terminals or serial communications).

WARNING! *Sudden Movement Hazard. The drive may start unexpectedly if the Run command is already applied when switching from LOCAL mode to REMOTE mode when b1-07 = 1, resulting in death or serious injury. Be sure all personnel are clear of rotating machinery.*

Switch the operation between LOCAL and REMOTE using the LO/RE key on the digital operator or via a digital input.

- Note:**
1. After selecting LOCAL, the LO/RE light will remain lit.
 2. The drive will not allow the user to switch between LOCAL and REMOTE during run.

■ Using the LO/RE Key on the Digital Operator

Step		Display/Result
1.	Turn on the power to the drive. The initial display appears.	
2.	Press  . The LO/RE light will light up. The drive is now in LOCAL. To set the drive for REMOTE operation, press the  key again.	 

■ Using Input Terminals S1 through S8 to Switch between LOCAL and REMOTE

It is possible to switch between LOCAL and REMOTE modes using one of the digital input terminals S1 through S8 (set the corresponding parameter H1-□□ to “1”).

Setting H1-□□ to 1 disables the LO/RE key on the digital operator. *Refer to H1: Multi-Function Digital Inputs on page 196* for details.

4.3 Start-Up Flowchart

Figure 4.5 summarizes steps required to start the drive and gives quick references to help familiarize the user with start-up procedures.

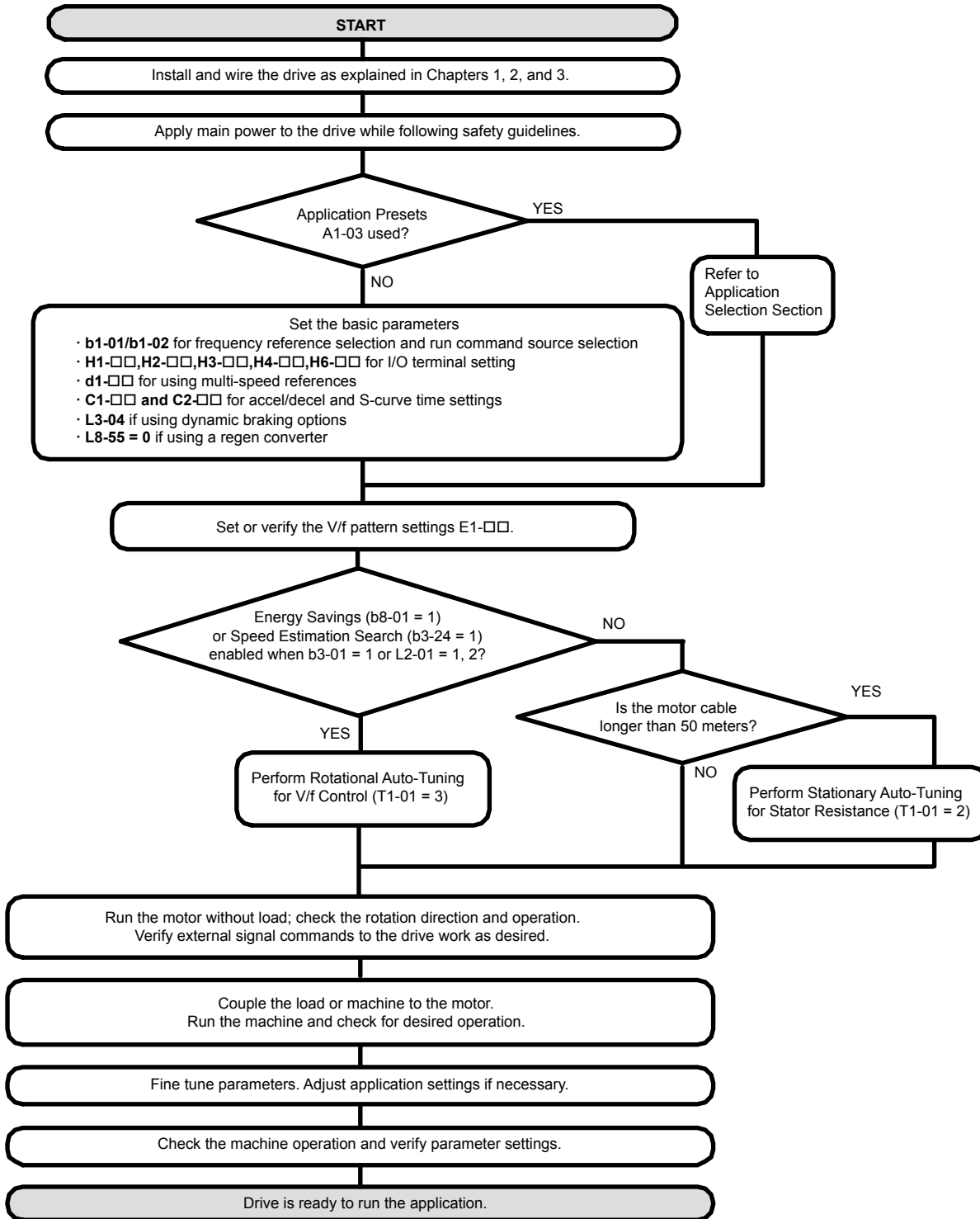

Figure 4.5 Simple Setup with Energy Savings or Speed Search

- Note:**
1. Execute Stationary Auto-Tuning for Line-to-Line Resistance if the drive has been Auto-Tuned and then moved to a different location where the motor cable length exceeds 50 m.
 2. Perform Auto-Tuning again after installing an AC reactor or other such components to the output side of the drive.

4.4 Powering Up the Drive

◆ Powering Up the Drive and Operation Status Display



■ Powering Up the Drive

Review the following checklist before turning the power on.

Item to Check	Description
Power supply voltage	200 V class: Three-phase 200 to 240 Vac 50/60 Hz 400 V class: Three-phase 380 to 480 Vac 50/60 Hz 600 V class: Three-phase 500 to 600 Vac 50/60 Hz
	Properly wire the power supply input terminals (R/L1, S/L2, T/L3).
	Check for proper grounding of drive and motor.
Drive output terminals and motor terminals	Properly wire drive output terminals U/T1, V/T2, and W/T3 with motor terminals U, V, and W.
Control circuit terminals	Check control circuit terminal connections.
Drive control terminal status	Open all control circuit terminals (off).
Status of the load and connected machinery	Decouple the motor from the load.

■ Status Display

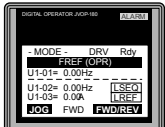
When the power supply to the drive is turned on, the digital operator lights will appear as follows:

Status	Name	Description
Normal Operation		The data display area displays the frequency reference. [DRV] is lit.
Fault	 External fault (example)	Data displayed varies by the type of fault. <i>Refer to Fault Displays, Causes, and Possible Solutions on page 129</i> for more information. [ALM] and [DRV] are lit.

4.5 Application Selection

Application Presets are available to facilitate drive setup for commonly used applications. Selecting one of these Application Presets automatically assigns functions to the input and output terminals and sets a predefined group of parameters to values appropriate for the selected application.

In addition, the parameters most likely to be changed are assigned to the group of User Parameters, A2-01 through A2-16. User Parameters are part of the Setup Group, which provides quicker access by eliminating the need to scroll through multiple menus.

- Note:**
1. Application Presets can only be selected if all drive parameters are at their original default settings.
 2. Entering a value to A1-03 to enable an Application Preset will fix that value to the parameter. The value cannot be changed without first setting A1-03 to 2220 or 3330 to initialize the drive.

WARNING! *Sudden Movement Hazard. Confirm the drive I/O signals and external sequence before performing a test run. Setting parameter A1-03 may automatically change the I/O terminal function from the default setting. Failure to comply may result in death or serious injury.*

No.	Parameter Name	Settings	Default
A1-03	Initialize Parameters	0: No initialization (default) 1110: User Initialize (parameter values must be stored using parameter o2-03) 2220: 2-Wire Initialize 3330: 3-Wire Initialize 5550: Terminal/Control Initialize 8008: Pump </> 8009: Pump w/ PI </> 8010: Fan </> 8011: Fan w/ PI </>	0
A1-06	Application Presets (monitor only)	0: Disabled 8: Pump 9: Pump w/ PI 10: Fan 11: Fan w/ PI	0

<1> [Refer to Fan and Pump Application Presets on page 119](#) for drive setup using A1-03 = 8008, 8009, 8010, or 8011.

4.6 Basic Drive Setup Adjustments

This section explains the basic settings required for initial drive operation. Checking these basic parameter settings will help to ensure a successful drive start-up. [Refer to Parameter List on page 177](#) for a complete listing of drive parameters if more information is required for parameters not listed in this section.

■ A1-03: Initialize Parameters

Resets parameters to default values or performs an Application Preset for fan or pump applications. After initialization, the setting for A1-03 automatically returns to 0.

No.	Parameter Name	Setting Range	Default
A1-03	Initialize Parameters	0, 1110, 2220, 3330, 5550, 8008, 8009, 8010, 8011	0

Setting 1110: User Initialize

Resets parameters to the values selected by the user as User Settings. User Settings are stored when parameter o2-03 is set to “1: Set defaults”.

Note: User Initialization resets all parameters to a user-defined set of default values previously saved to the drive. Set parameter o2-03 to 2 to clear the user-defined default values.

Setting 2220: 2-Wire Initialization

Resets parameters to default settings with digital inputs S1 and S2 configured as Forward run and Reverse run, respectively.

Setting 3330: 3-Wire Initialization

Resets parameters to default settings with digital inputs S1, S2, and S5 configured as Run, Stop, and Forward/Reverse respectively. [Refer to Setting 0: 3-Wire Sequence on page 102](#) for more information on digital input functions.

Notes on Parameter Initialization

The parameters shown in [Table 4.7](#) will not be reset when the drive is initialized by setting A1-03 = 2220 or 3330.

Table 4.7 Parameters Not Changed by Drive Initialization

No.	Parameter Name
A1-00	Language Selection
E1-03	V/f Pattern Selection
F6-08	Communication Parameter Reset
L8-35	Installation Selection
o2-04	Drive/kVA Selection

Setting 5550: Terminal/Control Initialize

An oPE04 error appears on the digital operator when a terminal block with settings saved to its built-in memory is installed in a drive that has edited parameters. Set A1-03 to 5550 to use the parameter settings saved to the terminal block memory.

Setting 8008: Pump

Application Preset for pump applications. [Refer to Fan and Pump Application Presets on page 119](#) for a list of parameters and default values for this Application Preset.

Setting 8009: Pump w/ PI

Application Preset for pump with PI applications. [Refer to Fan and Pump Application Presets on page 119](#) for a list of parameters and default values for this Application Preset.

Setting 8010: Fan

Application Preset for fan applications. [Refer to Fan and Pump Application Presets on page 119](#) for a list of parameters and default values for this Application Preset.

Setting 8011: Fan w/ PI

Application Preset for fan with PI applications. [Refer to Fan and Pump Application Presets on page 119](#) for a list of parameters and default values for this Application Preset.

4.6 Basic Drive Setup Adjustments

■ b1-01: Frequency Reference Selection 1

Selects the frequency reference source 1 for the REMOTE mode.

- Note:**
1. If a Run command is input to the drive but the frequency reference entered is 0 or below the minimum frequency, the RUN indicator LED on the digital operator will light and the STOP indicator will flash.
 2. Press the LO/RE key to set the drive to LOCAL and use the operator keypad to enter the frequency reference.

No.	Parameter Name	Setting Range	Default
b1-01	Frequency Reference Selection 1	0 to 4	1

Setting 0: Operator keypad

Using this setting, the frequency reference can be input by:

- switching between the multi-speed references in the d1-□□ parameters.
- entering the frequency reference on the operator keypad.

Setting 1: Terminals (analog input terminals)

Using this setting, an analog frequency reference can be entered as a voltage or current signal from terminals A1, A2, or A3.

Voltage Input

Voltage input can be used at any of the three analog input terminals. Make the settings as described in [Table 4.8](#) for the input used.

Table 4.8 Analog Input Settings for Frequency Reference Using Voltage Signals

Terminal	Signal Level	Parameter Settings				Notes
		Signal Level Selection	Function Selection	Gain	Bias	
A1	0 to 10 Vdc	H3-01 = 0	H3-02 = 0 (Frequency Reference Bias)	H3-03	H3-04	-
	-10 to +10 Vdc	H3-01 = 1				
A2	0 to 10 Vdc	H3-09 = 0	H3-10 = 0 (Frequency Reference Bias)	H3-11	H3-12	Set jumper S1 on the terminal board to “V” for voltage input.
	-10 to +10 Vdc	H3-09 = 1				
A3	0 to 10 Vdc	H3-05 = 0	H3-06 = 0 (Frequency Reference Bias)	H3-07	H3-08	Set DIP switch S4 on the terminal board to “AI”.
	-10 to +10 Vdc	H3-05 = 1				

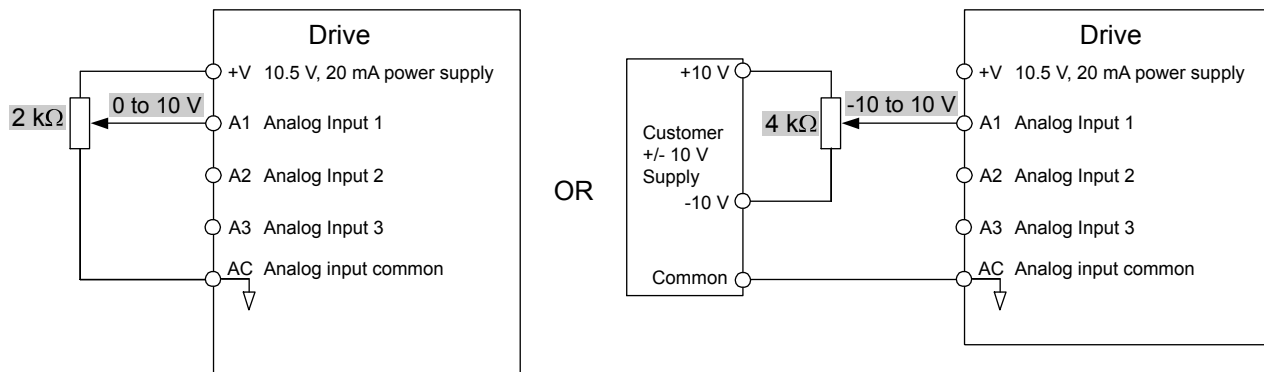

Figure 4.6 Setting the Frequency Reference as a Voltage Signal at Terminal A1

Current Input

Input terminals, A1, A2, and A3 can accept a current input signal. Refer to [Table 4.9](#) for an example to set terminal A2 for current input.

Table 4.9 Analog Input Settings for Frequency Reference Using a Current Signal

Terminal	Signal Level	Parameter Settings				Notes
		Signal Level Selection	Function Selection	Gain	Bias	
A2	4 to 20 mA	H3-09 = 2	H3-10 = 0 (Frequency Bias)	H3-11	H3-12	Make sure to set jumper S1 on the terminal board to “I” for current input.
	0 to 20 mA	H3-09 = 3				

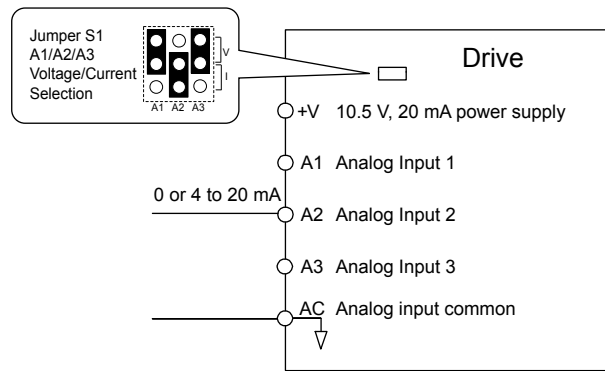

Figure 4.7 Setting the Frequency Reference as a Current Signal to Terminal A2

Switching between Main/Auxiliary Frequency References

The frequency reference input can be switched between the analog terminals A1, A2, and A3 using multi-speed inputs. Refer to *Multi-Step Speed Selection on page 95* for details on using this function.

Setting 2: MEMOBUS/Modbus Communications

This setting requires entering the frequency reference via the RS-485/422 serial communications port (control terminals R+, R-, S+, S-).

Setting 3: Option card

This setting requires entering the frequency reference via an option board plugged into connector CN5-A on the drive control board. Consult the option board manual for instructions on integrating the drive with the communication system.

Note: If the frequency reference source is set for Option PCB (b1-01 = 3), but an option board is not installed, an oPE05 Operator Programming Error will be displayed on the digital operator and the drive will not run.

Setting 4: Pulse Train Input

This setting requires a pulse train signal to terminal RP to provide the frequency reference. Follow the directions below to verify that the pulse signal is working properly.

Verifying the Pulse Train is Working Properly

- Set b1-04 to 4 and set H6-01 to 0.
- Set the H6-02 to the pulse train frequency value that equals 100% of the frequency reference.
- Enter a pulse train signal to terminal RP and check for the correct frequency reference on the display.

■ b1-02: Run Command Selection 1

Determines the Run command source 1 in the REMOTE mode.

No.	Parameter Name	Setting Range	Default
b1-02	Run Command Selection 1	0 to 3	1

Setting 0: Operator

This setting requires entering the Run command via the digital operator RUN key and also illuminates the LO/RE indicator on the digital operator.

Setting 1: Control Circuit Terminal

This setting requires entering the Run command via the digital input terminals using one of following sequences:

- 2-Wire sequence 1:
Two inputs (FWD/Stop-REV/Stop). Set A1-03 to 2220 to initialize the drive and preset terminals S1 and S2 to these functions. This is the default setting of the drive.
- 2-Wire sequence 2:
Two inputs (Start/Stop-FWD/REV).
- 3-Wire sequence:
Three inputs (Start-Stop-FWD/REV). Set A1-03 to 3330 to initialize the drive and preset terminals S1, S2, and S5 to these functions. Refer to *Setting 0: 3-Wire Sequence on page 102*.

4.6 Basic Drive Setup Adjustments

Setting 2: MEMOBUS/Modbus Communications

This setting requires entering the Run command via serial communications by connecting the RS-485/422 serial communication cable to control terminals R+, R-, S+, and S- on the removable terminal block.

Setting 3: Option Card

This setting requires entering the Run command via the communication option board by plugging a communication option board into the CN5-A port on the control PCB. Refer to the option board manual for instructions on integrating the drive into the communication system.

Note: If b1-02 is set to 3, but an option board is not installed in CN5-A, an oPE05 operator programming error will be displayed on the digital operator and the drive will not run.

■ b1-03: Stopping Method Selection

Selects how the drive stops the motor when the Run command is removed or when a Stop command is entered.

No.	Parameter Name	Setting Range	Default
b1-03	Stopping Method Selection	0 to 3	0

Setting 0: Ramp to Stop

When the Run command is removed, the drive will decelerate the motor to stop. The deceleration rate is determined by the active deceleration time. The default deceleration time is set to parameter C1-02.

When the output frequency falls below the level set in parameter b2-01, the drive will start DC injection, Zero Speed Control, or Short Circuit Braking. [Refer to b2-01: DC Injection Braking Start Frequency on page 90](#) for details.

Setting 1: Coast to Stop

When the Run command is removed, the drive will shut off its output and the motor will coast (uncontrolled deceleration) to stop. The stopping time is determined by the inertia and the friction in the driven system.

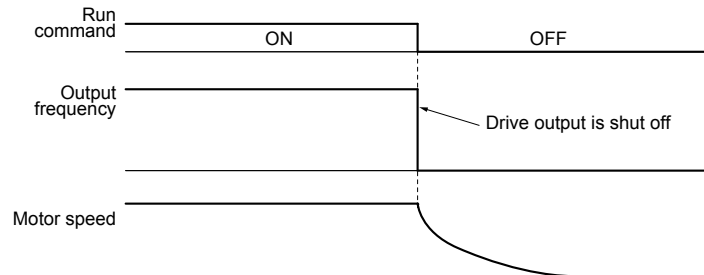

Figure 4.8 Coast to Stop

Note: After a stop is initiated, any subsequent Run command entered will be ignored until the minimum baseblock time (L2-03) has expired. Do not enter Run command until it has come to a complete stop. Use DC Injection at Start ([Refer to b2: DC Injection Braking and Short Circuit Braking on page 179](#)) or Speed Search ([Refer to b3: Speed Search on page 180](#)) to restart the motor before it has completely stopped.

Setting 2: DC Injection Braking to Stop

When the Run command is removed, the drive will enter baseblock (turn off its output) for the minimum baseblock time (L2-03). When the minimum baseblock time has expired, the drive will inject the amount DC Injection Braking is set in parameter b2-02 into the motor windings to brake the motor. The stopping time in DC Injection Braking to Stop is significantly faster compared to Coast to Stop.

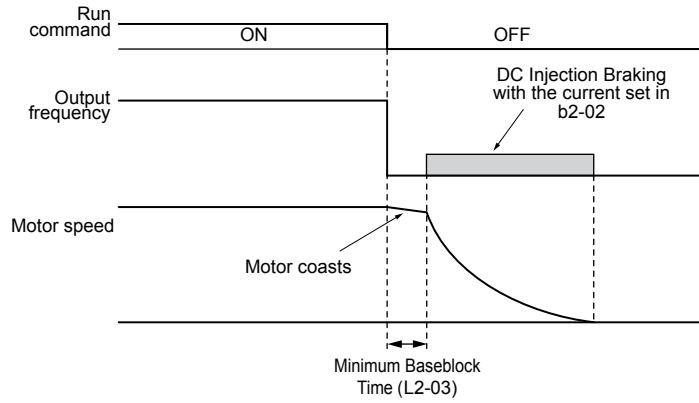

Figure 4.9 DC Injection Braking to Stop

DC Injection Braking time is determined by the value set to b2-04 and the output frequency at the time the Run command is removed. It can be calculated by:

$$\text{DC Injection brake time} = \frac{(b2-04) \times 10 \times \text{Output frequency}}{\text{Max. output frequency (E1-04)}}$$

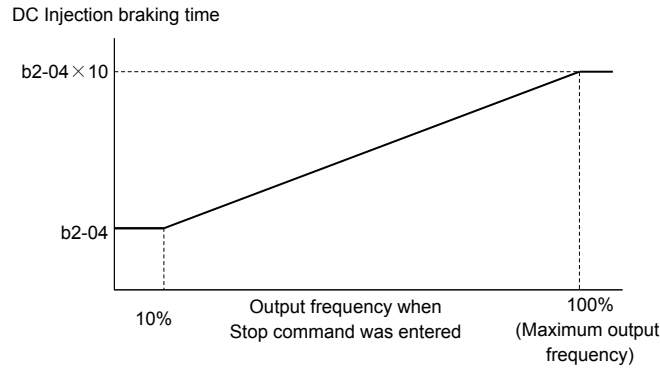

Figure 4.10 DC Injection Braking Time Depending on Output Frequency

Note: If an overcurrent (oC) fault occurs during DC Injection Braking to Stop, lengthen the minimum baseblock time (L2-03) until the fault no longer occurs.

Setting 3: Coast to Stop with Timer

When the Run command is removed, the drive will turn off its output and the motor will coast to stop. The drive will not start if a Run command is input before the time t (C1-02) has expired. Cycle the Run command that was activated during time t after t has expired to start the drive.

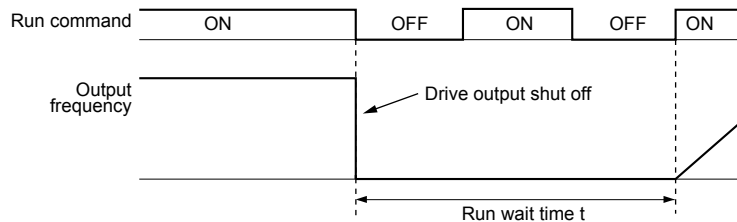

Figure 4.11 Coast to Stop with Timer

The wait time t is determined by the output frequency when the Run command is removed and by the active deceleration time.

4.6 Basic Drive Setup Adjustments

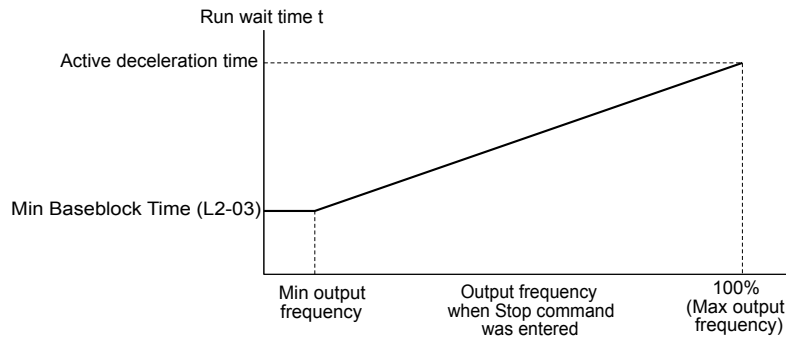

Figure 4.12 Run Wait Time Depending on Output Frequency

■ b2-01: DC Injection Braking Start Frequency

Active when “Ramp to Stop” is selected as the stopping method (b1-03 = 0).

No.	Name	Setting Range	Default
b2-01	DC Injection Braking Start Frequency	0.0 to 10.0 Hz	0.5

V/f Control

Sets the starting frequency for DC Injection Braking at Stop. When the output frequency falls below the setting of b2-01, DC Injection Braking is enabled for the time set in parameter b2-04.

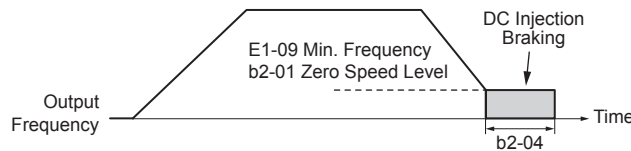

Figure 4.13 DC Injection Braking at Stop for V/f

Note: If b2-01 is set to a smaller value than E1-09 (Minimum Frequency), then DC Injection Braking will begin when the frequency falls to the E1-09 value.

■ b3-01: Speed Search Selection at Start

Determines if Speed Search is automatically performed when a Run command is issued.

No.	Parameter Name	Setting Range	Default
b3-01	Speed Search Selection at Start	0, 1	0

Setting 0: Disabled

This setting starts operating the drive at the minimum output frequency when the Run command is entered. If external Speed Search 1 or 2 is already enabled by a digital input, the drive will start operating with Speed Search.

Setting 1: Enabled

This setting performs Speed Search when the Run command is entered. The drive begins running the motor after Speed Search is complete.

◆ EZ Sleep/Wake-up Function

To enable EZ Sleep/Wake-up functionality on the drive, first set parameter b5-89 to 1. The default setting for b5-89 is 0, which disables the EZ Sleep functionality and related parameters, except for parameter b5-91, EZ Sleep Minimum Speed.

Setting b5-89 to 1 disables the existing PID Sleep function (b5-15) and enables the EZ Sleep/Wake-up functionality.

EZ Sleep and Minimum Speed Units

Parameter b5-90, EZ Sleep Unit, determines the unit, range, and resolution of parameters b5-92 and b5-93. When set to Hz, the range is 0.1 to 400.0 Hz. When set to RPM, the range is 0 to 24000 RPM. Changing b5-90 will NOT automatically re-scale the values of b5-92 and b5-93.

Minimum Speed

Parameter b5-91, EZ Minimum Speed, acts as a lower limit on the PID output. This value is internally limited to the higher value between b5-34 or d2-02 and is active regardless of the b5-89 setting. When this limit is active, the PID integrator will be held to avoid integral wind-up. Parameter b5-90 determines whether the value is input in Hz or RPM.

Sleep

When the output frequency (or speed) is at or below the EZ Sleep Level (b5-92) for the time set in EZ Sleep Time (b5-93), the drive will sleep. The EZ Sleep Level is internally lower limited to the b5-92 setting.

Wake-up using Absolute Level (b5-95 = 0)

For Normal Acting PID, the PID Feedback must drop below the EZ Wake-up Level (b5-94) for the time set in EZ Wake-up Time (b5-96) in order for the drive to wake-up.

For Reverse Acting PID, the PID Feedback must rise above the b5-94 level for the time set in b5-96 in order for the drive to wake-up.

Wake-up using Setpoint Delta Level (b5-95 = 1)

For Normal Acting PID, the wake-up level is determined by the PID Setpoint minus the b5-94 level. The PID Feedback must drop below the wake-up level for the time set in b5-96 in order for the drive to wake-up.

For Reverse Acting PID, the wake-up level is determined by the PID Setpoint plus the b5-94 level. The PID Feedback must rise above the wake-up level for the time set in b5-96 in order for the drive to wake-up.

Refer to [Figure 4.14](#) and [Figure 4.15](#) for detailed diagrams of EZ Sleep/Wake-up functions.

Refer to [Table 4.10](#) for descriptions of EZ Sleep/Wake-up parameters.

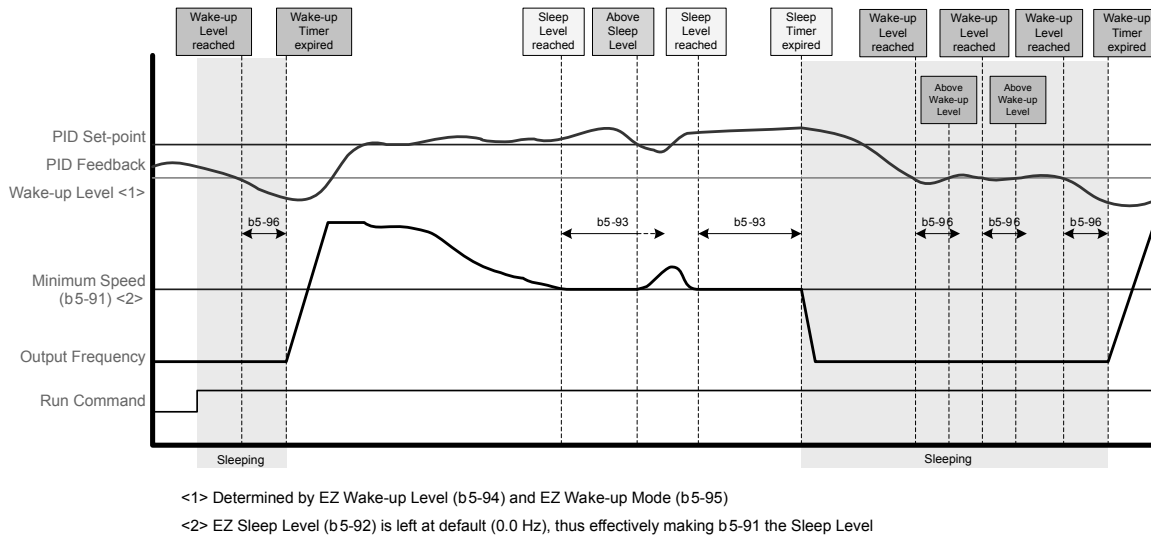

Figure 4.14 EZ Sleep/Wake-up with Normal Acting PID and b5-92 = 0.0 Hz

4.6 Basic Drive Setup Adjustments

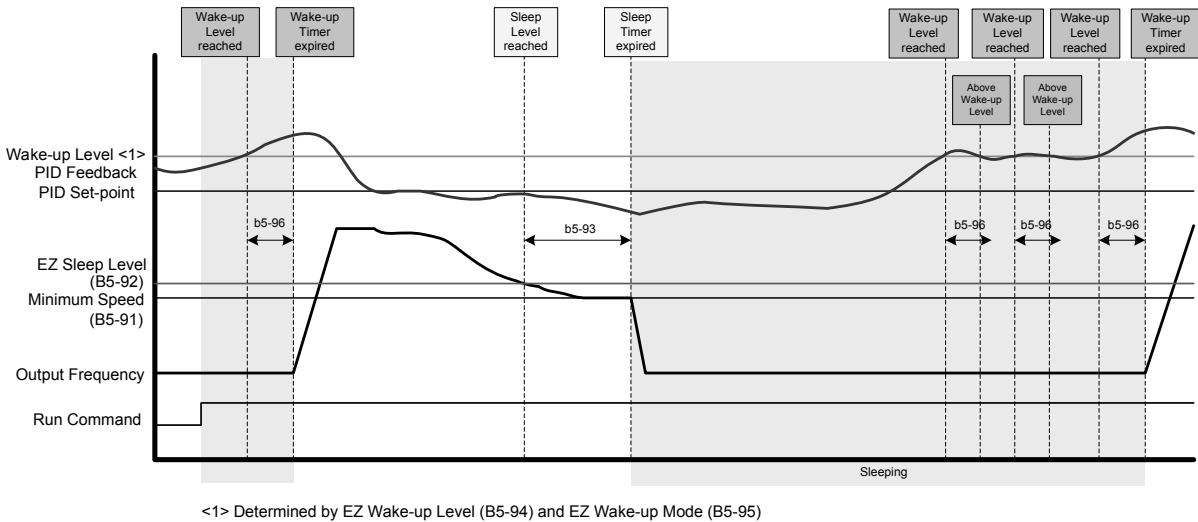

Figure 4.15 EZ Sleep/Wake-up with Reverse Acting PID and b5-92 > b5-91

Table 4.10 EZ Sleep/Wake-up Parameters

No.	Name	Description	Values
b5-20	PID Setpoint Scaling	0: 0.01 Hz units 1: 0.01% units (100% = max output frequency) 2: RPM (number of motor poles must be entered) 3: User-set (set scaling to b5-38 and b5-39, units based on b5-46 setting)	Default: 1 Range: 0 to 3
b5-38	PID Setpoint User Display	Scales the PID units to the maximum output frequency.	Default: 1000 Min.: 1 Max.: 60000
b5-39	PID Setpoint Display Digits	0: No decimal places 1: One decimal place 2: Two decimal places 3: Three decimal places	Default: 2 Range: 0 to 3
b5-46	PID Units Selection	Sets the display units for parameter b5-19, and monitors U5-01, U5-04 and U5-99 0: WC (Inch of water) 1: PSI (Pounds per square inch) 2: GPM (Gallons per minute) 3: F (Degrees Fahrenheit) 4: CFM (Cubic feet per minute) 5: CMH (Cubic meters per hour) 6: LPH (Liters per hour) 7: LPS (Liters per second) 8: Bar (Bar) 9: Pa (Pascal) 10: C (Degrees Celsius) 11: Mtr (Meters) 12: Ft (Feet) 13: LPM (Liters per minute) 14: CMM (Cubic meters per minute) 15: "Hg (Inches of Mercury) 25: None	Default: 0 Range: 0 to 15; 25
b5-89	Sleep Method Selection	Determines how the drive sleeps and wakes-up when using PID. 0: Standard 1: EZ Sleep/Wake-up	Default: 0 Range: 0, 1
b5-90 </>	EZ Sleep Unit	Sets the unit, range, and resolution of parameters b5-91 and b5-92. 0: Hz 1: RPM (number of motor poles must be entered)	Default: 0 Range: 0, 1
b5-91 </>	EZ Minimum Speed	Sets the PID minimum speed and integral lower limit. The internal value is lower limited to the higher setting between b5-34 and d2-02.	Default: 0.0 Hz Range: 0.0 to 400.0 Hz or 0 to 24000 RPM </>

No.	Name	Description	Values
b5-92 <1>	EZ Sleep Level	The drive will go to sleep when the drive output frequency (or speed) is at or below this level for the time set in b5-93. This parameter is internally lower limited to b5-91 (EZ Min Speed) + 1 Hz.	Default: 0.0 Hz Range: 0.0 to 400.0 Hz or 0 to 24000 RPM <2>
b5-93 <1>	EZ Sleep Time	The drive will go to sleep when the drive output frequency is at or below the level set to b5-92 for the time set in this parameter.	Default: 5.0 s Min.: 0.0 Max.: 1000.0
b5-94 <1> <1>	EZ Wake-up Level	When b5-95 is set to 0 (Absolute), the drive wakes-up when the PID Feedback (H3-□□ = 20) drops below this level for the time set in b5-96. For reverse-acting, the PID Feedback must be above this level for the time set in b5-96. When b5-95 is set to 1 (Setpoint Delta), the drive wakes-up when the PID Feedback (H3-□□ = 20) drops below the PID Setpoint minus this level (for normal acting PID) for the time set in b5-96. For reverse-acting, Wake-up level is PID Setpoint plus this level. The PID Feedback must be above the wake-up level for the time set in b5-96.	Default: 0.00% Min.: 0.00 Max.: 600.00
b5-95 <1>	EZ Wake-up Mode	Sets how the wake-up level is determined. 0: Absolute 1: Setpoint Delta	Default: 0 Range: 0, 1
b5-96 <1>	EZ Wake-up Time	The drive will wake up when the PID Feedback drops below the b5-94, EZ Wake-up Level for the time set in this parameter.	Default: 1.0 s Min.: 0.0 Max.: 1000.0

<1> Parameter is only effective when EZ Sleep is enabled by setting b5-89 to 1.

<2> Unit, range and resolution is determined by b5-90. Changing b5-90 will not automatically update the value of this parameter.

■ C1-01 to C1-04: Accel, Decel Times 1 and 2

Two different sets of acceleration and deceleration times can be set in the drive by digital inputs, motor selection, or switched automatically.

Acceleration time parameters always set the time to accelerate from 0 Hz to the maximum output frequency (E1-04).

Deceleration time parameters always set the time to decelerate from maximum output frequency to 0 Hz. C1-01 and C1-02 are the default active accel/decel settings.

No.	Parameter Name	Setting Range	Default
C1-01	Acceleration Time 1	0.0 to 6000.0 s <1>	10.0 s
C1-02	Deceleration Time 1		
C1-03	Acceleration Time 2		
C1-04	Deceleration Time 2		

<1> The setting range for the acceleration and deceleration times is determined by the accel/decel time setting units in C1-10. For example, if the time is set in units of 0.01 s (C1-10 = 0), the setting range becomes 0.00 to 600.00 s.

Switching Acceleration Times by Digital Input

Accel/decel time 1 is active by default if no input is set. Activate accel/decel times 2, 3, and 4 by digital inputs (H1-□□ = 7 and 1A) as explained in [Table 4.11](#).

Table 4.11 Accel/Decel Time Selection by Digital Input

Accel/Decel Time Sel. 1 H1-□□ = 7	Accel/Decel Time Sel. 2 H1-□□ = 1A	Active Times	
		Acceleration	Deceleration
0	0	C1-01	C1-02
1	0	C1-03	C1-04

[Figure 4.16](#) shows an operation example for changing accel/decel. times. The example below requires that the stopping method be set for “Ramp to stop” (b1-03 = 0).

4.6 Basic Drive Setup Adjustments

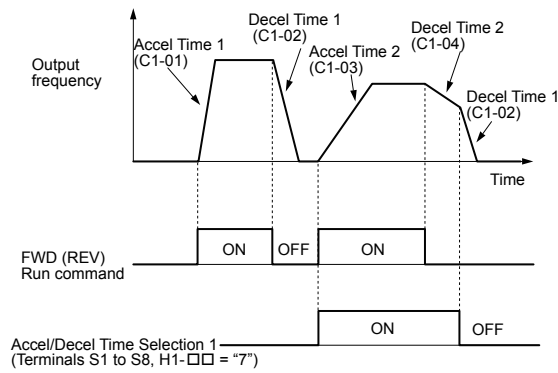

Figure 4.16 Timing Diagram of Accel/Decel Time Change

■ C6-02: Carrier Frequency Selection

Sets the switching frequency of the drive output transistors. Changes to the switching frequency lower audible noise and reduce leakage current.

Note: Increasing the carrier frequency above the default value automatically lowers the drive current rating.

No.	Parameter Name	Setting Range	Default
C6-02	Carrier Frequency Selection	1 to F	7

Settings:

C6-02	Carrier Frequency	C6-02	Carrier Frequency	C6-02	Carrier Frequency
1	2.0 kHz	5	12.5 kHz	9	Swing PWM 3
2	5.0 kHz	6	15.0 kHz	A	Swing PWM 4
3	8.0 kHz	7	Swing PWM 1	F	User defined (C6-03 to C6-05)
4	10.0 kHz	8	Swing PWM 2		

Note: Swing PWM uses a carrier frequency of 2.0 kHz as a base, then applies a special PWM pattern to reduce the audible noise.

Guidelines for Carrier Frequency Parameter Setup

Symptom	Remedy
Speed and torque are unstable at low speeds	Lower the carrier frequency.
Noise from the drive affects peripheral devices	
Excessive leakage current from the drive	
Wiring between the drive and motor is too long <1>	
Audible motor noise is too loud	Increase the carrier frequency or use Swing PWM. <2>

<1> The carrier frequency may need to be lowered if the motor cable is too long. Refer to [Table 4.12](#).

<2> The default carrier frequency is Swing PWM (C6-02 = 7), using a 2 kHz base. Increasing the carrier frequency is permissible, however the drive rated current is reduced when the carrier frequency is increased.

Table 4.12 Wiring Distance and Carrier Frequency

Wiring Distance	Up to 50 m	Up to 100 m	Greater than 100 m
Recommended setting value for C6-02	1 to F (up to 15 kHz)	1 to 2 (up to 5 kHz), 7 (Swing PWM)	1 (up to 2 kHz), 7 (Swing PWM)

■ d1-01 to d1-17: Frequency Reference 1 to 16 and Jog Frequency Reference

The drive lets the user switch between up to 17 preset frequency references during run (including the Jog reference) through the digital input terminals. The drive uses the acceleration and deceleration times that have been selected when switching between each frequency reference.

The Jog frequency overrides all other frequency references and must be selected by a separate digital input.

The multi-speed references 1, 2, and 3 can be provided by analog inputs.

No.	Parameter Name	Setting Range	Default
d1-01 to d1-16	Frequency Reference 1 to 16	0.00 to 400.00 Hz </>	0.00 Hz
d1-17	Jog Frequency Reference	0.00 to 400.00 Hz </>	6.00 Hz

<1> The upper limit is determined by the maximum output frequency (E1-04) and upper limit for the frequency reference (d2-01).

Multi-Step Speed Selection

To use several speed references for a multi-step speed sequence, set the H1-□□ parameters to 3, 4, 5, and 32. To assign the Jog reference to a digital input, set H1-□□ to 6.

Notes on using analog inputs as Multi-Speed 1, 2, and 3:

• **Multi-Step Speed 1**

- Set b1-01 to 1 to set terminal A1 analog input to Multi-Step Speed 1.
- Set b1-01 to 0 when setting d1-01, Frequency Reference 1, to Multi-Step Speed 1.

• **Multi-Step Speed 2**

- Set H3-06, Terminal A3 Function Selection, to 2 (Auxiliary Frequency Reference 1) when setting terminal A3 analog input to Multi-Step Speed 2.
- Set H3-06 to F (Through mode) when setting d1-02, Frequency Reference 2, to Multi-Step Speed 2.

• **Multi-Step Speed 3**

- Set H3-10, Terminal A2 Function Selection, to 3 (Auxiliary Frequency Reference 2) when setting terminal A2 analog input to Multi-Step Speed 3.
- Set H3-10 to F (Through mode) when setting d1-03, Frequency Reference 3, to Multi-Step Speed 3.
- Set H3-09 to 0 and set jumper S1 on the control circuit terminal board to V (voltage) for A2 when inputting 0 to 10 V to terminal A2 analog input.

Select the different speed references as shown in *Table 4.13. Figure 4.17* illustrates the multi-step speed selection.

Table 4.13 Multi-Step Speed Reference and Terminal Switch Combinations

Reference	Multi-Step Speed 1 H1-□□ = 3	Multi-Step Speed 2 H1-□□ = 4	Multi-Step Speed 3 H1-□□ = 5	Multi-Step Speed 4 H1-□□ = 32	Jog Reference H1-□□ = 6
Frequency Reference 1 (set in b1-01)	OFF	OFF	OFF	OFF	OFF
Frequency Reference 2 (d1-02 or input terminal A1, A2, A3)	ON	OFF	OFF	OFF	OFF
Frequency Reference 3 (d1-03 or input terminal A1, A2, A3)	OFF	ON	OFF	OFF	OFF
Frequency Reference 4 (d1-04)	ON	ON	OFF	OFF	OFF
Frequency Reference 5 (d1-05)	OFF	OFF	ON	OFF	OFF
Frequency Reference 6 (d1-06)	ON	OFF	ON	OFF	OFF
Frequency Reference 7 (d1-07)	OFF	ON	ON	OFF	OFF
Frequency Reference 8 (d1-08)	ON	ON	ON	OFF	OFF
Frequency Reference 9 (d1-09)	OFF	OFF	OFF	ON	OFF
Frequency Reference 10 (d1-10)	ON	OFF	OFF	ON	OFF
Frequency Reference 11 (d1-11)	OFF	ON	OFF	ON	OFF
Frequency Reference 12 (d1-12)	ON	ON	OFF	ON	OFF
Frequency Reference 13 (d1-13)	OFF	OFF	ON	ON	OFF
Frequency Reference 14 (d1-14)	ON	OFF	ON	ON	OFF
Frequency Reference 15 (d1-15)	OFF	ON	ON	ON	OFF
Frequency Reference 16 (d1-16)	ON	ON	ON	ON	OFF
Jog Frequency Reference (d1-17) </>	–	–	–	–	ON

<1> The Jog frequency overrides all other frequency references.

4.6 Basic Drive Setup Adjustments

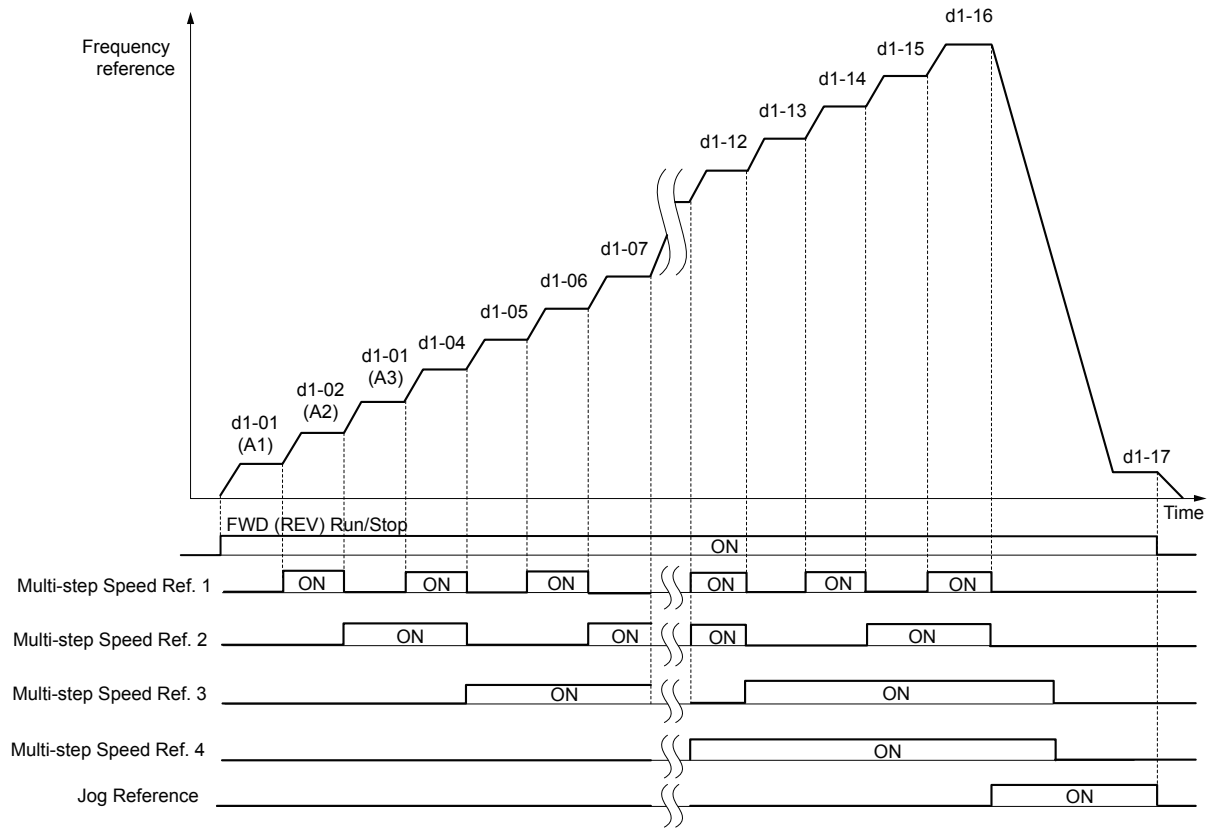

Figure 4.17 Preset Reference Timing Diagram

■ E1-01: Input Voltage Setting

Adjusts the levels of some protective features of the drive (overvoltage, Stall Prevention, etc.). Set this parameter to the nominal voltage of the AC power supply.

NOTICE: Set parameter E1-01 to match the input voltage of the drive. Drive input voltage (not motor voltage) must be set in E1-01 for the protective features to function properly. Failure to set the correct drive input voltage will result in improper drive operation.

No.	Parameter Name	Setting Range	Default
E1-01	Input Voltage Setting	155 to 255 V <1>	230 V <1>

<1> Values shown are specific to 200 V class drives. Double the value for 400 V class drives. Multiply the value by 2.875 for 600 V class drives.

E1-01 Related Values

The input voltage setting determines the overvoltage and undervoltage detection levels, the operation levels of the braking transistor, the KEB function, and the overvoltage suppression function.

Voltage	Setting Value of E1-01	ov Detection Level/Dynamic Braking Transistor Detection Level <1> (rr Detection Level)	(Approximate Values)		
			Uv Detection Level (L2-05)	Desired DC Bus Voltage during KEB (L2-11)	ov Suppression / Stall Prevention Level (L3-17)
200 V Class	All settings	410 V / 394 V	190 V	260 V	375 V
400 V Class	setting ≥ 400 V	820 V / 788 V	380 V	500 V	750 V
	setting < 400 V	820 V / 788 V	350 V	460 V	750 V
600 V Class	All settings	1178 V / 1132 V	475 V	635 V	930 V

<1> The braking transistor operation levels are valid for the drive internal braking transistor. When using a CDBR braking unit, refer to instruction manual TOBPC72060000 or TOBPC72060001.

■ V/f Pattern Settings (E1-03)

The drive uses a V/f pattern to adjust the output voltage relative to the frequency reference. There are 15 different predefined V/f patterns (setting 0 to E) from which to select, each with varying voltage profiles, saturation levels (frequency at which maximum voltage is reached), and maximum frequencies. Additionally, one custom V/f pattern is available (setting F) that requires the user to create the pattern using parameters E1-04 through E1-10.

■ E1-03: V/f Pattern Selection

Selects the V/f pattern for the drive and motor from 15 predefined patterns or creates a custom V/f pattern.

No.	Parameter Name	Setting Range	Default
E1-03	V/f Pattern Selection	0 to F	F </>

<1> Parameter is not reset to the default value when the drive is initialized using A1-03.

Setting a Predefined V/f Pattern (Setting 0 to E)

Choose the V/f pattern that best meets the application demands from [Table 4.14](#). These settings are available only in V/f Control modes. Set the correct value to E1-03. Parameters E1-04 to E1-13 can only be monitored, not changed.

- Note:**
1. Setting an improper V/f pattern may result in low motor torque or increased current due to overexcitation.
 2. Drive initialization does not reset parameter E1-03.

Table 4.14 Predefined V/f Patterns

Setting	Specification	Characteristic	Application
0	50 Hz	Constant torque	For general purpose applications. Torque remains constant regardless of changes to speed.
1	60 Hz		
2	60 Hz (with 50 Hz base)		
3	72 Hz (with 60 Hz base)		
4	50 Hz, Heavy Duty 2	Variable torque	For fans, pumps, and other applications where the required torque changes as a function of the speed.
5	50 Hz, Heavy Duty 1		
6	50 Hz, Heavy Duty 1		
7	50 Hz, Heavy Duty 2		
8	50 Hz, mid starting torque	High starting torque	Select high starting torque when: <ul style="list-style-type: none"> • Wiring between the drive and motor exceeds 150 m. • A large amount of starting torque is required. • An AC reactor is installed.
9	50 Hz, high starting torque		
A	60 Hz, mid starting torque		
B	60 Hz, high starting torque		
C	90 Hz (with 60 Hz base)	Constant output	Output voltage is constant when operating at greater than 60 Hz.
D	120 Hz (with 60 Hz base)		
E	180 Hz (with 60 Hz base)		
F </>	60 Hz	Constant torque	For general purpose applications. Torque remains constant regardless of changes to speed.

<1> Setting F enables a custom V/f pattern by changing parameters E1-04 to E1-13. When the drive is shipped, the default values for parameters E1-04 to E1-13 are the same as those of setting 1.

The following tables show details on predefined V/f patterns.

Predefined V/f Patterns for Models 2A0004 to 2A0021, 4A0002 to 4A0011, and 5A0003 to 5A0009

The values in the following graphs are specific to 200 V class drives. Double the values for 400 V class drives. Multiply the values by 2.875 for 600 V drives.

Table 4.15 Constant Torque Characteristics, Settings 0 to 3

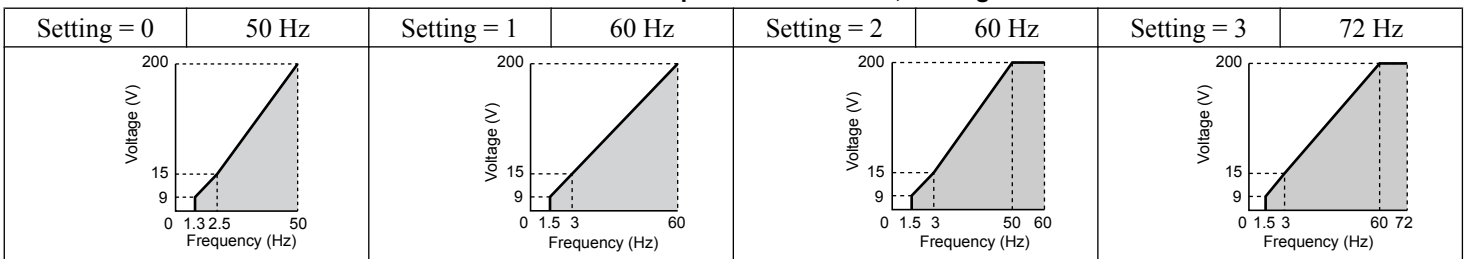

4.6 Basic Drive Setup Adjustments

Table 4.16 Derated Torque Characteristics, Settings 4 to 7

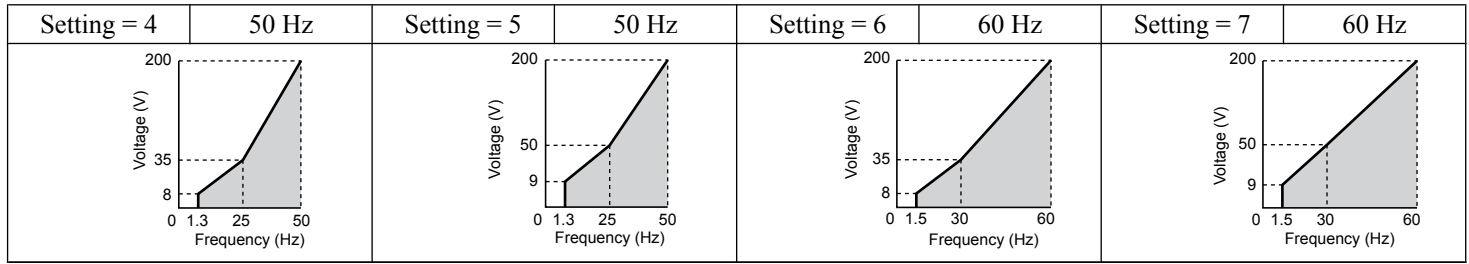

Table 4.17 High Starting Torque, Settings 8 to B

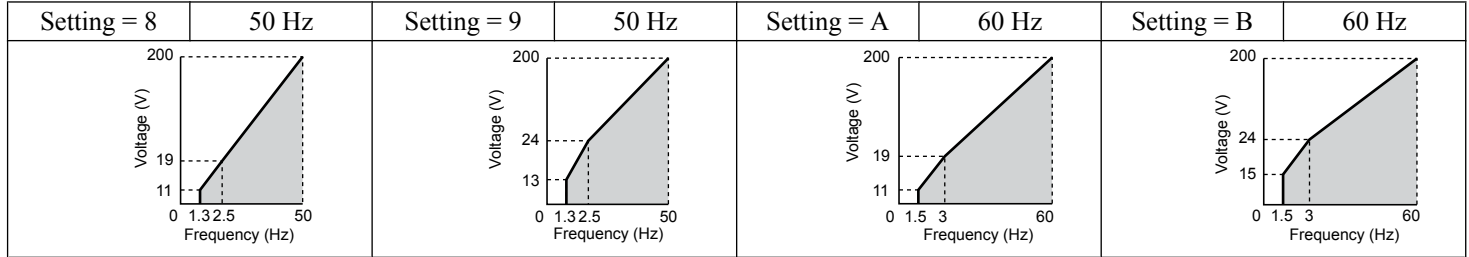
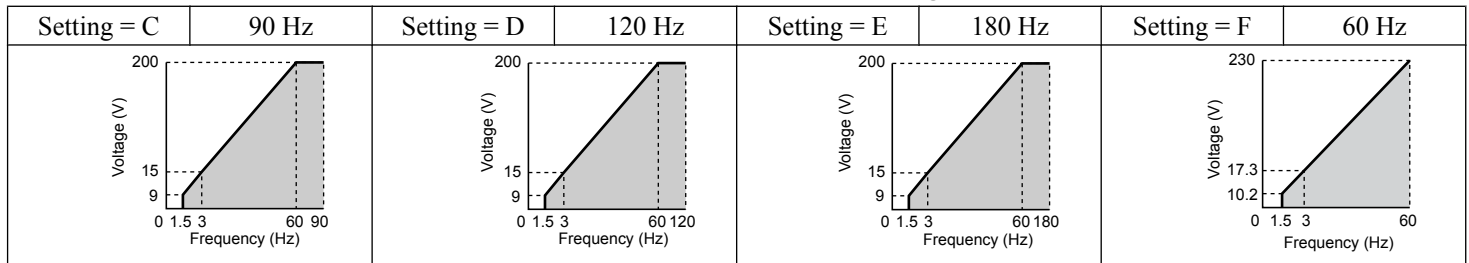

Table 4.18 Rated Output Operation, Settings C to F



Predefined V/f Patterns for Models 2A0030 to 2A0211, 4A0018 to 4A0103, and 5A0011 to 5A0077

The values in the following graphs are specific to 200 V class drives. Double the values for 400 V class drives. Multiply the values by 2.875 for 600 V class drives.

Table 4.19 Rated Torque Characteristics, Settings 0 to 3

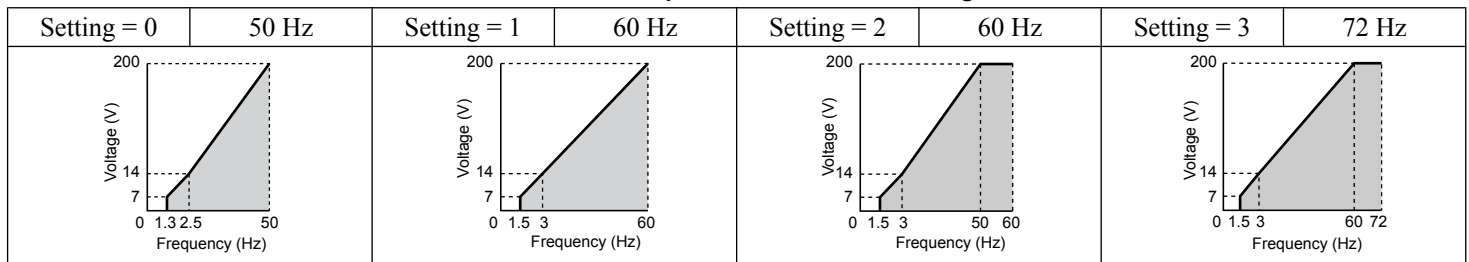

Table 4.20 Derated Torque Characteristics, Settings 4 to 7

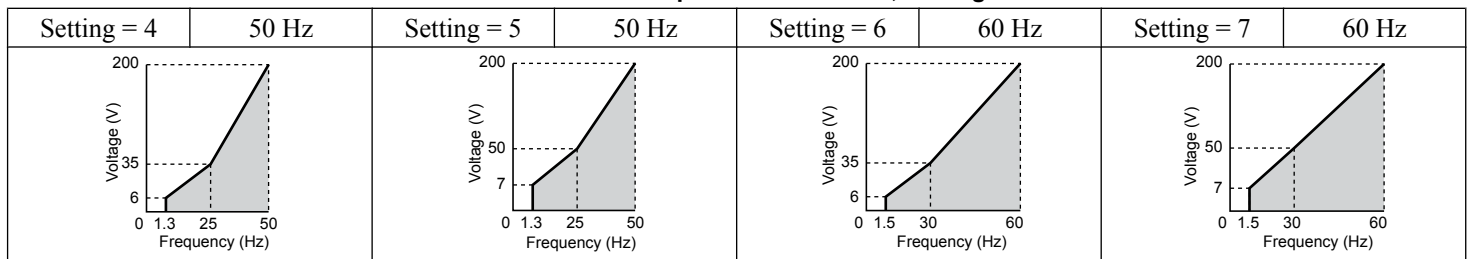

Table 4.21 High Starting Torque, Settings 8 to B

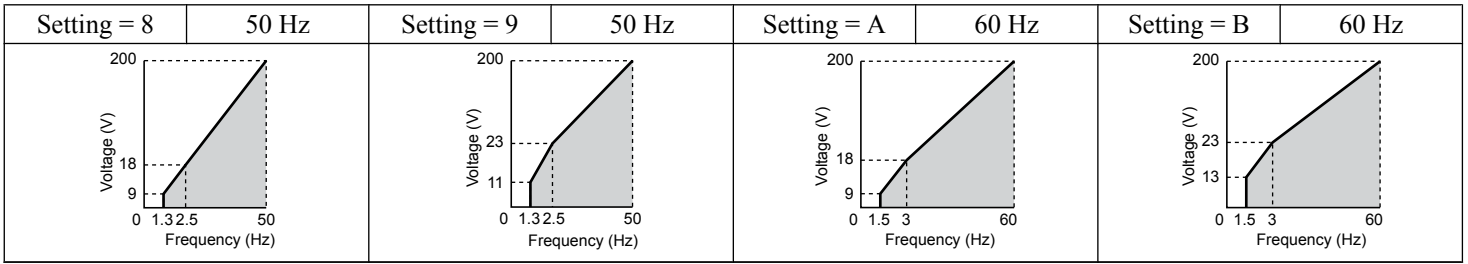
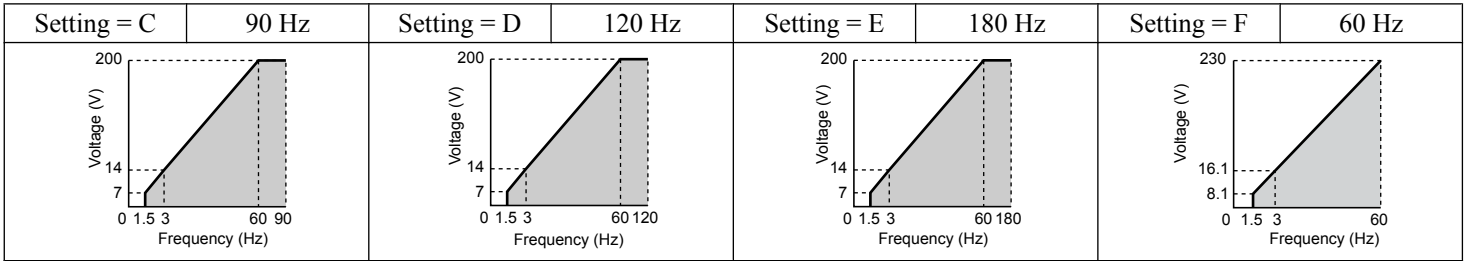

Table 4.22 Constant Output, Settings C to F



Predefined V/f Patterns for Models 2A0250 to 2A0415, 4A0139 to 4A0675, and 5A0099 to 5A0242

The values in the following graphs are specific to 200 V class drives. Double the values for 400 V class drives. Multiply the values by 2.875 for 600 V class drives.

Table 4.23 Rated Torque Characteristics, Settings 0 to 3

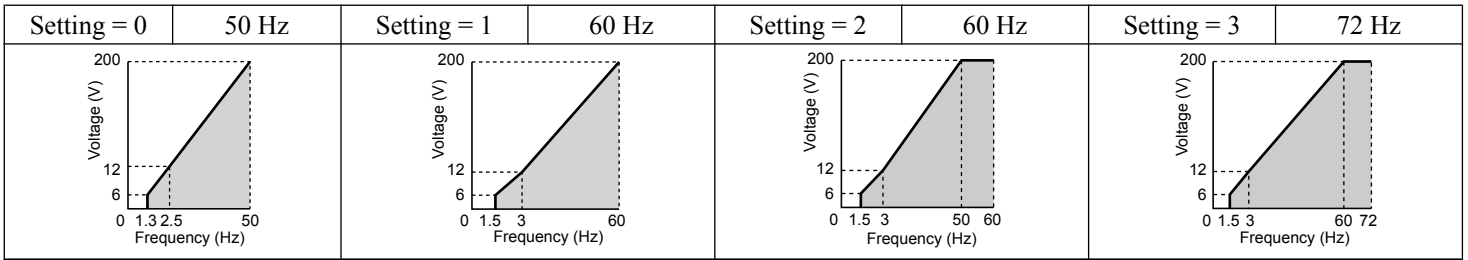

Table 4.24 Derated Torque Characteristics, Settings 4 to 7

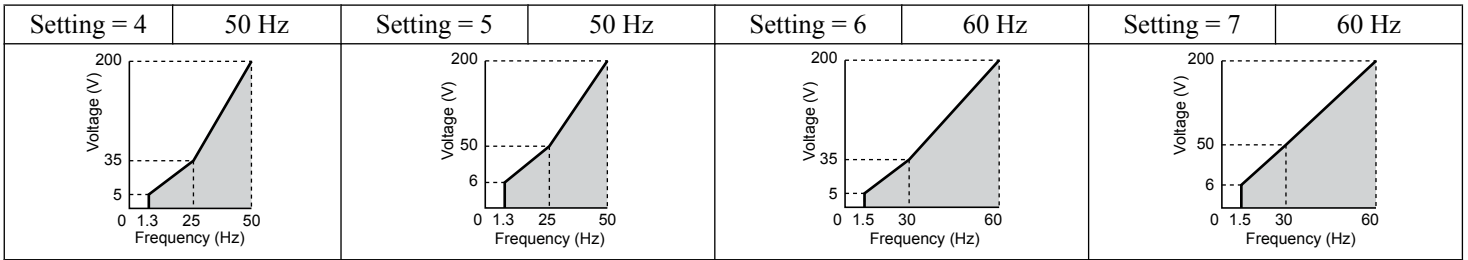
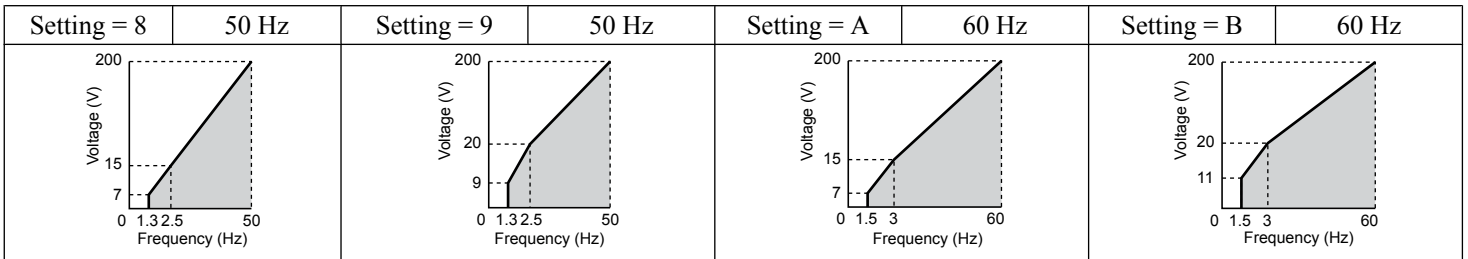
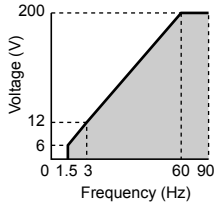
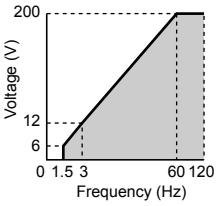
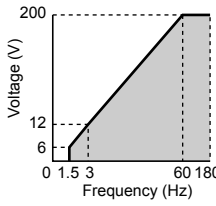
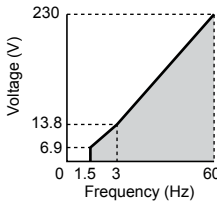

Table 4.25 High Starting Torque, Settings 8 to B



4.6 Basic Drive Setup Adjustments

Table 4.26 Constant Output, Settings C to F

Setting = C	90 Hz	Setting = D	120 Hz	Setting = E	180 Hz	Setting = F	60 Hz
							

Setting a Custom V/f Pattern (Setting F: Default)

Setting parameter E1-03 to F allows the user to set up a custom V/f pattern by changing parameters E1-04 to E1-13.

When initialized, the default values for parameters E1-04 to E1-13 will be equal to Predefined V/f pattern 1.

■ V/f Pattern Settings E1-04 to E1-13

If E1-03 is set to a preset V/f pattern (i.e., a value other than F), the user can monitor the V/f pattern in parameters E1-04 through E1-13. To create a new V/f pattern, set E1-03 to F. [Refer to V/f Pattern on page 100](#) for an example custom V/f pattern.

No.	Parameter Name	Setting Range	Default
E1-04	Maximum Output Frequency	40.0 to 400.0 Hz	60.0 Hz
E1-05	Maximum Voltage	0.0 to 255.0 V <4>	575.0 V
E1-06	Base Frequency	0.0 to [E1-04]	60.0 Hz
E1-07	Middle Output Frequency	0.0 to [E1-04]	3.0 Hz
E1-08	Middle Output Frequency Voltage	0.0 to 255.0 V <4>	15.0 V
E1-09	Minimum Output Frequency	0.0 to [E1-04]	1.5 Hz
E1-10	Minimum Output Frequency Voltage	0.0 to 255.0 V <4>	9.0 V
E1-11	Middle Output Frequency 2	0.0 to [E1-04]	0.0 Hz <6>
E1-12	Middle Output Frequency Voltage 2	0.0 to 255.0 V <4>	0.0 V <5> <6>
E1-13	Base Voltage	0.0 to 255.0 V <4>	0.0 V <5> <7>

<4> Values shown are specific to 200 V class drives. Double the value for 400 V class drives. Multiply the value by 2.875 for 600 V class drives.

<5> The drive changes these settings when Auto-Tuning is performed (Rotational Auto-Tuning, Stationary Auto-Tuning 1, 2).

<6> Parameter ignored when E1-11 and E1-12 are set to 0.0.

<7> E1-13 and E1-05 are set to the same value when Auto-Tuning is performed.

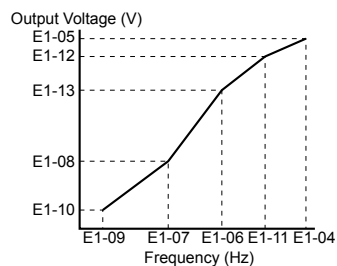

Figure 4.18 V/f Pattern

- Note:**
1. The following condition must be true when setting up the V/f pattern: $E1-09 \leq E1-07 < E1-06 \leq E1-11 \leq E1-04$
 2. To make the V/f pattern a straight line below E1-06, set E1-09 equal to E1-07. In this case the E1-08 setting is disregarded.
 3. E1-03 is unaffected when the drive is initialized, but E1-04 through E1-13 return to their default values.
 4. Only use E1-11, E1-12, and E1-13 to fine-tune the V/f pattern in the constant output range. These parameters rarely need to be changed.

■ E2-01: Motor Rated Current

Provides motor control, protects the motor, and calculates torque limits. Set E2-01 to the full load amps (FLA) stamped on the motor nameplate. If Auto-Tuning completes successfully, the value entered to T1-04 will automatically be saved to E2-01.

No.	Parameter Name	Setting Range	Default
E2-01	Motor Rated Current	10% to 200% of the drive rated current	Determined by o2-04

- Note:**
1. The number of decimal places in the parameter value depends on the drive model. This value has two decimal places (0.01 A) if the drive is set for a maximum applicable motor capacity up to and including 11 kW, and one decimal place (0.1 A) if the maximum applicable motor capacity is higher than 11 kW. *Refer to Power Ratings on page 164* for details.
 2. An oPE02 error will occur if the motor rated current in E2-01 is set lower than the motor no-load current in E2-03. Set E2-03 correctly to prevent this error.

■ **H1-01 to H1-08: Functions for Terminals S1 to S8**

These parameters assign functions to the multi-function digital inputs. The various functions and settings are listed in [Table 4.27](#).

No.	Parameter Name	Setting Range	Default
H1-01	Multi-Function Digital Input Terminal S1 Function Selection	1 to 9F	40 (F) <1> : Forward Run Command (2-Wire sequence)
H1-02	Multi-Function Digital Input Terminal S2 Function Selection	1 to 9F	41 (F) <1> : Reverse Run Command (2-Wire sequence)
H1-03	Multi-Function Digital Input Terminal S3 Function Selection	0 to 9F	24: External Fault
H1-04	Multi-Function Digital Input Terminal S4 Function Selection	0 to 9F	14: Fault Reset
H1-05	Multi-Function Digital Input Terminal S5 Function Selection	0 to 9F	3 (0) <1> : Multi-Step Speed Reference 1
H1-06	Multi-Function Digital Input Terminal S6 Function Selection	0 to 9F	4 (3) <1> : Multi-Step Speed Reference 2
H1-07	Multi-Function Digital Input Terminal S7 Function Selection	0 to 9F	6 (4) <1> : Jog Reference Selection
H1-08	Multi-Function Digital Input Terminal S8 Function Selection	0 to 9F	8: (6) <1> : External Baseblock Command

<1> Number appearing in parenthesis is the default value after performing a 3-Wire initialization (A1-03 = 3330).

Table 4.27 Multi-Function Digital Input Terminal Settings

Setting	Function	Page	Setting	Function	Page
0	3-Wire Sequence	102	30	PID Integral Reset	—
1	LOCAL/REMOTE Selection	—	31	PID Integral Hold	—
2	External Reference 1/2 Selection	—	32	Multi-Step Speed Reference 4	—
3	Multi-Step Speed Reference 1	—	34	PID Soft Starter Cancel	—
4	Multi-Step Speed Reference 2		35	PID Input Level Selection	—
5	Multi-Step Speed Reference 3		40	Forward Run Command (2-Wire sequence)	—
6	Jog reference Selection	41	Reverse Run Command (2-Wire sequence)		
7	Accel/Decel Time Selection 1	—	42	Run Command (2-Wire sequence 2)	—
8	Baseblock Command (N.O.)	—	43	FWD/REV Command (2-Wire sequence 2)	
9	Baseblock Command (N.C.)		47	Node Setup	—
A	Accel/Decel Ramp Hold	—	51	Disable Sequence Timers	—
B	Drive Overheat Alarm (oH2)	—	52	Cancel Active Sequence Timer	—
C	Analog Terminal Input Selection	—	60	DC Injection Braking Command	—
F	Through Mode	—	61	External Speed Search Command 1	—
10	Up Command	—	62	External Speed Search Command 2	—
11	Down Command		63	Field Weakening	—
12	Forward Jog	—	65	KEB Ride-Thru 1 (N.C.)	—
13	Reverse Jog		66	KEB Ride-Thru 1 (N.O.)	
14	Fault Reset	—	67	Communications Test Mode	—
15	Fast Stop (N.O.)	—	68	High Slip Braking (HSB)	—
17	Fast Stop (N.C.)	—	6A	Drive Enabled	—
18	Timer Function Input	—	75	Up 2 Command	—
19	PID Disable	—	76	Down 2 Command	
1A	Accel/Decel Time Selection 2	—	7A	KEB Ride-Thru 2 (N.C.)	—
1B	Program Lockout	—	7B	KEB Ride-Thru 2 (N.O.)	
1E	Reference Sample Hold	—	A8	Secondary PI Disable (N.O.)	—
20 to 2F	External Fault	—	A9	Secondary PI Disable (N.C.)	—

4.6 Basic Drive Setup Adjustments

Setting	Function	Page	Setting	Function	Page
AA	Secondary PI Inverse Operation	—	AD	Select Secondary PI Parameters	—
AB	Secondary PI Integral Reset	—	AF	Emergency Override Forward Run	—
AC	Secondary PI Integral Hold	—	B0	Emergency Override Reverse Run	—

Setting 0: 3-Wire Sequence

The digital input programmed for 3-Wire control becomes the forward/reverse directional input, S1 becomes the Run command input, and S2 becomes the Stop command input.

The drive starts the motor when the input S1 set for the Run command closes for longer than 2 ms. The drive stops the operation when the Stop input S2 releases for 2 ms. When the digital input programmed for a forward/reverse operation is open, the drive is set for forward operation. When the digital input is closed, the drive is set for reverse operation.

Note: Input the Run and Stop commands via S1 and S2 when selecting a 3-Wire sequence.

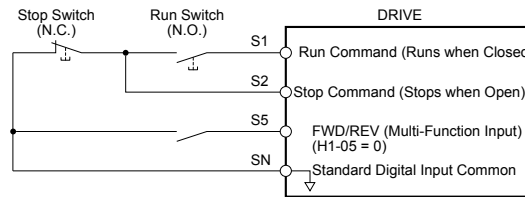

Figure 4.19 3-Wire Sequence Wiring Diagram

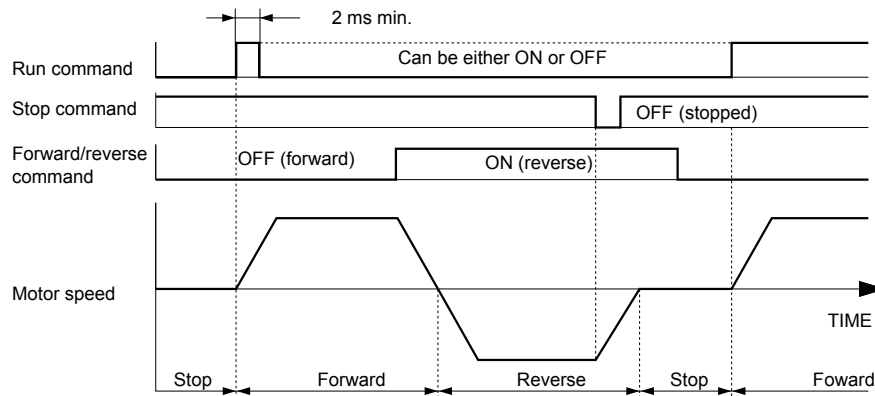

Figure 4.20 3-Wire Sequence

- Note:**
1. The Run command must be closed for more than 2 ms.
 2. If the Run command is active at power up and b1-17 = 0 (Run command at power up not accepted), the Run LED will flash to indicate that protective functions are operating. If required by the application, set b1-17 to 1 to automatically issue the Run command upon drive power up.

WARNING! Sudden Movement Hazard. Ensure start/stop and safety circuits are wired properly and in the correct state before applying power to the drive. Failure to comply could result in death or serious injury from moving equipment.

WARNING! Sudden Movement Hazard. The drive may start unexpectedly in reverse direction after power up if it is wired for 3-Wire sequence but set up for 2-Wire sequence (default). Make sure b1-17 is set to "0" (drive does not accept a Run command active at power up). When initializing the drive use 3-Wire initialization. Failure to comply could result in death or serious injury from moving equipment.

■ H2-01 to H2-03: Terminal M1-M2, M3-M4, and MD-ME-MF Function Selection

The drive has three multi-function output terminals. [Table 4.28](#) lists the functions available for these terminals using H2-01, H2-02, and H2-03.

No.	Parameter Name	Setting Range	Default
H2-01	Terminal M1-M2 Function Selection (relay)	0 to 192	0: During Run
H2-02	Terminal M3-M4 Function Selection (relay)	0 to 192	1: Zero Speed
H2-03	Terminal MD-ME-MF Function Selection (relay)	0 to 192	2: Speed agree 1

Table 4.28 Multi-Function Digital Output Terminal Settings

Setting	Function	Setting	Function
0	During Run	1	Zero Speed

Setting	Function	
2	Speed Agree 1	— 103
3	User-Set Speed Agree 1	— 104
4	Frequency Detection 1	—
5	Frequency Detection 2	—
6	Drive Ready	—
7	DC Bus Undervoltage	—
8	During Baseblock (N.O.)	—
9	Frequency Reference Source	—
A	Run Command Source	—
B	Torque Detection 1 (N.O.)	—
C	Frequency Reference Loss	—
D	Braking Resistor Fault	—
E	Fault	—
F	Through Mode	—
10	Minor Fault	—
11	Fault Reset Command Active	—
12	Timer Output	—
13	Speed Agree 2	—
14	User-Set Speed Agree 2	—
15	Frequency Detection 3	—
16	Frequency Detection 4	—
17	Torque Detection 1 (N.C.)	—
18	Torque Detection 2 (N.O.)	—
19	Torque Detection 2 (N.C.)	—
1A	During Reverse	—
1B	During Baseblock (N.C.)	—
1E	Restart Enabled	—

Setting	Function	
1F	Motor Overload Alarm (oL1)	—
20	Drive Overheat Pre-Alarm (oH)	—
22	Mechanical Weakening Detection	—
2F	Maintenance Period	—
37	During Frequency Output	—
38	Drive Enabled	—
39	Watt Hour Pulse Output	—
3C	LOCAL/REMOTE Status	—
3D	During Speed Search	—
3E	PID Feedback Low	—
3F	PID Feedback High	—
4A	During KEB Operation	—
4C	During Fast Stop	—
4D	oH Pre-Alarm Time Limit	—
4E <2>	Braking Transistor Fault (rr)	—
4F <2>	Braking Resistor Overheat (rH)	—
50	Waiting to Run	—
51	Sequence timer 1	—
52	Sequence timer 2	—
53	Sequence timer 3	—
54	Sequence timer 4	—
58	UL6 Detected	—
60	Internal Cooling Fan Alarm	—
71	Secondary PI Feedback Low	—
72	Secondary PI Feedback High	—
100 to 192	Functions 0 to 92 with Inverse Output	—

<2> Not available in models 2A0169 to 2A0415 and 4A0088 to 4A0675.

Setting 2: Speed Agree 1 (f_{ref}/f_{out} Agree 1)

Closes when the actual output frequency is within the Speed Agree Width (L4-02) of the current frequency reference regardless of the direction.

Status	Description
Open	Output frequency or motor speed does not match the frequency reference while the drive is running.
Closed	Output frequency or motor speed is within the range of frequency reference ±L4-02.

Note: Detection works in forward and reverse.

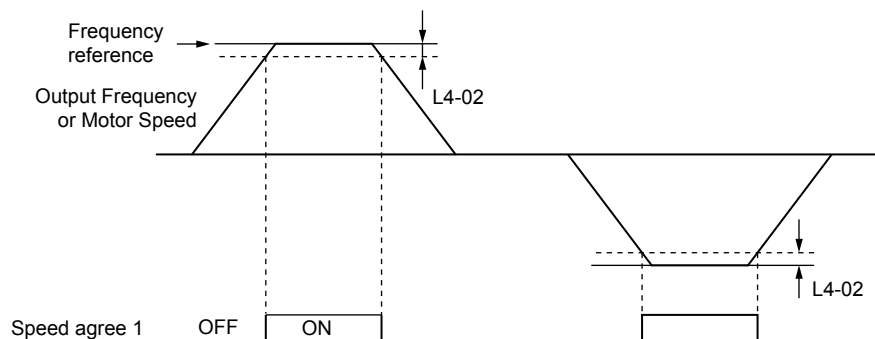

Figure 4.21 Speed Agree 1 Time Chart

4.6 Basic Drive Setup Adjustments

Setting 3: User-Set Speed Agree 1 (f_{ref}/f_{set} Agree 1)

Closes when the actual output frequency and the frequency reference are within the speed agree width (L4-02) of the programmed speed agree level (L4-01).

Status	Description
Open	Output frequency or motor speed and frequency reference are not both within the range of L4-01 \pm L4-02.
Closed	Output frequency or motor speed and the frequency reference are both within the range of L4-01 \pm L4-02.

Note: Frequency detection works in forward and reverse. The value of L4-01 is used as the detection level for both directions.

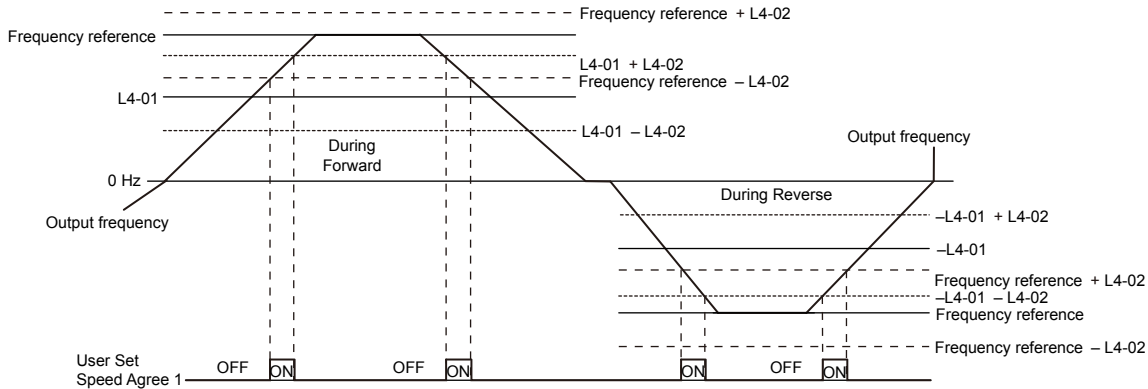

Figure 4.22 User Set Speed Agree 1 Time Chart

■ H3-01: Terminal A1 Signal Level Selection

Selects the input signal level for analog input A1.

No.	Name	Setting Range	Default
H3-01	Terminal A1 Signal Level Selection	0 to 3	0

Setting 0: 0 to 10 Vdc

The input level is 0 to 10 Vdc. The minimum input level is limited to 0%, so that a negative input signal due to gain and bias settings will be read as 0%.

Setting 1: -10 to 10 Vdc

The input level is -10 to 10 Vdc. If the resulting voltage is negative after being adjusted by gain and bias settings, then the motor will rotate in reverse.

Setting 2: 4 to 20 mA

Setting 3: 0 to 20 mA

■ H3-02: Terminal A1 Function Selection

Selects the input signal level for analog input A3.

No.	Name	Setting Range	Default
H3-02	Terminal A1 Function Selection	0 to 32	0

■ H3-03, H3-04: Terminal A1 Gain and Bias Settings

Parameter H3-03 sets the level of the selected input value that is equal to 10 Vdc input at terminal A1 (gain).

Parameter H3-04 sets the level of the selected input value that is equal to 0 V input at terminal A1 (bias).

Use both parameters to adjust the characteristics of the analog input signal to terminal A1.

No.	Name	Setting Range	Default
H3-03	Terminal A1 Gain Setting	-999.9 to 999.9%	100.0%
H3-04	Terminal A1 Bias Setting	-999.9 to 999.9%	0.0%

Setting Examples

- Gain H3-03 = 200%, bias H3-04 = 0, terminal A1 as frequency reference input (H3-02 = 0):

A 10 Vdc input is equivalent to a 200% frequency reference and 5 Vdc is equivalent to a 100% frequency reference. Since the drive output is limited by the maximum frequency parameter (E1-04), the frequency reference will be equal to E1-04 above 5 Vdc.

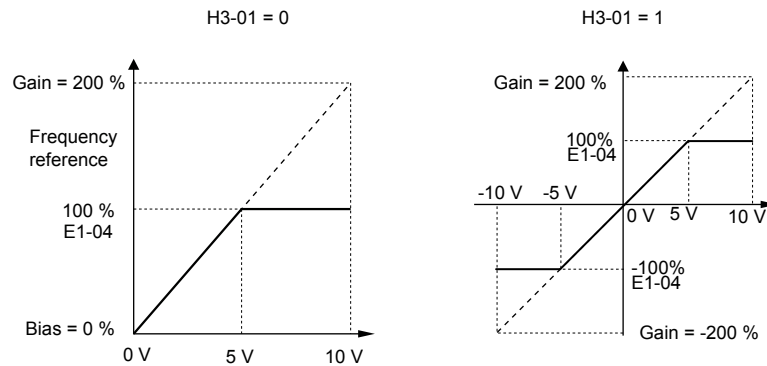

Figure 4.23 Frequency Reference Setting by Analog Input with Increased Gain

- Gain H3-03 = 100%, bias H3-04 = -25%, terminal A1 as frequency reference input:
 An input of 0 Vdc will be equivalent to a -25% frequency reference.
 When parameter H3-01 = 0, the frequency reference is 0% between 0 and 2 Vdc input.
 When parameter H3-01 = 1, the motor will rotate in reverse between -10 and 2 Vdc input.

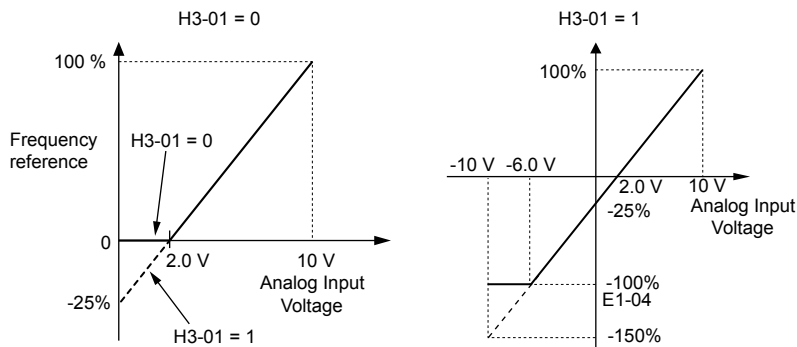

Figure 4.24 Frequency Reference Setting by Analog Input with Negative Bias

■ H3-05: Terminal A3 Signal Level Selection

Determines the function assigned to analog input terminal A3.

No.	Name	Setting Range	Default
H3-05	Terminal A3 Signal Level Selection	0 to 3	0

Setting 0: 0 to 10 Vdc

The input level is 0 to 10 Vdc. See the explanation provided for H3-01. *Refer to Setting 0: 0 to 10 Vdc on page 104.*

Setting 1: -10 to 10 Vdc

The input level is -10 to 10 Vdc. See the explanation provided for H3-01. *Refer to Setting 1: -10 to 10 Vdc on page 104.*

Setting 2: 4 to 20 mA

Setting 3: 0 to 20 mA

■ H3-06: Terminal A3 Function Selection

Determines the function assigned to analog input terminal A3.

No.	Name	Setting Range	Default
H3-06	Terminal A3 Function Selection	0 to 31	2

■ H3-07, H3-08: Terminal A3 Gain and Bias Setting

Parameter H3-07 sets the level of the selected input value that is equal to 10 Vdc input at terminal A3 (gain).

4.6 Basic Drive Setup Adjustments

Parameter H3-08 sets the level of the selected input value that is equal to 0 V input at terminal A3 (bias).

No.	Name	Setting Range	Default
H3-07	Terminal A3 Gain Setting	-999.9 to 999.9%	100.0%
H3-08	Terminal A3 Bias Setting	-999.9 to 999.9%	0.0%

■ H3-09: Terminal A2 Signal Level Selection

Selects the input signal level for analog input A2. Set DIP switch S1 on the terminal board accordingly for a voltage input or current input.

No.	Name	Setting Range	Default
H3-09	Terminal A2 Signal Level Selection	0 to 3	2

Setting 0: 0 to 10 Vdc

The input level is 0 to 10 Vdc. *Refer to Setting 0: 0 to 10 Vdc on page 104.*

Setting 1: -10 to 10 Vdc

The input level is -10 to 10 Vdc. *Refer to Setting 1: -10 to 10 Vdc on page 104.*

Setting 2: 4 to 20 mA

The input level is 4 to 20 mA. Negative input values by negative bias or gain settings will be limited to 0%.

Setting 3: 0 to 20 mA

The input level is 0 to 20 mA. Negative input values by negative bias or gain settings will be limited to 0%.

■ H3-10: Terminal A2 Function Selection

Determines the function assigned to analog input terminal A2.

No.	Name	Setting Range	Default
H3-10	Terminal A2 Function Selection	0 to 32	0

■ H3-11, H3-12: Terminal A2 Gain and Bias Setting

Parameter H3-11 sets the level of the input value selected that is equal to 10 Vdc input or 20 mA input to terminal A2.

Parameter H3-12 sets the level of the input value selected that is equal to 0 V, 4 mA or 0 mA input at terminal A2.

Use both parameters to adjust the characteristics of the analog input signal to terminal A2. The setting works in the same way as parameters H3-03 and H3-04 for analog input A1.

No.	Name	Setting Range	Default
H3-11	Terminal A2 Gain Setting	-999.9 to 999.9%	100.0%
H3-12	Terminal A2 Bias Setting	-999.9 to 999.9%	0.0%

■ H4-01, H4-04: Multi-Function Analog Output Terminal FM, AM Monitor Selection

Sets the desired drive monitor parameter U□-□□ to output as an analog value via terminal FM and AM. *Refer to U1: Operation Status Monitors on page 222* for a list of all monitors. The “Analog Output Level” column indicates whether a monitor can be used for analog output.

Example: Enter “103” for U1-03.

No.	Name	Setting Range	Default
H4-01	Multi-Function Analog Output Terminal FM Monitor Selection	000 to 999	102
H4-04	Multi-Function Analog Output Terminal AM Monitor Selection	000 to 999	103

A setting of 031 or 000 applies no drive monitor to the analog output. With this setting, terminal functions as well as FM and AM output levels can be set by a PLC via a communication option or MEMOBUS/Modbus (through mode).

■ H4-02, H4-03: Multi-Function Analog Output Terminal FM Gain and Bias H4-05, H4-06: Multi-Function Analog Output Terminal AM Gain and Bias

Parameters H4-02 and H4-05 set the terminal FM and AM output signal level when the value of the selected monitor is at 100%. Parameters H4-03 and H4-06 set the terminal FM and AM output signal level when the value of the selected monitor is at 0%. Both are set as a percentage, where 100% equals 10 Vdc or 20 mA analog output and 0% equals 0 V or 4 mA. The output voltage of both terminals is limited to +/-10 Vdc.

The output signal range can be selected between 0 to +10 Vdc or -10 to +10 Vdc, or 4 to 20 mA using parameter H4-07 and H4-08. *Figure 4.25* illustrates how gain and bias settings work.

No.	Name	Setting Range	Default
H4-02	Multi-Function Analog Output Terminal FM Gain	-999.9 to 999.9%	100.0%
H4-03	Multi-Function Analog Output Terminal FM Bias	-999.9 to 999.9%	0.0%
H4-05	Multi-Function Analog Output Terminal AM Gain	-999.9 to 999.9%	50.0%
H4-06	Multi-Function Analog Output Terminal AM Bias	-999.9 to 999.9%	0.0%

Using Gain and Bias to Adjust Output Signal Level

The output signal is adjustable while the drive is stopped.

Terminal FM

1. View the value set to H4-02 (Terminal FM Monitor Gain) on the digital operator. A voltage equal to 100% of the parameter being set in H4-01 will be output from terminal FM.
2. Adjust H4-02 viewing the monitor connected to the terminal FM.
3. View the value set to H4-03 on the digital operator; terminal FM will output a voltage equal to 0% of the parameter being set in H4-01.
4. Adjust H4-03 viewing the output signal on the terminal FM.

Terminal AM

1. View the value set to H4-05 (Terminal AM Monitor Gain) on the digital operator. A voltage equal to 100% of the parameter being set in H4-04 will be output from terminal AM.
2. Adjust H4-05 viewing the monitor connected to the terminal AM.
3. View the value set to H4-06 on the digital operator; terminal AM will output a voltage equal to 0% of the parameter being set in H4-04.
4. Adjust H4-06 viewing the output signal on the terminal AM.

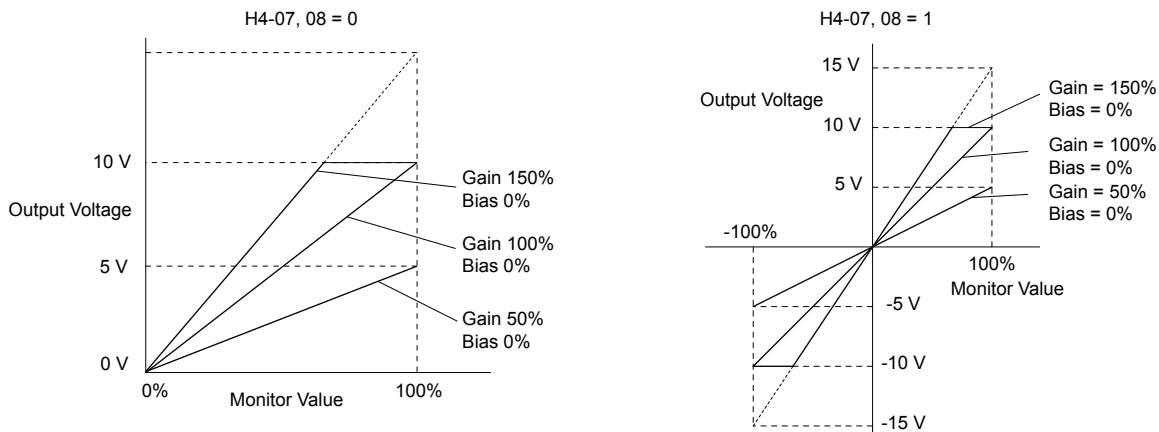

Figure 4.25 Analog Output Gain and Bias Setting Example 1 and 2

Set H4-03 to 30% for an output signal of 3 V at terminal FM when the monitored value is at 0%.

4.6 Basic Drive Setup Adjustments

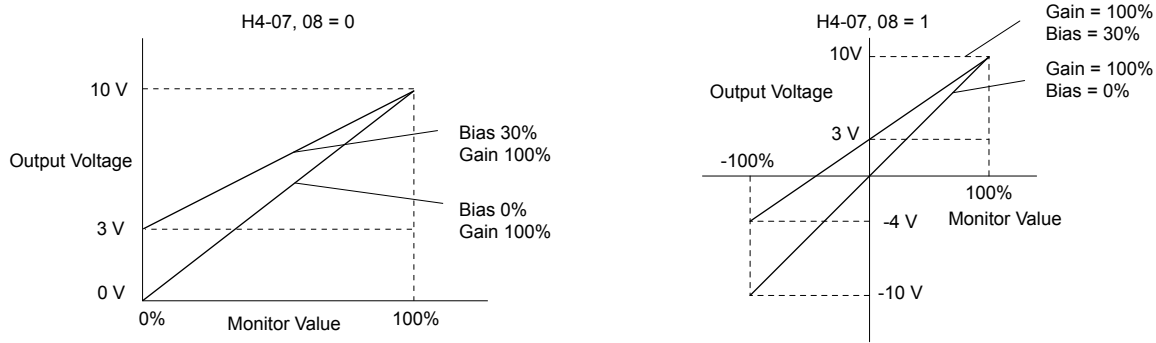

Figure 4.26 Analog Output Gain and Bias Setting Example 3

■ H4-07, H4-08: Multi-Function Analog Output Terminal FM, AM Signal Level Selection

Sets the voltage output level of U parameter (monitor parameter) data to terminal FM and terminal AM using parameters H4-07 and H4-08.

No.	Name	Setting Range	Default
H4-07	Multi-Function Analog Output Terminal FM Signal Level Selection	0 to 2	0
H4-08	Multi-Function Analog Output Terminal AM Signal Level Selection	0 to 2	0

Setting 0: 0 to 10 V

Setting 1: -10 V to 10 V

Setting 2: 4 to 20 mA

■ L3-01: Stall Prevention Selection during Acceleration

Stall Prevention during acceleration prevents tripping with overcurrent (oC), motor overload (oL1), or drive overload (oL2) faults common when accelerating with heavy loads.

L3-01 determines the type of Stall prevention the drive should use during acceleration.

No.	Name	Setting Range	Default
L3-01	Stall Prevention Selection during Acceleration	0 to 2	1

Setting 0: Disabled

No Stall Prevention is provided. If the acceleration time is too short, the drive may not be able to get the motor up to speed fast enough, causing an overload fault.

Setting 1: Enabled

Enables Stall Prevention during acceleration.

Acceleration is reduced when the output current value exceeds 85% of the level set to parameter L3-02 for a longer than the time set to L3-27. The acceleration stops when the current exceeds L3-02. Acceleration continues when the current falls below L3-02 for longer than the time set to L3-27.

The Stall Prevention level is automatically reduced in the constant power range. [Refer to L3-03: Stall Prevention Limit during Acceleration on page 109.](#)

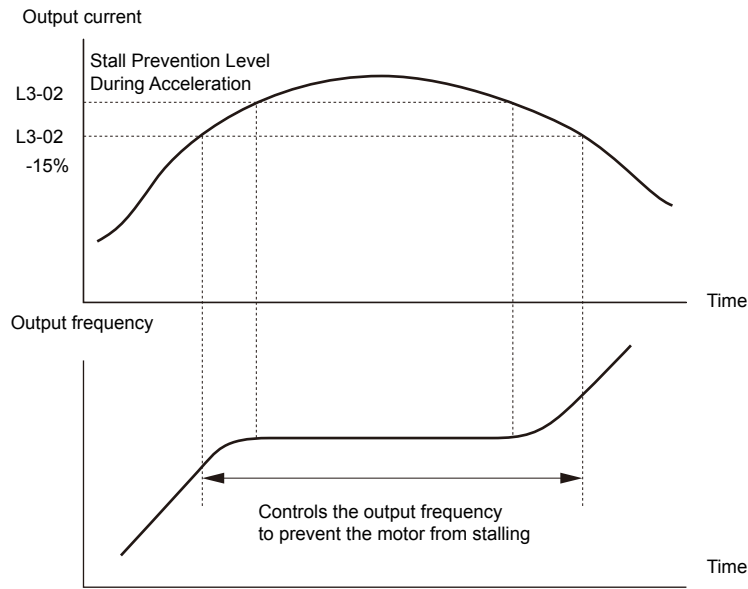

Figure 4.27 Stall Prevention During Acceleration for Induction Motors

Setting 2: Intelligent Stall Prevention

The drive disregards the selected acceleration time and attempts to accelerate in the minimum time. The acceleration rate is adjusted so the current does not exceed the value set to parameter L3-02.

■ L3-02: Stall Prevention Level during Acceleration

Sets the output current level at which the Stall Prevention during acceleration is activated.

No.	Name	Setting Range	Default
L3-02	Stall Prevention Level during Acceleration	0 to 150% </>	</>

<1> The upper limit and default value is determined by parameter L8-38, Carrier Frequency Reduction.

- Lower L3-02 if stalling occurs when using a motor that is relatively small compared to the drive.
- Also set parameter L3-03 when operating the motor in the constant power range.

■ L3-03: Stall Prevention Limit during Acceleration

The Stall Prevention level is automatically reduced when the motor is operated in the constant power range. L3-03 sets the lower limit for this reduction as a percentage of the drive rated current.

No.	Name	Setting Range	Default
L3-03	Stall Prevention Limit during Acceleration	0 to 100%	50%

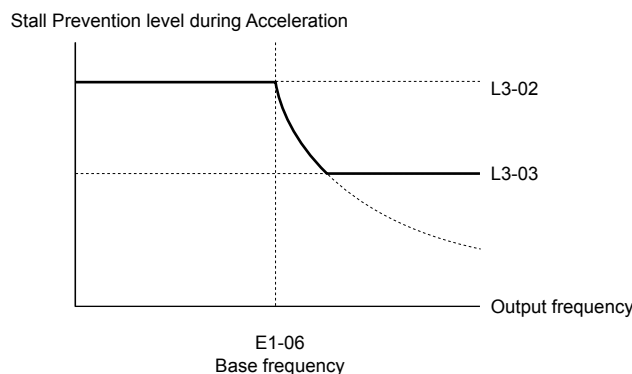

Figure 4.28 Stall Prevention Level and Limit During Acceleration

4.6 Basic Drive Setup Adjustments

■ L3-04: Stall Prevention Selection during Deceleration

Stall Prevention during deceleration controls the deceleration based on the DC bus voltage and prevents an overvoltage fault caused by high inertia or rapid deceleration.

No.	Name	Setting Range	Default
L3-04	Stall Prevention Selection During Deceleration	0 to 5	1

Setting 0: Disabled

The drive decelerates according to the set deceleration time. With high inertia loads or rapid deceleration, an overvoltage fault may occur. If an overvoltage fault occurs, use dynamic braking options or switch to another L3-04 selection.

Setting 1: General-purpose Stall Prevention

The drive tries to decelerate within the set deceleration time. The drive pauses deceleration when the DC bus voltage exceeds the Stall Prevention level and then continues deceleration when the DC bus voltage drops below that level. Stall Prevention may be triggered repeatedly to avoid an overvoltage fault. The DC bus voltage level for Stall Prevention depends on the input voltage setting E1-01.

Drive Input Voltage	Stall Prevention Level during Deceleration
200 V Class	377 Vdc
400 V Class	754 Vdc
600 V Class	1084 Vdc

- Note:**
1. Do not use this setting in combination with a Dynamic Braking Resistor or other dynamic braking options. If Stall Prevention during deceleration is enabled, it will be triggered before the braking resistor option can operate.
 2. This method may lengthen the total deceleration time compared to the set value. If this is not appropriate for the application consider using a dynamic braking option.

Figure 4.29 illustrates the function of Stall Prevention during deceleration.

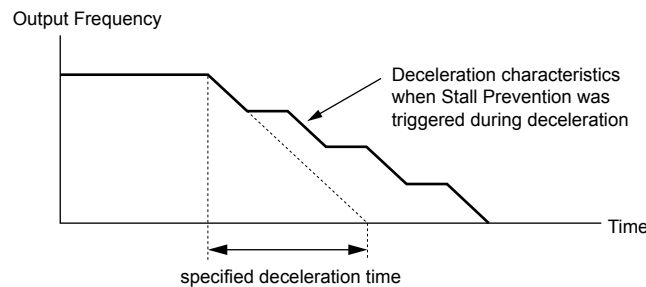

Figure 4.29 Stall Prevention During Deceleration

Setting 2: Intelligent Stall Prevention

The drive adjusts the deceleration rate so the DC bus voltage is kept at the level set to parameter L3-17. This produces the shortest possible deceleration time while protecting the motor from stalling. The selected deceleration time is disregarded and the achievable deceleration time cannot be smaller than 1/10 of the set deceleration time.

This function uses the following parameters for adjusting the deceleration rate:

- DC bus voltage gain (L3-20)
- Deceleration rate calculations gain (L3-21)
- Inertia calculations for motor acceleration time (L3-24)
- Load inertia ratio (L3-25)

Note: The deceleration time is not constant. Do not use Intelligent Stall Prevention in applications where stopping accuracy is a concern. Use dynamic braking options instead.

Setting 3: Stall Prevention with dynamic braking option

Enables the Stall Prevention function while using a dynamic braking resistor.

Setting 4: Overexcitation Deceleration 1

Overexcitation Deceleration 1 (increasing the motor flux) is faster than deceleration with no Stall Prevention (L3-04 = 0). Setting 4 changes the selected decel time and functions to provide protection from an overvoltage trip.

Setting 5: Overexcitation Deceleration 2

Overexcitation Deceleration 2 slows down the motor while trying to maintain the DC bus voltage at the level set to parameter L3-17. This function shortens the achievable deceleration time more than by using Overexcitation Deceleration 1. Setting 5 will shorten/lengthen the decel time to maintain the L3-17 bus level.

■ L3-05: Stall Prevention Selection during Run

Determines how Stall Prevention works during Run. Stall Prevention during run prevents the motor from stalling by automatically reducing the speed when a transient overload occurs while the motor is running at constant speed.

No.	Name	Setting Range	Default
L3-05	Stall Prevention Selection During Run	0 to 2	1

Note: Stall Prevention during run is disabled when the output frequency is 6 Hz or lower regardless of the L3-05 and L3-06 settings.

Setting 0: Disabled

Drive runs at the set frequency reference. A heavy load may cause the motor to stall and trip the drive with an oC or oL fault.

Setting 1: Decelerate using C1-02

If the current exceeds the Stall Prevention level set in parameter L3-06, the drive will decelerate at decel time 1 (C1-02). When the current level drops below the value of L3-06 minus 2% for 100 ms, the drive accelerates back to the frequency reference at the active acceleration time.

Setting 2: Decelerate using C1-04

Same as setting 1 except the drive decelerates at decel time 2 (C1-04).

■ L3-06: Stall Prevention Level during Run

Sets the current level to trigger Stall Prevention during run. Depending on the setting of parameter L3-23, the level is automatically reduced in the constant power range (speed beyond base speed). A setting of 100% is equal to the drive rated current.

The Stall Prevention level can be adjusted using an analog input.

No.	Name	Setting Range	Default
L3-06	Stall Prevention Level During Run	30 to 150% </>	</>

<1> The upper limit and default for this setting is determined by L8-38.

4.7 Auto-Tuning

◆ Types of Auto-Tuning

The drive offers different types of Auto-Tuning for induction motors. Refer to the tables below to select the type of Auto-Tuning that best suits the application. [Refer to Start-Up Flowchart on page 82](#) for directions on executing Auto-Tuning.

■ Auto-Tuning for Induction Motors

This feature automatically sets the V/f pattern and motor parameters E1-□□ and E2-□□ for an induction motor.

Table 4.29 Types of Auto-Tuning for Induction Motors

Type	Setting	Application Conditions and Benefits
Stationary Auto-Tuning for Line-to-Line Resistance	T1-01 = 2	<ul style="list-style-type: none"> The drive is used in V/f Control and other Auto-Tuning selections are not possible. Perform when entering motor data manually while using motor cables longer than 50 m. Drive and motor capacities differ. Tunes the drive after the cable between the drive and motor has been replaced with a cable over 50 m long. Assumes Auto-Tuning has already been performed.
Rotational Auto-Tuning for V/f Control	T1-01 = 3	<ul style="list-style-type: none"> Recommended for applications using Speed Estimation Speed Search or using the Energy Saving function in V/f Control. Assumes motor can rotate while Auto-Tuning is executed. Increases accuracy for certain functions like torque compensation, slip compensation, Energy Saving, and Speed Search.

[Table 4.30](#) lists the data that must be entered for Auto-Tuning. Make sure this data is available before starting Auto-Tuning. The necessary information is usually listed on the motor nameplate or in the motor test report provided by the motor manufacturer. [Refer to Start-Up Flowchart on page 82](#) for details on the Auto-Tuning process.

Table 4.30 Auto-Tuning Input Data

Input Value	Input Parameter	Unit	Tuning Type (T1-01)	
			2 Line-to-Line Resistance	3 Rotational for V/f Control
Motor rated power	T1-02	kW	YES	YES
Motor rated voltage	T1-03	Vac	–	YES
Motor rated current	T1-04	A	YES	YES
Motor rated frequency	T1-05	Hz	–	YES
Number of motor poles	T1-06	-	–	YES
Motor rated Speed	T1-07	r/min	–	YES
Motor iron loss	T1-11	W	–	YES

◆ Auto-Tuning Interruption and Fault Codes

If tuning results are abnormal or the STOP key is pressed before completion, Auto-Tuning will be interrupted and a fault code will appear on the digital operator.

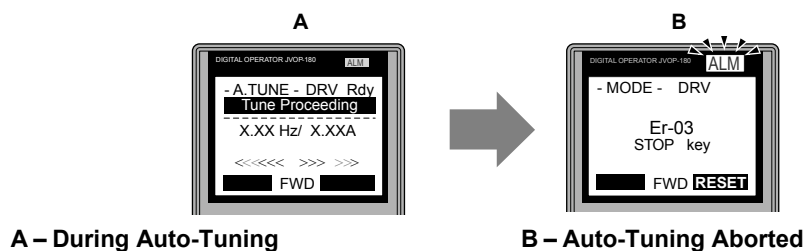

Figure 4.30 Auto-Tuning Aborted Display

◆ Auto-Tuning Operation Example

The following example demonstrates Stationary Auto-Tuning for Line-to-Line Resistance.

■ Selecting the Type of Auto-Tuning

Step		Display/Result
1.	Turn on the power to the drive. The initial display appears.	
2.	Press or until the Auto-Tuning display appears.	
3.	Press to begin setting parameters.	
4.	Press to display the value for T1-01.	
5.	Save the setting by pressing .	
6.	The display automatically returns to the display shown in Step 3.	

■ Enter Data from the Motor Nameplate

After selecting the type of Auto-Tuning, enter the data required from the motor nameplate.

Note: These instructions continue from Step 6 in “Selecting the Type of Auto-Tuning”.

Step		Display/Result
1.	Press to access the motor output power parameter T1-02.	
2.	Press to view the default setting.	
3.	Press , , , , and to enter the motor power nameplate data in kW.	
4.	Press to save the setting.	

4.7 Auto-Tuning

Step			Display/Result
5.	The display automatically returns to the display in Step 1.	→	<pre> -A.TUNE - PRG Rdy Mtr Rated Power ----- T1-02= 0.40kW (0.00 ~ 650.00) "0.75kW" [ESC] FWD [DATA] </pre>
6.	Repeat Steps 1 through 5 to set the following parameters: <ul style="list-style-type: none"> • T1-03, Motor Rated Voltage (Rotational Auto-Tuning for V/f Control only) • T1-04, Motor Rated Current • T1-05, Motor Base Frequency (Rotational Auto-Tuning for V/f Control only) • T1-06, Number of Motor Poles (Rotational Auto-Tuning for V/f Control only) • T1-07, Motor Base Frequency (Rotational Auto-Tuning for V/f Control only) 	→	<pre> -A.TUNE - PRG Rated Voltage ----- T1-03= 200.0VAC (0.0 ~ 255.0) "200.0VAC" [ESC] FWD [DATA] ⋮ ↓ -A.TUNE - PRG Rated Current ----- T1-04= X.XX A (0.35 ~ 7.00) "X.XX A" [ESC] FWD [DATA] </pre>

■ Starting Auto-Tuning



WARNING! Sudden Movement Hazard. The drive and motor may start unexpectedly during Auto-Tuning, which could result in death or serious injury. Ensure the area surrounding the drive motor and load are clear before proceeding with Auto-Tuning.

WARNING! Electrical Shock Hazard. High voltage will be supplied to the motor when Stationary Auto-Tuning is performed even with the motor stopped, which could result in death or serious injury. Do not touch the motor until Auto-Tuning has been completed.

NOTICE: Rotational Auto-Tuning will not function properly if a holding brake is engaged on the load. Failure to comply could result in improper operation of the drive. Ensure the motor can freely spin before beginning Auto-Tuning.

Enter the required information from the motor nameplate. Press  to proceed to the Auto-Tuning start display.

Note: These instructions continue from Step 6 in “Enter Data from the Motor Nameplate”.

Step			Display/Result
1.	After entering the data listed on the motor nameplate, press  to confirm.	→	<pre> -A.TUNE - DRV Rdy Auto-Tuning ----- 0.00 Hz/ 0.00A Tuning Ready ? Press RUN key [ESC] FWD [] </pre>
2.	Press  to activate Auto-Tuning. DRV flashes. The drive begins by injecting current into the motor for about 1 min, and then starts to rotate the motor. <p>Note: The first digit on the display indicates which motor is undergoing Auto-Tuning. The second digit indicates the type of Auto-Tuning being performed.</p>	→	<pre> -A.TUNE - DRV Rdy Tune Proceeding ----- X.XX Hz/ X.XXA <<<< >>>> [] FWD [] </pre>
3.	Auto-Tuning finishes in approximately one to two minutes.	→	<pre> - MODE - DRV ----- End Tune Successful [] FWD [RESET] </pre>

4.8 No-Load Operation Test Run

◆ No-Load Operation Test Run

This section explains how to operate the drive with the motor decoupled from the load during a test run.

■ Before Starting the Motor

Check the following items before operation:

- Ensure the area around the motor is safe.
- Ensure external emergency stop circuitry is working properly and other safety precautions have been taken.

■ During Operation

Check the following items during operation:

- The motor should rotate smoothly (i.e., no abnormal noise or oscillation).
- The motor should accelerate and decelerate smoothly.



■ No-Load Operation Instructions

The following example illustrates a test run procedure using the digital operator.

Note: Before starting the motor, set the frequency reference d1-01 to 6 Hz.

Step		Display/Result
1.	Turn on the power to the drive. The initial display appears.	
2.	Press to select LOCAL. The LO/RE light will turn on.	
3.	Press to give the drive a Run command. RUN will light and the motor will rotate at 6 Hz.	
4.	Ensure the motor is rotating in the correct direction and that no faults or alarms occur.	
5.	If there is no error in step 4, press to increase the frequency reference. Increase the frequency in increments of 10 Hz, verifying smooth operation at all speeds. For each frequency, check the drive output current using monitor U1-03. The current should be well below the motor rated current.	—

4.8 No-Load Operation Test Run

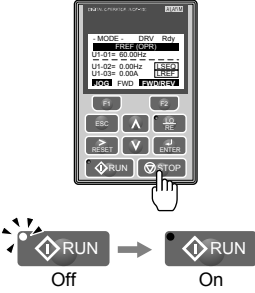
Step		Display/Result
<p>6. The drive should operate normally. Press  to stop the motor. RUN flashes until the motor comes to a complete stop.</p>		

4.9 Test Run with Load Connected

◆ Test Run with the Load Connected

After performing a no-load test run, connect the motor and proceed to run the motor and load together.

■ Precautions for Connected Machinery

WARNING! *Sudden Movement Hazard. Clear all personnel from the drive, motor, and machine area before applying power. System may start unexpectedly upon application of power, causing death or serious injury.*

WARNING! *Sudden Movement Hazard. Always check the operation of any fast stop circuits after they are wired. Fast stop circuits are required to provide safe and quick shutdown of the drive. Prepare to initiate an emergency stop during the test run. Operating a drive with untested emergency circuits could result in death or serious injury.*

- The motor should come to a complete stop without problems.
- Connect the load and machinery to the motor.
- Fasten all installation screws properly and check that the motor and connected machinery are held in place.

■ Checklist Before Operation

- The motor should rotate in the proper direction.
- The motor should accelerate and decelerate smoothly.

■ Operating the Motor under Loaded Conditions

Test run the application similarly to the no-load test procedure when connecting the machinery to the motor.

- Monitor U1-03 for overcurrent during operation.
- If the application permits running the load in the reverse direction, change the motor direction and the frequency reference while watching for abnormal motor oscillation or vibration.
- Correct any problems that occur with hunting, oscillation, and other control-related issues.

4.10 Test Run Checklist

Review the checklist before performing a test run. Check each item that applies.

<input checked="" type="checkbox"/>	No.	Checklist	Page
<input type="checkbox"/>	1	Thoroughly read the manual before performing a test run.	–
<input type="checkbox"/>	2	Turn the power on.	83
<input type="checkbox"/>	3	Set the voltage for the power supply to E1-01.	96

Check the items that correspond to the control mode being used.

WARNING! Sudden Movement Hazard. Ensure start/stop and safety circuits are wired properly and in the correct state before energizing the drive. Failure to comply could result in death or serious injury from moving equipment. When programmed for 3-Wire control, a momentary closure on terminal S1 may cause the drive to start.

<input checked="" type="checkbox"/>	No.	Checklist	Page
<input type="checkbox"/>	4	Select the best V/f pattern according to the application and motor characteristics.	–
<input type="checkbox"/>	5	Select Stationary Auto-Tuning for Line-to-Line Resistance or Rotational Auto-Tuning for V/f Control if using Energy Saving functions.	112
<input type="checkbox"/>	6	Decouple the motor for Rotational Auto-Tuning for V/f Control.	112
<input type="checkbox"/>	7	Enter the following data depending on Auto-Tuning method according to the information listed on the motor nameplate: <ul style="list-style-type: none"> • Motor rated power to T1-02 (kW) • Motor rated voltage to T1-03 (V) • Motor rated current to T1-04 (A) • Motor base frequency to T1-05 (Hz) • Number of motor poles to T1-06 • Motor base speed to T1-07 (r/min) 	–
<input type="checkbox"/>	8	The DRV should light after giving a Run command.	–
<input type="checkbox"/>	9	To give Run command and frequency reference from the digital operator, press “LO/RE” key to set to LOCAL.	80
<input type="checkbox"/>	10	If the motor rotates in the opposite direction during test run, switch two of U/T1, V/T2, W/T3, or change b1-14.	83
<input type="checkbox"/>	11	Set motor rated current (E2-01) and motor protection (L1-01) values for motor thermal protection.	–
<input type="checkbox"/>	12	Set the drive for REMOTE when control circuit terminals provide the Run command and frequency reference.	80
<input type="checkbox"/>	13	If the control circuit terminals should supply the frequency reference, select the correct voltage input signal level (0 to +10 V or -10 to +10 V) or the correct current input signal level (4 to 20 mA or 0 to 20 mA).	86
<input type="checkbox"/>	14	Set the proper signal level to terminals A1, A2, A3 (0 to 20 mA, 4 to 20 mA, 0 to +10 V or -10 to +10 V).	86
<input type="checkbox"/>	15	For A1, A2, and A3, when current input is used, switch the jumper on S1 from the V-side to I-side. Set the level for current signal used with parameter H3-01 for terminal A1, H3-09 for terminal A2, H3-05 for terminal A3, (set “2” for 4 to 20 mA, or “3” for 0 to 20 mA). V = Voltage, I = Current analog input signal.	86
<input type="checkbox"/>	16	If an analog input supplies the frequency reference, make sure it produces the desired frequency reference. Make the following adjustments if the drive does not operate as expected: Gain adjustment: Set the maximum voltage/current signal and adjust the analog input gain (H3-03 for A1, H3-11 for A2, H3-07 for A3) until the frequency reference value reaches the desired value. Bias adjustment: Set the minimum voltage/current signal and adjust the analog input bias (H3-04 for A1, H3-12 for A2, H3-08 for A3) until the frequency reference value reaches the desired minimum value.	–

4.11 Fan and Pump Application Presets

The following sections list the parameters affected by the different Application Presets.

◆ A1-03 = 8008: Pump

Table 4.31 Pump Application Parameters

Parameter	Name	Page
A1-06	Application Preset Selection (monitor only)	84
b1-01	Frequency Reference Selection	86
b1-02	Run Command Selection	87
b1-03	Stopping Method Selection	88
b1-04	Reverse Operation Selection	122
C1-01	Acceleration Time 1	93
C1-02	Deceleration Time 1	93
d1-01	Frequency Reference 1	94
E2-01	Motor Rated Current	100
L2-01	Momentary Power Loss Operation Selection	124
L5-01	Number of Auto Restart Attempts	125
L5-04	Fault Reset Interval Time	125
o1-06	User Monitor Selection Mode	126
o1-07	Second Line Monitor Selection	126
o1-08	Third Line Monitor Selection	126

◆ A1-03 = 8009: Pump w/ PI

Table 4.32 Pump w/ PI Application Parameters

Parameter	Name	Page
A1-06	Application Preset Selection (monitor only)	84
b1-02	Run Command Selection	87
b1-03	Stopping Method Selection	88
b1-04	Reverse Operation Selection	122
b5-19	PID Setpoint Value	122
b5-38	PID Setpoint User Display	123
b5-39	PID Setpoint Display Digits	123
b5-46	PID Unit Selection	123
b5-90	EZ Sleep Unit	123
b5-91	EZ Minimum Speed	123
b5-92	EZ Sleep Level	124
b5-94	EZ Wake-up Level	124
C1-01	Acceleration Time 1	93
C1-02	Deceleration Time 1	93
E2-01	Motor Rated Current	100
H3-09	Terminal A2 Signal Level Selection	106
L5-01	Number of Auto Restart Attempts	125
L5-04	Fault Reset Interval Time	125
o1-07	Second Line Monitor Selection	126
o1-08	Third Line Monitor Selection	126

4.11 Fan and Pump Application Presets

◆ A1-03 = 8010: Fan

Table 4.33 Fan Application Parameters

Parameter	Name	Page
A1-06	Application Preset Selection (monitor only)	84
b1-01	Frequency Reference Selection	86
b1-02	Run Command Selection	87
b1-03	Stopping Method Selection	88
b1-04	Reverse Operation Selection	122
C1-01	Acceleration Time 1	93
C1-02	Deceleration Time 1	93
d1-01	Frequency Reference 1	94
d2-01	Frequency Reference Upper Limit	124
d2-02	Frequency Reference Lower Limit	124
E2-01	Motor Rated Current	100
L5-01	Number of Auto Restart Attempts	125
L5-04	Fault Reset Interval Time	125
o1-06	User Monitor Selection Mode	126
o1-07	Second Line Monitor Selection	126
o1-08	Third Line Monitor Selection	126

◆ A1-03 = 8011: Fan w/ PI

Table 4.34 Fan Application Parameters

Parameter	Name	Page
A1-06	Application Preset Selection (monitor only)	84
b1-02	Run Command Selection	87
b1-03	Stopping Method Selection	88
b1-04	Reverse Operation Selection	122
b5-12	PI Feedback Loss Detection Selection	122
b5-19	PID Setpoint Value	122
b5-38	PID Setpoint User Display	123
b5-39	PID Setpoint Display Digits	123
b5-46	PID Unit Selection	123
b5-90	EZ Sleep Unit	123
b5-91	EZ Minimum Speed	123
b5-92	EZ Sleep Level	124
b5-94	EZ Wake-up Level	124
C1-01	Acceleration Time 1	93
C1-02	Deceleration Time 1	93
E2-01	Motor Rated Current	100
H3-09	Terminal A2 Signal Level Selection	106
L5-01	Number of Auto Restart Attempts	125
L5-04	Fault Reset Interval Time	125
o1-07	Second Line Monitor Selection	126
o1-08	Third Line Monitor Selection	126

◆ Default Values for Fan and Pump Applications

Table 4.35 Fan and Pump Application Defaults

Parameter	A1-03 Setting			
	8008	8009	8010	8011
A1-02	0: V/f Control	0: V/f Control	0: V/f Control	0: V/f Control
b1-04	–	–	1: Reverse Disabled	1: Reverse Disabled
b3-05	–	–	10.0 s	10.0 s
b5-01	–	1: PID Enabled	–	1: PID Enabled
b5-03	–	–	–	5.0 s
b5-08	–	–	–	2.00 s
b5-13	–	–	–	2%
b5-14	–	–	–	25.0 s
b5-18	–	1: Enabled (b5-19)	–	1: Enabled (b5-19)
b5-20	–	3: User Set	–	3: User Set
b5-46	–	–	–	1: PSI
b5-89	–	1: EZ Sleep/Wake Up	–	1: EZ Sleep/Wake Up
C1-01	–	–	90.0 s	60.0 s
C1-02	–	–	90.0 s	60.0 s
C2-01	–	–	5.00 s	5.00 s
C2-02	–	–	5.00 s	5.00 s
C2-03	–	–	5.00 s	5.00 s
C2-04	–	–	5.00 s	5.00 s
H3-10	–	B: PID Feedback	–	B: PID Feedback
L2-01	2: CPU Active	2: CPU Active	2: CPU Active	2: CPU Active
L3-02	–	–	110%	110%
L3-06	–	–	100%	100%
L4-05	–	–	0: Stop	–
L5-04	–	–	180.0 s	180.0 s
L5-05	1: L5-04 Interval	1: L5-04 Interval	1: L5-04 Interval	1: L5-04 Interval
o1-06	–	1: Selectable	–	1: Selectable
o1-07	–	102: Output Frequency	–	102: Output Frequency
o1-08	–	501: Feedback	–	501: Feedback

4.12 Fan and Pump Application Preset Details

■ b1-04: Reverse Operation Selection

Enables and disables Reverse operation. For some applications, reverse motor rotation is not appropriate and may cause problems (e.g., air handling units, pumps, etc.).

No.	Parameter Name	Setting Range	Default
b1-04	Reverse Operation Selection	0, 1	0

Setting 0: Reverse operation enabled

Possible to operate the motor in both forward and reverse directions.

Setting 1: Reverse operation disabled

Drive disregards a Reverse run command or a negative frequency reference.

■ b5-12: PID Feedback Loss Detection Selection

Enables or disables the feedback loss detection and sets the operation when a feedback loss is detected.

No.	Parameter Name	Setting Range	Default
b5-12	PID Feedback Loss Detection Selection	0 to 5	0

Setting 0: Digital Output Only

A digital output set for “PID feedback low” (H2-□□ = 3E) will be triggered if the PID feedback value is below the detection level set to b5-13 for the time set to b5-14 or longer. A digital output set for “PID feedback high” (H2-□□ = 3F) will be triggered if the PID feedback value is beyond the detection level set to b5-36 for longer than the time set to b5-37. Neither a fault nor an alarm is displayed on the digital operator and the drive will continue operation. The output resets when the feedback value leaves the loss detection range.

Setting 1: Feedback Loss Alarm

If the PID feedback value falls below the level set to b5-13 for longer than the time set to b5-14, a “FBL - Feedback Low” alarm will be displayed and a digital output set for “PID feedback low” (H2-□□ = 3E) will be triggered. If the PID feedback value exceeds the level set to b5-36 for longer than the time set to b5-37, a “FBH - Feedback High” alarm will be displayed and a digital output set for “PID feedback high” (H2-□□ = 3F) will be triggered. Both events trigger an alarm output (H1-□□ = 10). The drive will continue operation. The alarm and outputs reset when the feedback value leaves the loss detection range.

Setting 2: Feedback Loss Fault

If the PID feedback value falls below the level set to b5-13 for longer than the time set to b5-14, a “FbL - Feedback Low” fault will be displayed. If the PID feedback value exceeds the level set to b5-36 for longer than the time set to b5-37, a “FbH - Feedback High” fault will be displayed. Both events trigger a fault output (H1-□□ = E) and cause the drive to stop the motor.

Setting 3: Digital output only, even if PID is disabled by digital input

Same as b5-12 = 0. Detection remains active when PID is disabled by a digital input (H1-□□ = 19).

Setting 4: Feedback loss alarm, even if PID is disabled by digital input

Same as b5-12 = 1. Detection remains active when PID is disabled by a digital input (H1-□□ = 19).

Setting 5: Feedback loss fault, even if PID is disabled by digital input

Same as b5-12 = 2. Detection remains active when PID is disabled by a digital input (H1-□□ = 19).

■ b5-19: PID Setpoint Value

Used as the PID setpoint if parameter b5-18 = 1.

No.	Name	Setting Range	Default
b5-19	PID Setpoint Value	0.00 to 100.00%	0.00%

■ b5-38, b5-39: PID Setpoint User Display, PID Setpoint Display Digits

When parameter b5-20 is set to 3, parameters b5-38 and b5-39 set a user-defined display for the PID setpoint (b5-19) and PID feedback monitors (U5-01, U5-04).

Parameter b5-38 determines the display value when the maximum frequency is output and parameter b5-39 determines the number of digits. The setting value is equal to the number of decimal places.

No.	Name	Setting Range	Default
b5-38	PID Setpoint User Display	1 to 60000	Determined by b5-20
b5-39	PID Setpoint Display Digits	0 to 3	Determined by b5-20

■ b5-46: PI Setpoint Monitor Unit Selection

Sets the digital operator display units in U5-01 and U5-04 when b5-20 is set to 3.

No.	Name	Setting Range	Default
b5-46	PI Setpoint Monitor Unit Selection	0 to 15; 25	0

Setting 0: WC (Inch of Water)

Setting 1: PSI (Pounds per Square Inch)

Setting 2: GPM (Gallons per Minute)

Setting 3: F (Degrees Fahrenheit)

Setting 4: CFM (Cubic Feet per Minute)

Setting 5: CMH (Cubic Meters per Hour)

Setting 6: LPH (Liters per Hour)

Setting 7: LPS (Liters per Second)

Setting 8: Bar (Bar)

Setting 9: Pa (Pascal)

Setting 10: C (Degrees Celsius)

Setting 11: Mtr (Meters)

Setting 12: Ft (Feet)

Setting 13: LPN (Liters per Minute)

Setting 14: CMM (Cubic Meters per Minute)

Setting 15: "Hg (Inches of Mercury)

Setting 25: None

■ b5-90: EZ Sleep Unit

Sets the unit, range, and resolution of parameters b5-91 and b5-92.

No.	Name	Setting Range	Default
b5-90	EZ Sleep Unit	0, 1	0

Setting 0: Hz

Setting 1: RPM (number of motor poles must be entered)

■ b5-91: EZ Minimum Speed

Sets the PID minimum speed and integral lower limit.

The lower limit of the internal value is the higher of b5-34 and d2-02.

No.	Name	Setting Range	Default
b5-91	EZ Minimum Speed	0.0 to 400.0 Hz <F>	0.0

<F> Unit, range and resolution is determined by b5-90. Changing b5-90 will not automatically update the value of this parameter. Range is 0 to 24000 RPM when b5-90 is set to 1.

4.12 Fan and Pump Application Preset Details

■ b5-92: EZ Sleep Level

When the drive output frequency (or speed) is at or below this level for the time set in b5-93, the drive will go to sleep. The internal lower limit of this parameter is b5-91 (EZ Min Speed) + 1 Hz.

No.	Name	Setting Range	Default
b5-92	EZ Sleep Level	0.0 to 400.0 Hz <I>	0.0

<I> Unit, range and resolution is determined by b5-90. Changing b5-90 will not automatically update the value of this parameter. Range is 0 to 24000 RPM when b5-90 is set to 1.

■ b5-94: EZ Wake-up Level

If b5-95 is set to 0 (Absolute), the drive wakes-up when the PID Feedback (H3-□□ = 20) drops below this level for the time set in b5-96. For reverse-acting, the PID Feedback has to be above this level for the time set in b5-96.

If b5-95 is set to 1 (Setpoint Delta), the drive wakes-up when the PID Feedback (H3-□□ = 20) drops below the PID Setpoint minus this level (for normal acting PID) for the time set in b5-96. For reverse-acting, Wake-up level is PID Setpoint plus this level. The PID Feedback has to be above the wake-up level for the time set in b5-96.

No.	Name	Setting Range	Default
b5-94	EZ Wake-up Level	0.00 to 600.00% <I>	0.00

<I> Unit and resolution are determined by b5-20, b5-39, and b5-46. Internally limited to b5-38. Changing b5-20, b5-38 and b5-39 will not automatically update the value of this parameter.

■ d2-01: Frequency Reference Upper Limit

Sets the maximum frequency reference as a percentage of the maximum output frequency. This limit applies to all frequency references.

Even if the frequency reference is set to a higher value, the drive internal frequency reference will not exceed this value.

No.	Parameter Name	Setting Range	Default
d2-01	Frequency Reference Upper Limit	0.0 to 110.0%	100.0%

■ d2-02: Frequency Reference Lower Limit

Sets the minimum frequency reference as a percentage of the maximum output frequency. This limit applies to all frequency references.

If a lower reference than this value is entered, the drive will run at the limit set to d2-02. If the drive is started with a lower reference than d2-02, it will accelerate up to d2-02.

No.	Parameter Name	Setting Range	Default
d2-02	Frequency Reference Lower Limit	0.0 to 110.0%	0.0%

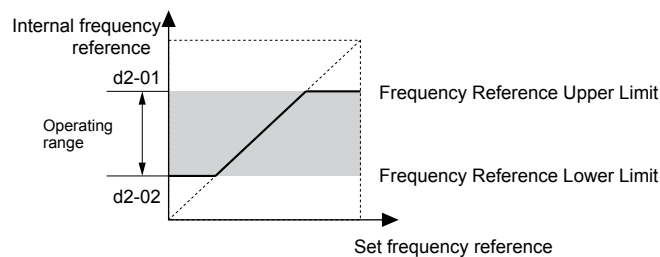

Figure 4.31 Frequency Reference: Upper and Lower Limits

■ L2-01: Momentary Power Loss Operation Selection

When a momentary power loss occurs (DC bus voltage falls below the level set in L2-05), the drive can automatically return to the operation it was performing prior to the power loss based on certain conditions.

No.	Name	Setting Range	Default
L2-01	Momentary Power Loss Operation Selection	0 to 5	2

Setting 0: Disabled (default)

If power is not restored within 15 ms, a Uv1 fault will result and the motor coasts to stop.

Setting 1: Recover within L2-02

When a momentary power loss occurs, the drive output will be shut off. If the power returns within the time set to parameter L2-02, the drive will perform Speed Search and attempt to resume operation. If power is not restored within this time (i.e., DC bus voltage level remains below Uv1 detection level L2-05), then a Uv1 fault is triggered and the drive will stop.

Setting 2: Recover as long as CPU has power

When a momentary power loss occurs, the drive output will be shut off. If the power returns and the drive control circuit has power, the drive will attempt to perform Speed Search and resume the operation. This will not trigger a Uv1 fault.

Setting 3: Kinetic Energy Backup (KEB) Ride-Thru operation within L2-02

The drive decelerates using regenerative energy from the motor until the time set in L2-02 has expired. It then tries to accelerate back to the frequency reference. If the power does not return within the time set to L2-02, it will trigger a Uv1 fault and the drive output will shut off. The type of KEB operation is determined by the L2-29 setting.

Setting 4: KEB Ride-Thru as long as CPU has power

The drive decelerates using regenerative energy from the motor until the power returns and then restarts. If the motor comes to a stop before the power returns, the drive loses control power and the drive output shuts off. A Uv1 fault is not triggered. The type of KEB operation is determined by the L2-29 setting.

Setting 5: Ramp to stop with KEB deceleration

The drive ramps to stop using the regenerative energy from the motor. Even if the power is restored, the drive will continue to decelerate until the motor comes to a complete stop. The type of KEB operation is determined by the L2-29 setting. If an input terminal set for KEB 1 (H1-□□ = 65, 66) is triggered while the drive is decelerating, it will accelerate back up to speed when the input is released.

Notes on Settings 1 through 5

- “Uv” will flash on the operator while the drive is attempting to recover from a momentary power loss. A fault signal is not output at this time.
- A Momentary Power Loss Unit is available to allow for a longer momentary power loss ride through time in models 2A0004 to 2A0056 and 4A0002 to 4A0031. This option makes it possible to continue running the drive after up to two seconds of power loss.
- When using a magnetic contactor between the motor and the drive, keep the magnetic contactor closed as long as the drive performs KEB operation or attempts to restart with Speed Search.
- Keep the Run command active during KEB operation or the drive cannot accelerate back to the frequency reference when the power returns.
- When L2-01 is set to 3, 4, or 5, KEB Ride-Thru will be executed as specified in L2-29.

■ L5-01: Number of Auto Restart Attempts

Sets the number of times that the drive may attempt to restart itself.

Parameter L5-05 determines the method of incrementing the restart counter. When the counter reaches the number set to L5-01, the operation stops and the fault must be manually cleared and reset.

The restart counter is incremented at each restart attempt, regardless of whether the attempt was successful. When the counter reaches the number set to L5-01, the operation stops and the fault must be manually cleared and reset.

The number of fault restarts is reset to zero when:

- The drive operates normally for 10 minutes following a fault restart.
- A fault is cleared manually after protective functions are triggered.
- The power supply is cycled.

No.	Name	Setting Range	Default
L5-01	Number of Auto Restart Attempts	0 to 10 Times	0 Times

■ L5-04: Fault Reset Interval Time

Determines the amount of time to wait between restart attempts when parameter L5-05 is set to 1.

No.	Name	Setting Range	Default
L5-04	Fault Reset Interval Time	0.5 to 600.0 s	10.0 s

4.12 Fan and Pump Application Preset Details

■ o1-06: User Monitor Selection Mode

Select between standard sequential monitors or selectable monitors to be displayed on the 2nd and 3rd lines of the digital operator display.

Use parameters o1-07 and o1-08 to select and fix the second and third monitors shown in the Home (Frequency Reference) and Monitor screen to ensure that those monitors are always visible when scrolling through the monitor list.

No.	Name	Setting Range	Default
o1-06	User Monitor Selection Mode	0, 1	0

Setting 0: 3 Mon Sequential (displays the next 2 sequential monitors)

Setting 1: 3 Mon Selectable (set by o1-07 and o1-08)

■ o1-07: Second Line User Monitor Selection

Selects the monitor that is shown in the second line. Effective only when o1-06 is set to 1.

Enter the last three digits of the monitor parameter number to be displayed: U□-□□. For example, set “403” to display monitor parameter U4-03.

No.	Name	Setting Range	Default
o1-07	Second Line User Monitor Selection	101 to 799	102

■ o1-08: Third Line User Monitor Selection

Selects the monitor that is shown in the third line. Effective only when o1-06 is set to 1.

Enter the last three digits of the monitor parameter number to be displayed: U□-□□. For example, set “403” to display monitor parameter U4-03.

No.	Name	Setting Range	Default
o1-07	Second Line User Monitor Selection	101 to 799	103

Troubleshooting

This chapter provides descriptions of the drive faults, alarms, errors, related displays, and guidance for troubleshooting. This chapter can also serve as a reference guide for tuning the drive during a trial run.

5.1	DRIVE ALARMS, FAULTS, AND ERRORS.....	128
5.2	FAULT DETECTION.....	129
5.3	ALARM DETECTION.....	139
5.4	OPERATOR PROGRAMMING ERRORS.....	142
5.5	AUTO-TUNING FAULT DETECTION.....	143
5.6	COPY FUNCTION RELATED DISPLAYS.....	146

5.1 Drive Alarms, Faults, and Errors

◆ Types of Alarms, Faults, and Errors

Check the digital operator for information about possible faults if the drive or motor fails to operate. *Refer to Using the Digital Operator on page 72.*

If problems occur that are not covered in this manual, contact the nearest Yaskawa representative with the following information:

- Drive model
- Software version
- Date of purchase
- Description of the problem

Table 5.1 contains descriptions of the various types of alarms, faults, and errors that may occur while operating the drive.

Table 5.1 Types of Alarms, Faults, and Errors

Type	Drive Response
Faults	<p>When the drive detects a fault:</p> <ul style="list-style-type: none"> • The digital operator displays text indicating the specific fault and the ALM indicator LED remains lit until the fault is reset. • The fault interrupts drive output and the motor coasts to a stop. • Some faults allow the user to select the stopping method when the fault occurs. • Fault output terminals MA-MC will close, and MB-MC will open. <p>The drive will remain inoperable until the fault is cleared. <i>Refer to Fault Reset Methods on page 146.</i></p>
Minor Faults and Alarms	<p>When the drive detects an alarm or a minor fault:</p> <ul style="list-style-type: none"> • The digital operator displays text indicating the specific alarm or minor fault, and the ALM indicator LED flashes. • The drive continues running the motor, although some alarms allow the user to select a stopping method when the alarm occurs. • A multi-function contact output set to be tripped by a minor fault (H2- □□ = 10) closes. If the output is set to be tripped by an alarm, the contact will not close. • The digital operator displays text indicating a specific alarm and the ALM indicator LED flashes. <p>Remove the cause of the problem to reset a minor fault or alarm.</p>
Operation Errors	<p>An operation error occurs when parameter settings conflict or do not match hardware settings (such as with an option card). When the drive detects an operation error:</p> <ul style="list-style-type: none"> • The digital operator displays text indicating the specific error. • Multi-function contact outputs do not operate. <p>The drive will not operate the motor until the error has been reset. Correct the settings that caused the operation error to clear the error.</p>
Tuning Errors	<p>Tuning errors occur while performing Auto-Tuning. When the drive detects a tuning error:</p> <ul style="list-style-type: none"> • The digital operator displays text indicating the specific error. • Multi-function contact outputs do not operate. • Motor coasts to stop. <p>Remove the cause of the error and repeat the Auto-Tuning process.</p>
Copy Function Errors	<p>Copy Function Errors occur when using the digital operator or the USB Copy Unit to copy, read, or verify parameter settings.</p> <ul style="list-style-type: none"> • The digital operator displays text indicating the specific error. • Multi-function contact outputs do not operate. <p>Pressing any key on the digital operator will clear the fault. Investigate the cause of the problem (such as model incompatibility) and try again.</p>

5.2 Fault Detection

◆ Fault Displays, Causes, and Possible Solutions

Faults are detected for drive protection, and cause the drive to stop while triggering the fault output terminal MA-MB-MC. Remove the cause of the fault and manually clear the fault before attempting to run the drive again.

Table 5.2 Detailed Fault Displays, Causes, and Possible Solutions

Digital Operator Display		Fault Name
bAT	bAT	Digital Operator Battery Voltage Low
Cause		Possible Solution
The digital operator battery is low		Replace the digital operator battery.
Digital Operator Display		Fault Name
boL	boL	Braking Transistor Overload Fault
		The braking transistor reached its overload level.
Digital Operator Display		Fault Name
bUS	bUS	Option Communication Error
		<ul style="list-style-type: none"> The connection was lost after establishing initial communication. Only detected when the run command frequency reference is assigned to an option card.
Cause		Possible Solution
No signal was received from the PLC		<ul style="list-style-type: none"> Check for faulty wiring. Correct the wiring. Check for disconnected cables and short circuits and repair as needed.
Faulty communications wiring or an existing short circuit		
Communication data error occurred due to noise		<ul style="list-style-type: none"> Check the various options available to minimize the effects of noise. Counteract noise in the control circuit, main circuit, and ground wiring. Ensure that other equipment such as switches or relays do not cause noise. Use surge absorbers if necessary. Use only recommended cables or other shielded line. Ground the shield on the controller side or the drive input power side. Separate all communication wiring from drive power lines. Install an EMC noise filter to the drive power supply input.
The option card is damaged		Replace the option card if there are no problems with the wiring and the error continues to occur.
The option card is not properly connected to the drive		<ul style="list-style-type: none"> The connector pins on the option card do not line up properly with the connector pins on the drive. Reinstall the option card.
Digital Operator Display		Fault Name
CE	CE	MEMOBUS/Modbus Communication Error
		Control data was not received for the CE detection time set to H5-09.
Cause		Possible Solution
Faulty communications wiring or an existing short circuit		<ul style="list-style-type: none"> Check for faulty wiring. Correct the wiring. Check for disconnected cables and short circuits and repair as needed.
Communication data error occurred due to noise		<ul style="list-style-type: none"> Check the various options available to minimize the effects of noise. Counteract noise in the control circuit, main circuit, and ground wiring. Use only recommended cables or other shielded line. Ground the shield on the controller side or the drive input power side. Ensure that other equipment such as switches or relays do not cause noise. Use surge suppressors if required. Separate all communication wiring from drive power lines. Install an EMC noise filter to the drive power supply input.
CPF00 or CPF01	CPF11 to CPF14 CPF16 to CPF19	Control Circuit Error
CPF02	CPF02	A/D Conversion Error
		An A/D conversion error or control circuit error occurred.

5.2 Fault Detection

<i>CPF03</i>	CPF03	Control Board Connection Error Connection error between the control board and the drive
<i>CPF06</i>	CPF06	EEPROM Memory Data Error Error in the data saved to EEPROM
Cause		Possible Solution
There is an error in EEPROM control circuit		<ul style="list-style-type: none"> Turn off the power and check the connection between the control board and the drive. If the problem continues, replace the control board or the entire drive. Contact Yaskawa or a Yaskawa representative for instructions on replacing the control board.
The power supply was switched off while parameters were being saved to the drive		Reinitialize the drive (A1-03 = 2220, 3330).
Digital Operator Display		Fault Name
<i>CPF07</i>	CPF07	Terminal Board Connection Error
<i>CPF08</i>	CPF08	
<i>CPF20</i> or <i>CPF21</i>	CPF20 or CPF21	Control Circuit Error
<i>CPF22</i>	CPF22	Hybrid IC Failure
<i>CPF23</i>	CPF23	Control Board Connection Error Connection error between the control board and the drive
<i>CPF24</i>	CPF24	Drive Unit Signal Fault The drive capacity cannot be detected correctly (drive capacity is checked when the drive is powered up).
<i>CPF25</i>	CPF25	Terminal Board Not Connected
<i>CPF26</i> to <i>CPF35</i> <i>CPF40</i> to <i>CPF43</i>	CPF26 to CPF35 CPF40 to CPF43	Control Circuit Error CPU error
Cause		Possible Solution
Hardware is damaged		If the problem continues, replace the control board or the entire drive. Contact Yaskawa or a Yaskawa representative for instructions on replacing the control board.
<i>E5</i>	E5	SI-T3 Watchdog Timer Error The watchdog timed out.
<i>EF0</i>	EF0	Option Card External Fault An external fault condition is present.
Cause		Possible Solution
An external fault was received from the PLC and F6-03 is set to a value other than 3.		<ul style="list-style-type: none"> Remove the cause of the external fault. Remove the external fault input from the PLC.
Problem with the PLC program		Check the PLC program and correct problems.
Digital Operator Display		Fault Name
<i>EF1</i>	EF1	External Fault (input terminal S1) External fault at multi-function input terminal S1.
<i>EF2</i>	EF2	External Fault (input terminal S2) External fault at multi-function input terminal S2.
<i>EF3</i>	EF3	External Fault (input terminal S3) External fault at multi-function input terminal S3.
<i>EF4</i>	EF4	External Fault (input terminal S4) External fault at multi-function input terminal S4.
<i>EF5</i>	EF5	External Fault (input terminal S5) External fault at multi-function input terminal S5.
<i>EF6</i>	EF6	External Fault (input terminal S6) External fault at multi-function input terminal S6.

<i>EF7</i>	EF7	External Fault (input terminal S7)
		External fault at multi-function input terminal S7.
<i>EF8</i>	EF8	External Fault (input terminal S8)
		External fault at multi-function input terminal S8.
Cause		Possible Solution
An external device tripped an alarm function		Remove the cause of the external fault and reset the fault.
Wiring is incorrect		<ul style="list-style-type: none"> Properly connect the signal lines to the terminals assigned for external fault detection (H1-□□ = 20 to 2B). Reconnect the signal line.
Multi-function contact input setting is incorrect		<ul style="list-style-type: none"> Check for unused terminals set for H1-□□ = 20 to 2B (External Fault). Change the terminal settings.

Digital Operator Display		Fault Name
<i>Err</i>	Err	EEPROM Write Error
		Data cannot be written to the EEPROM

<i>FAn</i>	FAn	Internal Fan Fault
		Fan or magnetic contactor failure

<i>FbH</i>	FbH	Excessive PID Feedback
		PID feedback input is greater than the level set to b5-36 for longer than the time set to b5-37. Set b5-12 to 2 or 5 to enable fault detection.

<i>FbL</i>	FbL	PID Feedback Loss
		PID feedback loss detection is programmed to trigger a fault (b5-12 = 2 or 5) and the PID feedback level is below the detection level set to b5-13 for longer than the time set to b5-14.

<i>GF</i>	GF	Ground Fault
		<ul style="list-style-type: none"> A current short to ground exceeded 50% of rated current on the output side of the drive. Setting L8-09 to 1 enables ground fault detection.

Cause		Possible Solution
Motor insulation is damaged		<ul style="list-style-type: none"> Check the insulation resistance of the motor. Replace the motor.
A damaged motor cable is creating a short circuit		<ul style="list-style-type: none"> Check the motor cable. Remove the short circuit and reapply power to the drive Check the resistance between the cable and the ground terminal ⊕. Replace the cable.
Excessive leakage current at the drive output		<ul style="list-style-type: none"> Reduce the carrier frequency. Reduce the amount of stray capacitance.
The drive started to run during a current offset fault or while coasting to a stop		<ul style="list-style-type: none"> Set b3-01 to 1 to enable Speed Search at Start. Perform Speed Search 1 or 2 (H1-□□ = 61 or 62) via one of the external terminals.
Hardware problem		If the problem continues, replace the control board or the entire drive. Contact Yaskawa or a Yaskawa representative for instructions on replacing the control board.

Digital Operator Display		Fault Name
<i>LF</i>	LF	Output Phase Loss
		<ul style="list-style-type: none"> Phase loss on the output side of the drive. Setting L8-07 to 1 or 2 enables Phase Loss Detection.

Cause		Possible Solution
The output cable is disconnected		<ul style="list-style-type: none"> Check for wiring errors and properly connect the output cable. Correct the wiring.
The motor winding is damaged		<ul style="list-style-type: none"> Check the resistance between motor lines. Replace the motor if the winding is damaged.
The output terminal is loose		<ul style="list-style-type: none"> Apply the tightening torque specified in this manual to fasten the terminals. <i>Refer to Wire Gauges and Tightening Torque on page 51</i> for details.

5.2 Fault Detection

The rated current of the motor being used is less than 5% of the drive rated current	Check the drive and motor capacities.
An output transistor is damaged	If the problem continues, replace the control board or the entire drive. Contact Yaskawa or a Yaskawa representative for instructions on replacing the control board.
A single-phase motor is being used	The drive cannot operate a single phase motor.

Digital Operator Display		Fault Name
n5E	nSE	Node Setup Error
Cause		Possible Solution
The node setup terminal closed during run.		Stop the drive when using the node setup function.
A Run command was issued while the node setup function was active.		

Digital Operator Display		Fault Name
oC	oC	Overcurrent
Cause		Possible Solution
The motor has been damaged due to overheating or the motor insulation is damaged		<ul style="list-style-type: none"> Check the insulation resistance. Replace the motor.
One of the motor cables has shorted out or there is a grounding problem		<ul style="list-style-type: none"> Check the motor cables. Remove the short circuit and reapply power to the drive. Check the resistance between the motor cables and the ground terminal ⊕. Replace damaged cables.
The load is too heavy		<ul style="list-style-type: none"> Measure the current flowing into the motor. Replace the drive with a larger capacity drive if the current value exceeds the rated current. Determine if there is sudden fluctuation in the current level. Reduce the load to avoid sudden changes in the current level or switch to a larger drive.
The acceleration or deceleration times are too short		Calculate the torque needed during acceleration relative to the load inertia and the specified acceleration time. If it is not possible to set the proper amount of torque, make the following changes: <ul style="list-style-type: none"> Increase the acceleration time (C1-01, C1-03). Increase the S-curve characteristics (C2-01 through C2-04). Increase the capacity of the drive.
The drive is attempting to operate a specialized motor or a motor larger than the maximum size allowed		<ul style="list-style-type: none"> Check the motor capacity. Ensure that the rated capacity of the drive is greater than or equal to the capacity rating found on the motor nameplate.
Magnetic contactor (MC) on the output side of the drive has turned on or off		Set up the operation sequence so the MC does not trip while the drive is outputting current.
V/f setting is not operating as expected		<ul style="list-style-type: none"> Check the ratios between the voltage and frequency. Set parameters E1-04 through E1-10 appropriately. Lower the voltage if it is too high relative to the frequency.
Excessive torque compensation		<ul style="list-style-type: none"> Check the amount of torque compensation. Reduce the torque compensation gain (C4-01) until there is no speed loss and less current.
Drive fails to operate properly due to noise interference		<ul style="list-style-type: none"> Review the possible solutions provided for handling noise interference. Review the section on handling noise interference and check the control circuit lines, main circuit lines, and ground wiring.
Overexcitation gain is set too high		<ul style="list-style-type: none"> Check if the fault occurs simultaneously with overexcitation function operation. Consider motor flux saturation and reduce the value of n3-13 (Overexcitation Deceleration Gain).
Run command was applied while motor was coasting		<ul style="list-style-type: none"> Set b3-01 to 1 to enable Speed Search at Start. Program the Speed Search command input through one of the multi-function contact input terminals (H1-□□ = 61 or 62).
The rated output current of the drive is too small		Use a larger drive.

Digital Operator Display		Fault Name
oFA00	oFA00	Option Card Connection Error at Option Port CN5-A
		Option compatibility error

<i>oFA01</i>	oFA01	Option Card Fault at Option Port CN5-A Option not properly connected
<i>oFA03 to oFA06</i> <i>oFA10, oFA11</i>	oFA03 to oFA06 oFA10, oFA11	Option Card Error Occurred at Option Port CN5-A
<i>oFA12 to oFA17</i>	oFA12 to oFA17	Option Card Connection Error (CN5-A)
<i>oFA30 to oFA43</i>	oFA30 to oFA43	Communication Option Card Connection Error (CN5-A)
<i>oFb00</i>	oFb00	Option Card Fault at Option Port CN5-B Option compatibility error
<i>oFb01</i>	oFb01	Option Card Fault at Option Port CN5-B Option not properly connected
<i>oFb02</i>	oFb02	Option Card Fault at Option Port CN5-B Same type of option card is currently connected
<i>oFb03 to oFb11</i> <i>oFb12 to oFb17</i>	oFb03 to oFb11 oFb12 to oFb17	Option card error occurred at Option Port CN5-B
<i>oFC00</i>	oFC00	Option Card Connection Error at Option Port CN5-C Option compatibility error
<i>oFC01</i>	oFC01	Option Card Fault at Option Port CN5-C Option not properly connected
<i>oFC02</i>	oFC02	Option Card Fault at Option Port CN5-C Same type of option card is currently connected
<i>oFC03 to oFC11</i> <i>oFC12 to oFC17</i>	oFC03 to oFC11 oFC12 to oFC17	Option Card Error Occurred at Option Port CN5-C
<i>oFC50 to oFC55</i>	oFC50 to oFC55	Option Card Error Occurred at Option Port CN5-C
<i>oH</i>	oH	Heatsink Overheat The heatsink temperature exceeded the overheat pre-alarm level set to L8-02. The default value for L8-02 is determined by drive capacity (o2-04).
Cause		Possible Solution
Surrounding temperature is too high		<ul style="list-style-type: none"> Check the temperature surrounding the drive. Verify temperature is within drive specifications. Improve the air circulation within the enclosure panel. Install a fan or air conditioner to cool the surrounding area. Remove anything near the drive that might be producing excessive heat.
Load is too heavy		<ul style="list-style-type: none"> Measure the output current. Decrease the load. Lower the carrier frequency (C6-02).
Internal cooling fan is stopped		<ul style="list-style-type: none"> Replace the cooling fan. After replacing the cooling fan, set parameter o4-03 to 0 to reset the cooling fan maintenance.
Digital Operator Display		Fault Name
<i>oH1</i>	oH1	Overheat 1 (Heatsink Overheat) The heatsink temperature exceeded the drive overheat level. Overheat level is determined by drive capacity (o2-04).
Cause		Possible Solution
Surrounding temperature is too high		<ul style="list-style-type: none"> Check the temperature surrounding the drive. Improve the air circulation within the enclosure panel. Install a fan or air conditioner to cool the surrounding area. Remove anything near the drive that might be producing excessive heat.

5.2 Fault Detection

Load is too heavy	<ul style="list-style-type: none"> • Measure the output current. • Lower the carrier frequency (C6-02). • Reduce the load.
-------------------	---

Digital Operator Display		Fault Name
oL1	oL1	Motor Overload
		The electronic motor overload protection tripped
Cause		Possible Solution
Load is too heavy		Reduce the load.
Cycle times are too short during acceleration and deceleration		Increase the acceleration and deceleration times (C1-01 through C1-04).
A general-purpose motor is driven below the rated speed with a high load		<ul style="list-style-type: none"> • Reduce the load. • Increase the speed. • If the motor is supposed to operate at low speeds, either increase the motor capacity or use a motor specifically designed to operate in the desired speed range.
The output voltage is too high		<ul style="list-style-type: none"> • Adjust the user-set V/f pattern (E1-04 through E1-10) by reducing E1-08 and E1-10. • Do not set E1-08 and E1-10 too low. This reduces load tolerance at low speeds.
The wrong motor rated current is set to E2-01		<ul style="list-style-type: none"> • Check the motor-rated current. • Enter the motor rated current to parameter E2-01 as indicated on the motor nameplate.
The base frequency is set incorrectly		<ul style="list-style-type: none"> • Check the rated frequency indicated on the motor nameplate. • Enter the rated frequency to E1-06 (Base Frequency).
The electrical thermal protection characteristics and motor overload characteristics do not match		<ul style="list-style-type: none"> • Check the motor characteristics. • Correct the type of motor protection that has been selected (L1-01). • Install an external thermal relay.
The electrical thermal relay is operating at the wrong level		<ul style="list-style-type: none"> • Check the current rating listed on the motor nameplate. • Check the value set for the motor rated current (E2-01).
Motor overheated by overexcitation operation		<ul style="list-style-type: none"> • Overexcitation increases the motor loss and the motor temperature. Excessive duration of overexcitation may cause motor damage. Prevent excessive overexcitation operation or apply proper cooling to the motor. • Reduce the excitation deceleration gain (n3-13). • Set L3-04 (Stall Prevention during Deceleration) to a value other than 4.
Parameters related to Speed Search are set incorrectly		<ul style="list-style-type: none"> • Check values set to Speed Search related parameters. • Adjust the Speed Search current and Speed Search deceleration times (b3-02 and b3-03 respectively). • After Auto-Tuning, set b3-24 to 1 to enable Speed Estimation Speed Search.
Output current fluctuation due to power supply loss		Check the power supply for phase loss.

Digital Operator Display		Fault Name
oL2	oL2	Drive Overload
		The thermal sensor of the drive triggered overload protection.
Cause		Possible Solution
Load is too heavy		Reduce the load.
Acceleration or deceleration time is too short		Increase the settings for the acceleration and deceleration times (C1-01 through C1-04).
The output voltage is too high		<ul style="list-style-type: none"> • Adjust the preset V/f pattern (E1-04 through E1-10) by reducing E1-08 and E1-10. • Do not lower E1-08 and E1-10 excessively. This reduces load tolerance at low speeds.
Drive capacity is too small		Replace the drive with a larger model.
Overload occurred when operating at low speeds		<ul style="list-style-type: none"> • Reduce the load when operating at low speeds. • Replace the drive with a model that is one frame size larger. • Lower the carrier frequency (C6-02).
Excessive torque compensation		Reduce the torque compensation gain in parameter C4-01 until there is no speed loss but less current.
Parameters related to Speed Search are set incorrectly		<ul style="list-style-type: none"> • Check the settings for all Speed Search related parameters. • Adjust the current used during Speed Search (b3-03) and the Speed Search deceleration time (b3-02). • After Auto-Tuning, set b3-24 to 1 to enable Speed Estimation Speed Search.
Output current fluctuation due to input phase loss		Check the power supply for phase loss.

Digital Operator Display		Fault Name
oL3	oL3	Overtorque Detection 1
		The current has exceeded the value set for torque detection (L6-02) for longer than the allowable time (L6-03).
oL4	oL4	Overtorque Detection 2
		The current has exceeded the value set for Overtorque Detection 2 (L6-05) for longer than the allowable time (L6-06).
oL7	oL7	High Slip Braking oL
		The output frequency stayed constant for longer than the time set to n3-04 during High Slip Braking.
oPr	oPr	External Digital Operator Connection Fault
		The external operator has been disconnected from the drive. Note: An oPr fault will occur when all of the following conditions are true: • Output is interrupted when the operator is disconnected (o2-06 = 1). • The Run command is assigned to the operator (b1-02 = 0 and LOCAL has been selected).
ov	ov	Overvoltage
		Voltage in the DC bus has exceeded the overvoltage detection level. • For 200 V class drives: approximately 410 V • For 400 V class drives: approximately 820 V (740 V when E1-01 is less than 400) • For 600 V class drives: approximately 1040 V
Cause		Possible Solution
Deceleration time is too short and regenerative energy is flowing from the motor into the drive		<ul style="list-style-type: none"> • Increase the deceleration time (C1-02 and C1-04). • Install a dynamic braking resistor or a dynamic braking resistor unit. • Set L3-04 to 1 to enable stall prevention during deceleration. Stall Prevention is enabled as the default setting.
Fast acceleration time causes the motor to overshoot the speed reference		<ul style="list-style-type: none"> • Check if sudden drive acceleration triggers an overvoltage alarm. • Increase the acceleration time. • Use longer S-curve acceleration and deceleration times. • Enable the Overvoltage Suppression function (L3-11 = 1). • Lengthen the S-curve at acceleration end.
Excessive braking load		The braking torque was too high, causing regenerative energy to charge the DC bus. Reduce the braking torque, use a dynamic braking option, or lengthen decel time.
Surge voltage entering from the drive input power		Install a DC link choke. Note: Voltage surge can result from a thyristor convertor and phase advancing capacitor using the same input power supply.
Ground fault in the output circuit causes the DC bus capacitor to overcharge		<ul style="list-style-type: none"> • Check the motor wiring for ground faults. • Correct grounding shorts and reapply power.
Improper parameters related to Speed Search (including Speed Search after a momentary power loss and after a fault restart)		<ul style="list-style-type: none"> • Check the settings for Speed Search-related parameters. • Enable Speed Search restart function (b3-19 greater than or equal to 1 to 10). • Adjust the current level during Speed Search and the deceleration time (b3-02 and b3-03 respectively). • Perform Stationary Auto-Tuning for line-to-line resistance and then set b3-14 to 1 to enable Speed Estimation Speed Search.
Drive input power voltage is too high		<ul style="list-style-type: none"> • Check the voltage. • Lower drive input power voltage within the limits listed in the specifications.
The braking transistor or braking resistor are wired incorrectly		<ul style="list-style-type: none"> • Check braking transistor and braking resistor wiring for errors. • Properly rewire the braking resistor device.
Drive fails to operate properly due to noise interference		<ul style="list-style-type: none"> • Review the list of possible solutions provided for controlling noise. • Review the section on handling noise interference and check the control circuit lines, main circuit lines, and ground wiring.
Load inertia is set incorrectly		<ul style="list-style-type: none"> • Check the load inertia settings when using KEB, overvoltage suppression, or Stall Prevention during deceleration. • Adjust the load inertia ratio in L3-25 to better match the load.
Motor hunting occurs		<ul style="list-style-type: none"> • Adjust the parameters that control hunting. • Set the gain for Hunting Prevention (n1-02). • Adjust the AFR time constant (n2-02 and n2-03).

5.2 Fault Detection

Digital Operator Display		Fault Name
PF	PF	Input Phase Loss Drive input power has an open phase or has a large imbalance of voltage between phases. Detected when L8-05 is set 1 (enabled).
Cause		Possible Solution
There is phase loss in the drive input power		<ul style="list-style-type: none"> Check for wiring errors in the main circuit drive input power. Correct the wiring.
There is loose wiring in the drive input power terminals		<ul style="list-style-type: none"> Ensure the terminals are tightened properly. Apply the tightening torque as specified in this manual. <i>Refer to Wire Gauges and Tightening Torque on page 51</i> for details.
There is excessive fluctuation in the drive input power voltage		<ul style="list-style-type: none"> Check the voltage from the drive input power. Review the possible solutions for stabilizing the drive input power.
There is poor balance between voltage phases		Stabilize drive input power or disable phase loss detection.
The main circuit capacitors are worn		<ul style="list-style-type: none"> Check the maintenance time for the capacitors (U4-05). Replace the capacitor if U4-05 is greater than 90%. For instructions on replacing the capacitor, contact Yaskawa or a Yaskawa representative.
		Check for problems with the drive input power. If drive input power appears normal but the alarm continues to occur, replace either the control board or the entire drive. For instructions on replacing the control board, contact Yaskawa or a Yaskawa representative.
rF	rF	Braking Resistor Fault The resistance of the braking resistor is too low.
rH	rH	Braking Resistor Overheat Braking resistor protection was triggered. Fault detection is enabled when L8-01 = 1 (disabled as a default).
Cause		Possible Solution
Deceleration time is too short and excessive regenerative energy is flowing back into the drive		<ul style="list-style-type: none"> Check the load, deceleration time, and speed. Reduce the load inertia. Increase the deceleration times (C1-01 to C1-04). Replace the dynamic braking option with a larger device that can handle the power that is discharged.
The duty cycle is too high		Check the duty cycle. Maximum of 3% duty cycle is available when L8-01 = 1.
Excessive braking inertia		Recalculate braking load and braking power. Reduce the braking load by adjusting braking resistor settings.
The braking operation duty cycle is too high		Check the braking operation duty cycle. Braking resistor protection for ERF-type braking resistors (L8-01 = 1) allows a braking duty cycle of maximum 3%.
The proper braking resistor has not been installed		<ul style="list-style-type: none"> Check the specifications and conditions for the braking resistor device. Select the optimal braking resistor.
<p>Note: The magnitude of the braking load trips the braking resistor overheat alarm, NOT the surface temperature. Using the braking resistor more frequently than its rating permits will trip the alarm even when the braking resistor surface is not very hot.</p>		
Digital Operator Display		Fault Name
rr	rr	Dynamic Braking Transistor The built-in dynamic braking transistor failed.
Cause		Possible Solution
The braking transistor is damaged		<ul style="list-style-type: none"> Cycle power to the drive and check for reoccurrence of the fault.
The control circuit is damaged		<ul style="list-style-type: none"> Replace either the control board or the entire drive. For instructions on replacing the control board, contact Yaskawa or a Yaskawa representative.
Digital Operator Display		Fault Name
SC	SC	IGBT Short Circuit or Ground Fault
Digital Operator Display		Fault Name
SEr	SEr	Too Many Speed Search Restarts The number of Speed Search restarts exceeded the value set to b3-19.
Digital Operator Display		Fault Name
TdE	TdE	Time Data Error
Cause		Possible Solution

An error has occurred in the Real-Clock Time function of the digital operator		Replace the digital operator. For instructions on replacing the digital operator, contact Yaskawa or your nearest sales representative.
TIE	TIE	Time Interval Error
Cause		Possible Solution
An error has occurred in the Real-Clock Time function of the digital operator		Replace the digital operator. For instructions on replacing the digital operator, contact Yaskawa or your nearest sales representative.
TIM	TIM	Time Not Set
Cause		Possible Solution
The Real-Time Clock for the digital operator is not set in parameter o4-17		Set o4-17 to 1 to set the time for the digital operator. The drive will display the "TIM" alarm (Time Not Set) when the Real time Clock is not set. Additionally, at power up, if the "TIM" condition is present, the drive will automatically switch to the time setting screen (o4-17 = 1) for 30 seconds to prompt the user to set the Real-Time Clock.
<ul style="list-style-type: none"> The drive is a new drive, first power-up condition o4-17 was set to 2, Reset, by the user, manually clearing the Real-Time Clock data. 		
The user did not set the Real Time Clock when prompted following power-up.		Cycle power to the drive and set the Real Time Clock within 30 seconds of power-up, or set the clock manually via parameter o4-17.
The digital operator battery is low or the battery has been replaced		Replace the digital operator battery and set the Real-Time Clock.
An error has occurred in the Real-Time Clock function of the digital operator		Replace the digital operator. For instructions on replacing the digital operator, contact Yaskawa or your nearest sales representative.
UL3	UL3	Undertorque Detection 1
		The current has fallen below the minimum value set for torque detection (L6-02) for longer than the allowable time (L6-03).
Cause		Possible Solution
Parameter settings are not appropriate for the load		Check the settings of parameters L6-02 and L6-03.
There is a fault on the machine side		Check the load for any problems.
Digital Operator Display		Fault Name
UL4	UL4	Undertorque Detection 2
		The current has fallen below the minimum value set for torque detection (L6-05) for longer than the allowable time (L6-06).
Cause		Possible Solution
The output current has fallen below the motor underload curve defined in L6-14 for longer than the time set to L6-03		Adjust the value set to L6-14 so that output current remains above the motor underload curve during normal operation.
Uv1	Uv1	DC Bus Undervoltage
		One of the following conditions occurred while the drive was running:
		<ul style="list-style-type: none"> Voltage in the DC bus fell below the undervoltage detection level (L2-05). For 200 V class drives: approximately 190 V For 400 V class drives: approximately 380 V (350 V when E1-01 is less than 400) For 600 V class drives: approximately 475 V
		The fault is output only if L2-01 is set to 0 or 1 and the DC bus voltage has fallen below the level set to L2-05 for longer than the time set to L2-02.
Cause		Possible Solution
Input power phase loss		<ul style="list-style-type: none"> The main circuit drive input power is wired incorrectly. Correct the wiring.
One of the drive input power wiring terminals is loose		<ul style="list-style-type: none"> Ensure there are no loose terminals. Apply the tightening torque specified in this manual to fasten the terminals. <i>Refer to Wire Gauges and Tightening Torque on page 51</i> for details.

5.2 Fault Detection

There is a problem with the voltage from the drive input power	<ul style="list-style-type: none"> • Check the voltage. • Correct the voltage to be within the range listed in drive input power specifications. • If there is no problem with the power supply to the main circuit, check for problems with the main circuit magnetic contactor.
The power has been interrupted	Correct the drive input power.
The main circuit capacitors are worn	<ul style="list-style-type: none"> • Check the maintenance time for the capacitors (U4-05). • Replace either the control board or the entire drive if U4-05 exceeds 90%. For instructions on replacing the control board, contact Yaskawa or a Yaskawa representative.
The relay or contactor on the soft-charge bypass circuit is damaged	<ul style="list-style-type: none"> • Cycle power to the drive and see if the fault reoccurs. • If the problem continues, replace either the control board or the entire drive. For instructions on replacing the control board, contact Yaskawa or a Yaskawa representative. • Check monitor U4-06 for the performance life of the soft-charge bypass. • Replace either the control board or the entire drive if U4-06 exceeds 90%. For instructions on replacing the control board, contact Yaskawa or a Yaskawa representative.

Digital Operator Display		Fault Name
$Uv2$	Uv2	Control Power Supply Voltage Fault
		Voltage is too low for the control drive input power.
Cause		Possible Solution
In drive models 2A0004 to 2A0056 or 4A0002 to 4A0031, L2-02 was changed from its default value without installing a Momentary Power Loss Ride-Thru unit		Correct the setting to L2-02 or install an optional Momentary Power Loss Ride-Thru unit.
Control power supply wiring is damaged		<ul style="list-style-type: none"> • Cycle power to the drive. Check if the fault reoccurs. • If the problem continues, replace the control board, the entire drive, or the control power supply. For instructions on replacing the control board, contact Yaskawa or a Yaskawa representative.
Internal circuitry is damaged		<ul style="list-style-type: none"> • Cycle power to the drive. Check if the fault reoccurs. • If the problem continues, replace either the control board or the entire drive. For instructions on replacing the control board, contact Yaskawa or a Yaskawa representative.

Digital Operator Display		Fault Name
$Uv3$	Uv3	Undervoltage 3 (Soft-Charge Bypass Circuit Fault)
		The soft-charge bypass circuit failed.
voF	voF	Output Voltage Detection Fault
		Problem detected with the voltage on the output side of the drive.
$vToL$	vToL	VT Overload
Cause		Possible Solution
The output current of the drive has been elevated for a set length of time.		The application may not be suited for the drive <ul style="list-style-type: none"> • The application may not be suited for the drive • The drive is undersized for the load

5.3 Alarm Detection

◆ Alarm Codes, Causes, and Possible Solutions

Alarms are drive protection functions that do not necessarily cause the drive to stop. After removing the cause of an alarm, the drive will return to the same status it was before the alarm occurred.

When an alarm has been triggered, the ALM light on the digital operator display blinks and the alarm code display flashes. If a multi-function output is set for an alarm (H2-□□ = 10), that output terminal will be triggered.

Note: If a multi-function output is set to close when an alarm occurs (H2-□□ = 10), it will also close when maintenance periods are reached, triggering alarms LT-1 through LT-4 (triggered only if H2-□□ = 2F).

Table 5.3 Alarm Codes, Causes, and Possible Solutions

Digital Operator Display		Minor Fault Name
<i>AEr</i>	AEr	Communication Option Station Number Setting Error (CC-Link, CANopen, MECHATROLINK-II)
		Option card node address is outside of the acceptable setting range.
<i>bb</i>	bb	Baseblock
		Drive output interrupted as indicated by an external baseblock signal.
<i>boL</i>	boL	Braking Transistor Overload Fault
		The braking transistor in the drive has been overloaded.
<i>bUS</i>	bUS	Option Communication Error
		• The connection was lost after initial communication was established.
		• Assign a Run command frequency reference to the option.
<i>CALL</i>	CALL	Serial Communication Transmission Error
		Communication has not yet been established.
<i>CE</i>	CE	MEMOBUS/Modbus Communication Error
		Control data was not received correctly for two seconds.
<i>CrST</i>	CrST	Cannot Reset
<i>dnE</i>	dnE	Drive Disabled
<i>EF</i>	EF	Forward/Reverse Run Command Input Error
		Both forward run and reverse run closed simultaneously for longer than 0.5 s.
<i>EF0</i>	EF0	Option Card External Fault
		An external fault condition is present.
<i>EF1</i>	EF1	External Fault (Input Terminal S1)
		External fault at multi-function input terminal S1.
<i>EF2</i>	EF2	External fault (input terminal S2)
		External fault at multi-function input terminal S2.
<i>EF3</i>	EF3	External fault (input terminal S3)
		External fault at multi-function input terminal S3.
<i>EF4</i>	EF4	External fault (input terminal S4)
		External fault at multi-function input terminal S4.
<i>EF5</i>	EF5	External fault (input terminal S5)
		External fault at multi-function input terminal S5.
<i>EF6</i>	EF6	External fault (input terminal S6)
		External fault at multi-function input terminal S6.
<i>EF7</i>	EF7	External fault (input terminal S7)
		External fault at multi-function input terminal S7.

5.3 Alarm Detection

<i>EF8</i>	EF8	External fault (input terminal S8)
		External fault at multi-function input terminal S8.
EoF	EoF	Emergency Override Forward Run
Cause		Possible Solution
The multi-function digital input for EmergOverrideFWD (H1-□□ = AF) has been closed.		Open H1-□□ = AF if the emergency condition is no longer present
Eor	Eor	Emergency Override Reverse Run
Cause		Possible Solution
The multi-function digital input for EmergOverrideREV (H1-□□ = B0) has been closed.		Open H1-□□ = B0 if the emergency condition is no longer present
<i>FbH</i>	FbH	Excessive PID Feedback
		The PID feedback input is higher than the level set to b5-36 for longer than the time set to b5-37, and b5-12 is set to 1 or 4.
<i>FbL</i>	FbL	PID Feedback Loss
		The PID feedback input is lower than the level set to b5-13 for longer than the time set to b5-14.
<i>HCA</i>	HCA	Current Alarm
		Drive current exceeded overcurrent warning level (150% of the rated current).
<i>LT-1</i>	LT-1	Cooling Fan Maintenance Time
		The cooling fan has reached its expected maintenance period and may need to be replaced. Note: An alarm output (H2-□□ = 10) will only be triggered if both (H2-□□ = 2F and H2-□□ = 10) are set.
<i>LT-2</i>	LT-2	Capacitor Maintenance Time
		The main circuit and control circuit capacitors are nearing the end of their expected performance life. Note: An alarm output (H2-□□ = 10) will only be triggered if H2-□□ = 2F.
<i>LT-3</i>	LT-3	Soft Charge Bypass Relay Maintenance Time
		The DC bus soft charge relay is nearing the end of its expected performance life. Note: An alarm output (H2-□□ = 10) will only be triggered if H2-□□ = 2F.
<i>LT-4</i>	LT-4	IGBT Maintenance Time (50%)
		IGBTs have reached 50% of their expected performance life. Note: An alarm output (H2-□□ = 10) will only be triggered if H2-□□ = 2F.
<i>oH</i>	oH	Heatsink Overheat
		The temperature of the heatsink exceeded the overheat pre-alarm level set to L8-02 (90-100 °C). Default value for L8-02 is determined by drive capacity (o2-04).
<i>oH2</i>	oH2	Drive Overheat Warning
		“Drive Overheat Warning” was input to a multi-function input terminal, S1 through S8 (H1-□□ = B).
<i>oH3</i>	oH3	Motor Overheat
		The motor overheat signal entered to a multi-function analog input terminal exceeded the alarm level (H3-02, H3-06 or H3-10 = E).
<i>oH4</i>	oH4	Motor Overheat Fault (PTC Input)
		<ul style="list-style-type: none"> The motor overheat signal to analog input terminal A1, A2, or A3 exceeded the fault detection level. Detection requires setting multi-function analog inputs H3-02, H3-10, or H3-06 to E.
Cause		Possible Solution

Motor has overheated		<ul style="list-style-type: none"> • Check the size of the load, the accel/decel times, and the cycle times. • Decrease the load. • Increase the acceleration and deceleration times (C1-01 through C1-04).
		<ul style="list-style-type: none"> • Adjust the preset V/f pattern (E1-04 through E1-10) by reducing E1-08 and E1-10. • Do not set E1-08 and E1-10 too low. This reduces load tolerance at low speeds.
		<ul style="list-style-type: none"> • Check the motor rated current. • Enter the motor rated current to parameter E2-01 as indicated on the motor nameplate. • Ensure the motor cooling system is operating normally. • Repair or replace the motor cooling system.
<i>ov</i>	ov	<p>DC Bus Overvoltage</p> <p>The DC bus voltage exceeded the trip point.</p> <ul style="list-style-type: none"> • For 200 V class drives: approximately 410 V • For 400 V class drives: approximately 820 V (740 V when E1-01 is less than 400) • For 600 V class drives: approximately 1040 V
<i>PASS</i>	PASS	MEMOBUS/Modbus Comm. Test Mode Complete
<i>rUn</i>	rUn	<p>Motor Switch during Run</p> <p>A command to switch motors was entered during run.</p>
<i>SE</i>	SE	<p>MEMOBUS/Modbus Communication Test Mode Error</p> <p>Note: This alarm will not trigger a multi-function output terminal that is set for alarm output (H2-□□ = 10).</p>
<i>TrPC</i>	TrPC	<p>IGBT Maintenance Time (90%)</p> <p>IGBTs have reached 90% of their expected performance life.</p>
<i>Uv</i>	Uv	<p>Undervoltage</p> <p>One of the following conditions was true when the drive was stopped and a Run command was entered:</p> <ul style="list-style-type: none"> • DC bus voltage dropped below the level specified in L2-05. • Contactor to suppress inrush current in the drive was opened. • Low voltage in the control drive input power. This alarm outputs only if L2-01 is not 0 and DC bus voltage is under L2-05.
<i>WrUn</i>	WrUn	Waiting for Run
Cause		Possible Solutions
The Run command has been applied and the b1-11 timer is active.		Adjust b1-11 to the desired delay time. The drive will start normally after the b1-11 timer expires.

5.4 Operator Programming Errors

◆ Operator Programming Error Codes, Causes, and Possible Solutions

An Operator Programming Error (oPE) occurs when a contradictory parameter is set or an individual parameter is set to an inappropriate value.

The drive will not operate until the parameter or parameters causing the problem are set correctly. An oPE, however, does not trigger an alarm or fault output. If an oPE occurs, investigate the cause and refer to [Table 5.4](#) for the appropriate action. When an oPE appears on the operator display, press the ENTER button to view U1-18 and see which parameter is causing the oPE.

Table 5.4 oPE Codes, Causes, and Possible Solutions

Digital Operator Display		Error Name
oPE01	oPE01	Drive Capacity Setting Fault
		Drive capacity and the value set to o2-04 do not match.
oPE02	oPE02	Parameter Range Setting Error
		Use U1-18 to find parameters set outside the range.
oPE03	oPE03	Multi-Function Input Selection Error
		A contradictory setting is assigned to multi-function contact inputs H1-01 to H1-08.
oPE04	oPE04	Initialization Required, Term <-> Ctrl Chg
oPE05	oPE05	Run Command/Frequency Reference Source Selection Error
oPE07	oPE07	Multi-Function Analog Input Selection Error
		A contradictory setting is assigned to multi-function analog inputs H3-02, H3-10, or H3-06 and PID functions conflict.
oPE09	oPE09	PID Control Selection Fault
		PID control function selection is incorrect. Requires that PID control is enabled (b5-01 = 1 to 4).
oPE10	oPE10	V/f Data Setting Error
		One of the following setting errors has occurred: E1-09 ≤ E1-07 < E1-06 ≤ E1-11 ≤ E1-04
oPE11	oPE11	Carrier Frequency Setting Error
		Correct the setting for the carrier frequency.
oPE28	oPE28	Sequence Timer Error
		One or more of the sequence timers is not set in the correct order.

5.5 Auto-Tuning Fault Detection

When the Auto-Tuning faults shown below are detected, the fault is displayed on the operator and the motor coasts to a stop. Auto-Tuning faults do not trigger a multi-function terminal set for fault or alarm output.

An End□ error indicates that although Auto-Tuning has successfully completed, there is some discrepancy in the calculations. If an End□ error occurs, check for the cause of the error using the table in this section, and perform Auto-Tuning again or manually set the motor parameters after fixing the problem. Start the application if no problem can be diagnosed despite the existence of the End□ error.

◆ Auto-Tuning Codes, Causes, and Possible Solutions

Table 5.5 Auto-Tuning Codes, Causes, and Possible Solutions

Digital Operator Display		Error Name
<i>End1</i>	End1	Excessive V/f Setting (detected only during Rotational Auto-Tuning and displayed after Auto-Tuning is complete)
Cause		Possible Solutions
The torque reference exceeded 20% during Auto-Tuning.		<ul style="list-style-type: none"> • Prior to Auto-Tuning, verify the information on the motor nameplate. • Enter proper values from motor nameplate to parameters T1-02 and T1-04 and repeat Auto-Tuning.
The results from Auto-Tuning the no-load current exceeded 80%.		<ul style="list-style-type: none"> • If possible, disconnect the motor from the load and perform Auto-Tuning. If the load cannot be uncoupled, use the current Auto-Tuning results.
Digital Operator Display		Error Name
<i>End2</i>	End2	Motor Iron-Core Saturation Coefficient (detected only during Rotational Auto-Tuning and displayed after Auto-Tuning is complete)
Cause		Possible Solutions
Motor data entered during Auto-Tuning was incorrect.		<ul style="list-style-type: none"> • Make sure the data entered to the T1 parameters match the information written on the motor nameplate. • Restart Auto-Tuning and enter the correct information.
Results from Auto-Tuning are outside the parameter setting range, assigning the iron-core saturation coefficients (E2-07 and E2-08) to temporary values.		<ul style="list-style-type: none"> • Check and correct faulty motor wiring. • Disconnect the motor from machine and perform Rotational Auto-Tuning.
Digital Operator Display		Error Name
<i>End3</i>	End3	Rated Current Setting Alarm (displayed after Auto-Tuning is complete)
Cause		Possible Solutions
The correct current rating printed on the motor nameplate was not entered into T1-04.		<ul style="list-style-type: none"> • Check the setting of parameter T1-04. • Check the motor data and repeat Auto-Tuning.
Digital Operator Display		Error Name
<i>End4</i>	End4	Adjusted Slip Calculation Error
Cause		Possible Solutions
The calculated slip is outside the allowable range.		<ul style="list-style-type: none"> • Make sure the data entered for Auto-Tuning is correct. • If possible, perform Rotational Auto-Tuning. If not possible, perform Stationary Auto-Tuning 2.
Digital Operator Display		Error Name
<i>End5</i>	End5	Resistance Tuning Error
Cause		Possible Solutions
The calculated resistance value is outside the allowable range.		<ul style="list-style-type: none"> • Double-check the data entered for the Auto-Tuning process. • Check the motor and motor cable connection for faults.
Digital Operator Display		Error Name
<i>End6</i>	End6	Leakage Inductance Alarm
Cause		Possible Solutions
The calculated leakage inductance value is outside the allowable range.		Double-check the data entered for the Auto-Tuning process.

5.5 Auto-Tuning Fault Detection

Digital Operator Display		Error Name
End7	End7	No-Load Current Alarm
Cause		Possible Solutions
The entered no-load current value was outside the allowable range.		Check and correct faulty motor wiring.
Auto-Tuning results were less than 5% of the motor rated current.		Double-check the data entered for the Auto-Tuning process.

Digital Operator Display		Error Name
Er-01	Er-01	Motor Data Error
Cause		Possible Solutions
Motor data or data entered during Auto-Tuning was incorrect.		<ul style="list-style-type: none"> Check that the motor data entered to T1 parameters matches motor nameplate input before Auto-Tuning. Restart Auto-Tuning and enter the correct information.
Motor output power and motor-rated current settings (T1-02 and T1-04) do not match.		<ul style="list-style-type: none"> Check the drive and motor capacities. Correct the settings of parameters T1-02 and T1-04.
Motor rated current and detected no-load current are inconsistent.		<ul style="list-style-type: none"> Check the motor rated current and no-load current. Correct the settings of parameters T1-04 and E2-03.

Digital Operator Display		Error Name
Er-02	Er-02	Minor Fault
Cause		Possible Solutions
An alarm was triggered during Auto-Tuning.		Exit the Auto-Tuning menu, check the alarm code, remove the alarm cause, and repeat Auto-Tuning.

Digital Operator Display		Error Name
Er-03	Er-03	STOP Button Input
Cause		Possible Solutions
Auto-Tuning canceled by pressing STOP button.		Auto-Tuning did not complete properly. Restart Auto-Tuning.

Digital Operator Display		Error Name
Er-04	Er-04	Line-to-Line Resistance Error
Cause		Possible Solutions
Motor data entered during Auto-Tuning was incorrect.		<ul style="list-style-type: none"> Make sure the data entered to the T1 parameters match the information written on the motor nameplate. Restart Auto-Tuning and enter the correct information.
Results from Auto-Tuning are outside the parameter setting range or the tuning process took too long.		Check and correct faulty motor wiring.
Faulty motor cable or cable connection.		

Digital Operator Display		Error Name
Er-05	Er-05	No-Load Current Error
Cause		Possible Solutions
Motor data entered during Auto-Tuning was incorrect.		<ul style="list-style-type: none"> Make sure the data entered to the T1 parameters match the information written on the motor nameplate. Restart Auto-Tuning and enter the correct information.
Results from Auto-Tuning are outside the parameter setting range or the tuning process took too long.		<ul style="list-style-type: none"> Check and correct faulty motor wiring. Perform Rotational Auto-Tuning.
The load was too high during Rotational Auto-tuning.		<ul style="list-style-type: none"> Disconnect the motor from machine and restart Auto-Tuning. If motor and load cannot be uncoupled make sure the load is lower than 30%. If a mechanical brake is installed, make sure it is fully lifted during tuning.

Digital Operator Display		Error Name
Er-08	Er-08	Rated Slip Error
Cause		Possible Solutions
Motor data entered during Auto-Tuning was incorrect.		<ul style="list-style-type: none"> Make sure the data entered to the T1 parameters match the information written on the motor nameplate. Restart Auto-Tuning and enter the correct information.
Results from Auto-Tuning are outside the parameter setting range or the tuning process took too long.		<ul style="list-style-type: none"> Check and correct faulty motor wiring. Perform Rotational Auto-Tuning.
The load was too high during rotational Auto-tuning.		<ul style="list-style-type: none"> Disconnect the motor from machine and restart Auto-Tuning. If motor and load cannot be uncoupled make sure the load is lower than 30%. If a mechanical brake is installed, make sure it is fully lifted during tuning.

Digital Operator Display		Error Name
Er-09	Er-09	Acceleration Error
Cause		Possible Solutions
The motor did not accelerate for the specified acceleration time.		<ul style="list-style-type: none"> Increase the acceleration time (C1-01). Disconnect the machine from the motor if possible.
The load was too high during Rotational Auto-Tuning.		<ul style="list-style-type: none"> Disconnect the motor from machine and restart Auto-Tuning. If motor and load cannot be uncoupled make sure the load is lower than 30%. If a mechanical brake is installed, make sure it is fully lifted during tuning.

Digital Operator Display		Error Name
Er-11	Er-11	Motor Speed Fault
Cause		Possible Solutions
Torque reference is too high.		<ul style="list-style-type: none"> Increase the acceleration time (C1-01). Disconnect the machine from the motor if possible.

Digital Operator Display		Error Name
Er-12	Er-12	Current Detection Error
Cause		Possible Solutions
One of the motor phases is missing: (U/T1, V/T2, W/T3).		Check motor wiring and correct any problems.
The current exceeded the current rating of the drive.		<ul style="list-style-type: none"> Check motor wiring for a short between motor lines. Close any magnetic contactors used between motors.
The current is too low.		<ul style="list-style-type: none"> Replace the control board or the entire drive. For instructions on replacing the control board, contact Yaskawa or your nearest sales representative.
Attempted Auto-Tuning without motor connected to the drive.		Connect the motor and restart Auto-Tuning.
Current detection signal error.		Replace the control board or the entire drive. For instructions on replacing the control board, contact Yaskawa or your nearest sales representative.

Digital Operator Display		Error Name
Er-13	Er-13	Leakage Inductance Error
Cause		Possible Solutions
Drive was unable to complete tuning for leakage inductance within 300 seconds.		<ul style="list-style-type: none"> Check all wiring and correct any mistakes. Check the motor rated current value written on the motor nameplate and enter the correct value to T1-04.

Digital Operator Display		Error Name
Er-17	Er-17	Reverse Prohibited Error
Cause		Possible Solutions
Drive is prohibited from rotating the motor in reverse while attempting to perform Inertia Tuning.		<ul style="list-style-type: none"> Inertia Auto-Tuning cannot be performed if the drive is restricted from rotating in reverse. Assuming it is acceptable for the application to rotate in reverse, set b1-04 to 0 and then perform Inertia Tuning.

5.6 Copy Function Related Displays

◆ Tasks, Errors, and Troubleshooting

The table below lists the messages and errors that may appear when using the Copy function.

When executing the tasks offered by the Copy function, the operator will indicate the task being performed. When an error occurs, a code appears on the operator to indicate the error. Note that errors related to the Copy function do not trigger a multi-function output terminal that has been set up to close when a fault or alarm occurs. To clear an error, simply press any key on the operator and the error display will disappear.

Table 5.6 lists the corrective action that can be taken when an error occurs.

- Note:**
1. Whenever using the copy function, the drive should be fully stopped.
 2. The drive will not accept a Run command while the Copy function is being executed.
 3. Parameters can only be saved to a drive when the voltage class, capacity, control mode, and software version match.

Table 5.6 Copy Function Task and Error Displays

Digital Operator Display		Task
<i>CoPy</i>	CoPy	Writing Parameter Settings (flashing)
<i>CPyE</i>	CPyE	Error Writing Data
<i>CSEr</i>	CSEr	Copy Unit Error
<i>dFpS</i>	dFPS	Drive Model Mismatch
<i>End</i>	End	Task Complete
<i>iFEr</i>	iFEr	Communication Error
<i>ndAT</i>	ndAT	Model, Voltage Class, Capacity Mismatch
<i>rdEr</i>	rdEr	Error Reading Data
<i>rEAd</i>	rEAd	Reading Parameter Settings (flashing)
<i>vAEr</i>	vAEr	Voltage Class, Capacity Mismatch
<i>vFyE</i>	vFyE	Parameter settings in the drive and those saved to the copy function are not the same
<i>vrFy</i>	vrFy	Comparing Parameter Settings (flashing)

◆ Fault Reset Methods

When a fault occurs, the cause of the fault must be removed and the drive must be restarted. The table below lists the different ways to restart the drive.

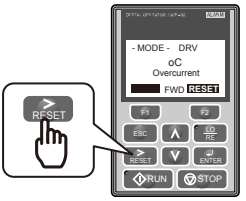
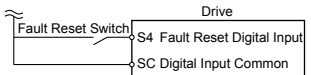
After the Fault Occurs	Procedure	
Fix the cause of the fault, restart the drive, and reset the fault	Press  on the digital operator when the error code is displayed.	
Resetting via Fault Reset Digital Input S4	Close then open the fault signal digital input via terminal S4. S4 is set for "Fault Reset" as default (H1-04 = 14).	

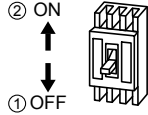
After the Fault Occurs	Procedure
<p>Turn off the main power supply if the above methods do not reset the fault. Reapply power after the digital operator display has turned off.</p>	

Note: If the Run command is present, the drive will disregard any attempts to reset the fault. Remove the Run command before attempting to clear a fault situation.

This Page Intentionally Blank

Periodic Inspection & Maintenance

This chapter describes the periodic inspection and maintenance of the drive to ensure that it receives the proper care to maintain overall performance.

6.1	INSPECTION.....	150
6.2	PERIODIC MAINTENANCE.....	153
6.3	DRIVE REPLACEMENT.....	155

6.1 Inspection

Power electronics have limited life and may exhibit changes in characteristics or performance deterioration after years of use under normal conditions. To help avoid such problems, it is important to perform preventive maintenance and periodic inspection on the drive.

Drives contain a variety of power electronics such as power transistors, semiconductors, capacitors, resistors, fans, and relays. The electronics in the drive serve a critical role in maintaining proper motor control.

Follow the inspection lists provided in this chapter as a part of a regular maintenance program.

Note: The drive will require more frequent inspection if it is placed in harsh environments, such as:

- High ambient temperatures
- Frequent starting and stopping
- Fluctuations in the AC supply or load
- Excessive vibrations or shock loading
- Dust, metal dust, salt, sulfuric acid, chlorine atmospheres
- Poor storage conditions.

Perform the first equipment inspection one to two years after installation.

◆ Recommended Daily Inspection

Table 6.1 outlines the recommended daily inspection for Yaskawa drives. Check the following items on a daily basis to avoid premature deterioration in performance or product failure. Copy this checklist and mark the “Checked” column after each inspection.

Table 6.1 General Recommended Daily Inspection Checklist

Inspection Category	Inspection Points	Corrective Action	Checked
Motor	Inspect for abnormal oscillation or noise coming from the motor.	<ul style="list-style-type: none"> • Check the load coupling. • Measure motor vibration. • Tighten all loose components. 	
Cooling	Inspect for abnormal heat generated from the drive or motor and visible discoloration.	Check for the following: <ul style="list-style-type: none"> • Excessive load. • Loose connections. • Dirty heatsink or motor. • Ambient temperature. 	
	Inspect drive cooling fan and circulation fan operation.	Check for the following: <ul style="list-style-type: none"> • Clogged or dirty fan. • Correct Fan operation parameter setting. 	
Environment	Verify the drive environment complies with the specifications listed in <i>Installation Environment</i> on page 26.	Eliminate the source of contaminants or correct poor environment.	
Load	The drive output current should not be higher than the motor or drive rating for an extended period of time.	Check for the following: <ul style="list-style-type: none"> • Excessive load. • Correct motor parameter settings. 	
Power Supply Voltage	Check main power supply and control voltages.	<ul style="list-style-type: none"> • Correct the voltage or power supply to within nameplate specifications. • Verify all main circuit phases. 	

◆ Recommended Periodic Inspection

Table 6.2 outlines the recommended periodic inspections for Yaskawa drive installations. Although periodic inspections should generally be performed once a year; the drive may require more frequent inspection in harsh environments or with rigorous use. Operating and environmental conditions, along with experience in each application, will determine the actual inspection frequency for each installation. Periodic inspection will help to avoid premature deterioration in performance or product failure. Copy this checklist and mark the “Checked” column after each inspection.

■ Periodic Inspection

WARNING! Electrical Shock Hazard. Do not inspect, connect, or disconnect any wiring while the power is on. Failure to comply can result in serious personal injury. Before servicing, disconnect all power to the equipment. The internal capacitor remains charged even after the power supply is turned off. The charge indicator LED will extinguish when the DC bus voltage is below 50 Vdc. To prevent electric shock, wait for at least the time specified on the warning label; after all indicators are OFF, measure for unsafe voltages to confirm the drive is safe prior to servicing.

Table 6.2 Periodic Inspection Checklist

Inspection Area	Inspection Points	Corrective Action	Checked
Main Circuit Periodic Inspection			
General	<ul style="list-style-type: none"> Inspect equipment for discoloration from overheating or deterioration. Inspect for damaged or deformed parts. 	<ul style="list-style-type: none"> Replace damaged components as required. The drive has few serviceable parts and may require complete drive replacement. 	
	Inspect for dirt, foreign particles, or dust collection on components.	<ul style="list-style-type: none"> Inspect enclosure door seal if used. Use dry air to clear away foreign matter. Use a pressure of 39.2×10^4 to 58.8×10^4 Pa (4 - 6 kg•cm²) (57 to 85 psi). Replace components if cleaning is not possible. 	
Conductors and Wiring	<ul style="list-style-type: none"> Inspect wiring and connections for discoloration, damage, or heat stress. Inspect wire insulation and shielding for wear. 	Repair or replace damaged wiring.	
Terminals	Inspect terminals for stripped, damaged, or loose connections.	Tighten loose screws and replace damaged screws or terminals.	
Relays and Contactors	<ul style="list-style-type: none"> Inspect contactors and relays for excessive noise during operation. Inspect coils for signs of overheating such as melted or cracked insulation. 	<ul style="list-style-type: none"> Check coil voltage for overvoltage or undervoltage conditions. Replace damaged removable relays, contactors, or circuit board. 	
Braking Resistors	Inspect for discoloration of heat stress on or around resistors.	<ul style="list-style-type: none"> Minor discoloration may be acceptable. Check for loose connections if discoloration exists. 	
Electrolytic Capacitor	<ul style="list-style-type: none"> Inspect for leaking, discoloration, or cracks. Check if the cap has come off, for any swelling, or if the sides have burst open. 	The drive has few serviceable parts and may require complete drive replacement.	
Diode, IGBT (Power Transistor)	Inspect for dust or other foreign material collected on the surface.	Use dry air to clear away foreign matter. Use a pressure of 39.2×10^4 to 58.8×10^4 Pa (4 - 6 kg•cm ²) (57 to 85 psi).	
Motor Periodic Inspection			
Operation Check	Check for increased vibration or abnormal noise.	Stop the motor and contact qualified maintenance personnel as required.	
Control Circuit Periodic Inspection			
General	<ul style="list-style-type: none"> Inspect terminals for stripped, damaged, or loose connections. Make sure all terminals have been properly tightened. 	<ul style="list-style-type: none"> Tighten loose screws and replace damaged screws or terminals. If terminals are integral to a circuit board, then board or drive replacement may be required. 	
	Check for any odor, discoloration, and rust. Make sure connections are properly fastened and that no dust or oil mist has accumulated on the surface of the board.	<ul style="list-style-type: none"> Fix any loose connections. If an antistatic cloth or vacuum plunger cannot be used, replace the board. Do not use any solvents to clean the board. Use dry air to clear away foreign matter. Use a pressure of 39.2×10^4 to 58.8×10^4 Pa (4 - 6 kg•cm²) (57 to 85 psi). The drive has few serviceable parts and may require complete drive replacement.	

6.1 Inspection

Inspection Area	Inspection Points	Corrective Action	Checked
Cooling System Periodic Inspection			
Cooling Fan, Circulation Fan, Control Board Cooling Fan	<ul style="list-style-type: none"> • Check for abnormal oscillation or unusual noise. • Check for damaged or missing fan blades. 	Replace as required.	
Heatsink	Inspect for dust or other foreign material collected on the surface.	Use dry air to clear away foreign matter. Use a pressure of 39.2×10^4 to 58.8×10^4 Pa (4 - 6 kg•cm ²) (57 to 85 psi).	
Air Duct	Inspect air intake and exhaust openings. They must be free from obstruction and properly installed.	<ul style="list-style-type: none"> • Visually inspect the area. • Clear obstructions and clean air duct as required. 	
Display Periodic Inspection			
Digital Operator	<ul style="list-style-type: none"> • Make sure data appears on the display properly. • Inspect for dust or other foreign material that may have collected on surrounding components. 	<ul style="list-style-type: none"> • Contact the nearest sales office if there is any trouble with the display or keypad. • Clean the digital operator. 	

6.2 Periodic Maintenance

The drive has Maintenance Monitors that keep track of component wear. This feature provides advance maintenance warning and eliminates the need to shut down the entire system for unexpected problems. The drive allows the user to check predicted maintenance periods for the components listed below.

- Cooling Fan, Circulation Fan, Control Board Cooling Fan
- Electrolytic Capacitors
- Inrush Prevention Circuit
- IGBTs

For replacement parts, contact the distributor where the drive was purchased or contact Yaskawa directly.

◆ Replacement Parts

Table 6.3 contains the estimated performance life of components that require replacement during the life of the drive. Only use Yaskawa replacement parts for the appropriate drive model and revision.

Table 6.3 Estimated Performance Life

Component	Estimated Performance Life
Cooling Fan, Circulation Fan	10 years
Electrolytic Capacitors	10 years <I>

<I> The drive has few serviceable parts and may require complete drive replacement.

NOTICE: *Estimated performance life based on specific usage conditions. These conditions are provided for the purpose of replacing parts to maintain performance. Some parts may require more frequent replacement due to poor environments or rigorous use.*

Usage conditions for estimated performance life:

Ambient temperature: Yearly average of 40 °C (IP00/Open Type enclosure)

Load factor: 80% maximum

Operation time: 24 hours a day

■ Performance Life Monitors Maintenance Monitors

The drive calculates the maintenance period for components that may require replacement during the life of the drive. A percentage of the maintenance period is displayed on the digital operator by viewing the appropriate monitor parameter.

When the maintenance period reaches 100%, there is increased risk that the drive may malfunction. Yaskawa recommends checking the maintenance period regularly to ensure maximum performance life.

Refer to Recommended Periodic Inspection on page 151 for more details.

Table 6.4 Performance Life Monitors Used for Component Replacement

Parameter	Component	Contents
U4-03	Cooling Fan Circulation Fan	Displays the accumulated operation time of the fan from 0 to 99999 hours. This value is automatically reset to 0 after it reaches 99999.
U4-04	Control Board Cooling Fan	Displays the accumulated fan operation time as a percentage of the specified maintenance period.
U4-05	DC Bus Capacitors	Displays the accumulated time the capacitors are used as a percentage of the specified maintenance period.
U4-06	Inrush (pre-charge) Relay	Displays the number of times the drive is powered up as a percentage of the performance life of the inrush circuit.
U4-07	IGBT	Displays the percentage of the maintenance period reached by the IGBTs.

6.2 Periodic Maintenance

■ Alarm Outputs for Maintenance Monitors

An output can be set up to inform the user when a specific components has neared its expected performance life.

When one of multi-function digital output terminals has been assigned the maintenance monitor function (H2-□□ = 2F), the terminal will close when the cooling fan, DC bus capacitors, or DC bus pre-charge relay reach 90% of the expected performance life, or when the IGBTs have reached 50% of their expected performance life. Additionally the digital operator will display an alarm like shown in [Table 6.5](#) to indicate the specific components that may need maintenance.

Table 6.5 Maintenance Alarms

Digital Operator Alarm Display		Function	Corrective Action
LT-1 <1>	LT-1	The cooling fans have reached 90% of their designated life time.	Replace the cooling fan.
LT-2 <1>	LT-2	The DC bus capacitors have reached 90% of their designated life time.	Contact a Yaskawa representative or the nearest Yaskawa sales office on possible drive replacement.
LT-3 <1>	LT-3	The DC bus charge circuit has reached 90% of its designated life time.	Contact a Yaskawa representative or the nearest Yaskawa sales office on possible drive replacement.
LT-4 <1>	LT-4	The IGBTs have reached 50% of their designated life time.	Check the load, carrier frequency, and output frequency.
TrPC <2>	TrPC	The IGBTs have reached 90% of their designated life time.	Contact a Yaskawa representative or the nearest Yaskawa sales office on possible drive replacement.

<1> This alarm message will be output only if the Maintenance Monitor function is assigned to one of the digital outputs (H2-□□ = 2F). The alarm will also trigger a digital output that is programmed for alarm indication (H2-□□ = 10).

<2> This alarm message will always be output, even if the Maintenance Monitor function is not assigned to any of the digital outputs (H2-□□ = 2F). The alarm will also trigger a digital output that is programmed for alarm indication (H2-□□ = 10).

■ Related Drive Parameters

Use parameters o4-03, o4-05, o4-07, and o4-09 to reset a Maintenance Monitor to zero after replacing a specific component. [Refer to Parameter List on page 177](#) for details on parameter settings.

NOTICE: *If these parameters are not reset after the corresponding parts have been replaced, the Maintenance Monitor function will continue to count down the performance life from the value that was reached with the old part. If the Maintenance Monitor is not reset, the drive will not have the correct value of the performance life for the new component.*

6.3 Drive Replacement

◆ Replacing the Drive

WARNING! Electrical Shock Hazard. Do not connect or disconnect wiring while the power is on. Failure to comply can result in serious personal injury. Before servicing the drive, disconnect all power to the equipment. The internal capacitor remains charged even after the power supply is turned off. After shutting off the power, wait for at least the amount of time specified on the drive before touching any components.

WARNING! Electrical Shock Hazard. Do not allow unqualified personnel to perform work on the drive. Failure to comply could result in serious injury. Installation, maintenance, inspection and servicing must be performed only by authorized personnel familiar with installation, adjustment and maintenance of AC drives.

NOTICE: Observe proper electrostatic discharge procedures (ESD) when handling the drive and circuit boards. Failure to comply may result in ESD damage to the drive circuitry.

The following procedure explains how to replace a drive.

This section provides instructions for drive replacement only.

To install option boards or other types of options, refer to the specific manuals for those options.

NOTICE: When transferring a braking transistor, braking resistor, or other type of option from a damaged drive to a new replacement drive, make sure it is working properly before reconnecting it to the new drive. Replace broken options to prevent immediate breakdown of the replacement drive.

1. Remove the terminal cover.

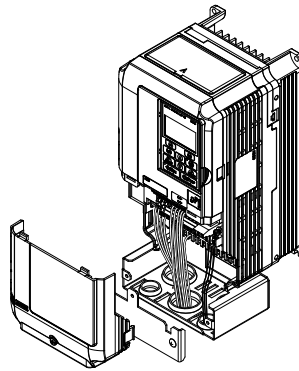

Figure 6.1 Remove the Terminal Cover

2. Loosen the screws holding the terminal board in place. Remove the screw securing the bottom cover and remove the bottom cover from the drive.

Note: IP00/Open Type enclosure drives do not have a bottom cover or conduit.

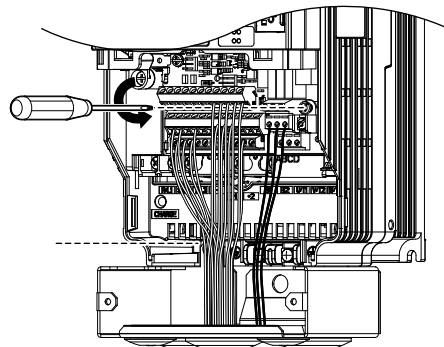

Figure 6.2 Unscrew the Terminal Board and Remove the Bottom Cover

3. Slide the terminal board as illustrated by the arrows to remove it from the drive along with the bottom cover.

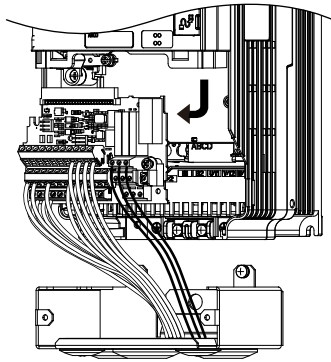

Figure 6.3 Remove the Terminal Board

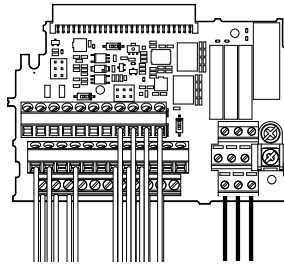

Figure 6.4 Disconnected Removable Terminal Board

4. Disconnect all option cards and options, making sure they are intact before reusing.
5. Replace the drive and wire the main circuit.

■ Installing the Drive

1. After wiring the main circuit, connect the terminal block to the drive as shown in [Figure 6.5](#). Use the installation screw to fasten the terminal block into place.

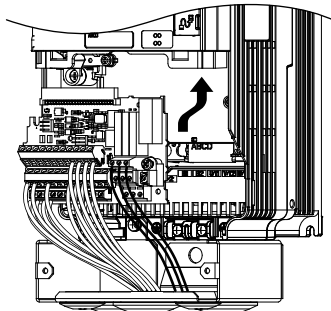

Figure 6.5 Install the Terminal Board

2. Reconnect options for the new drive the same way the options were connected in the old drive. Connect option boards to the same option ports in the new drive that were used in the old drive.
3. Replace the terminal cover.
4. After powering on the drive, all parameter settings are transferred from the terminal board to the drive memory. If an oPE04 error occurs, load the parameter settings saved on the terminal board to the new drive by setting parameter A1-03 to 5550. Reset the Maintenance Monitor function timers by setting parameters o4-01 through o4-12 to 0, and parameter o4-13 to 1.

Peripheral Devices & Options

This chapter explains option installation procedures for the drive.

7.1	OPTION CARD INSTALLATION.....	158
------------	--------------------------------------	------------

7.1 Option Card Installation

This section provides instructions on installing option cards.

◆ Prior to Installing the Option

Prior to installing the option, wire the drive, make necessary connections to the drive terminals, and verify that the drive functions normally without the option installed.

Table 7.1 below lists the number of options that can be connected to the drive and the drive ports for connecting those options.

Table 7.1 Option Installation

Option	Port/Connector	Number of Options Possible
SI-B3, SI-EN3, SI-EM3, SI-N3, SI-P3, SI-T3, SI-C3, SI-S3	CN5-A	1
AO-A3	CN5-A, B, C	1

Figure 7.1 shows an exploded view of the drive with the option and related components for reference.

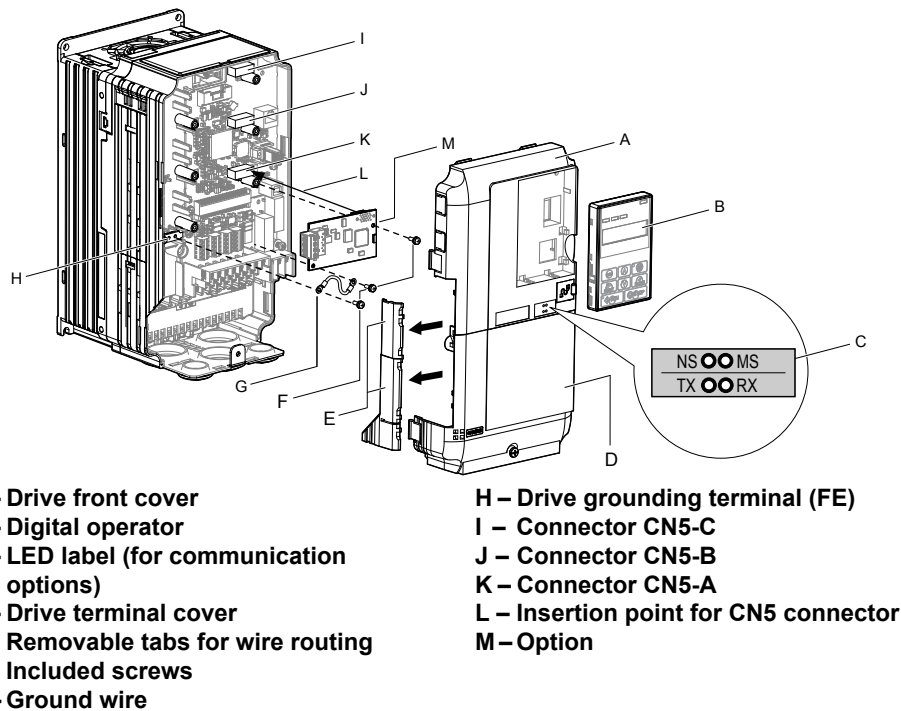

Figure 7.1 Drive Components with Option

◆ Communication Option Installation Example

Remove the front covers of the drive before installing the option. Communication options can be inserted only into the CN5-A connector located on the drive control board.

Preparing the Drive

1. Shut off power to the drive, wait the appropriate amount of time for voltage to dissipate, then remove the digital operator (B) and front covers (A, D). Front cover removal varies by model.

DANGER! Electrical Shock Hazard. Do not connect or disconnect wiring while the power is on. Failure to comply will result in death or serious injury. Before installing the option, disconnect all power to the drive. The internal capacitor remains charged even after the power supply is turned off. The charge indicator LED will extinguish when the DC bus voltage is below 50 Vdc. To prevent electric shock, wait at least five minutes after all indicators are off and measure the DC bus voltage level to confirm safe level.

NOTICE: Damage to Equipment. Observe proper electrostatic discharge procedures (ESD) when handling the option, drive, and circuit boards. Failure to comply may result in ESD damage to circuitry.

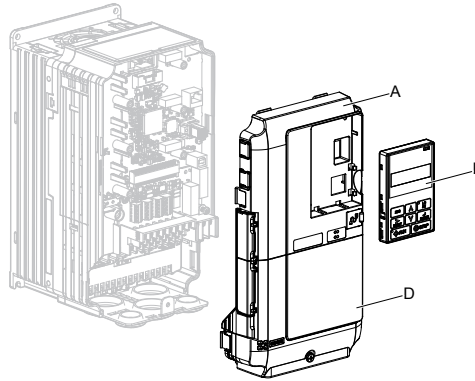

Figure 7.2 Remove the Front Covers and Digital Operator

2. With the front covers and digital operator removed, apply the LED label (C) in the appropriate position on the drive top front cover (A).

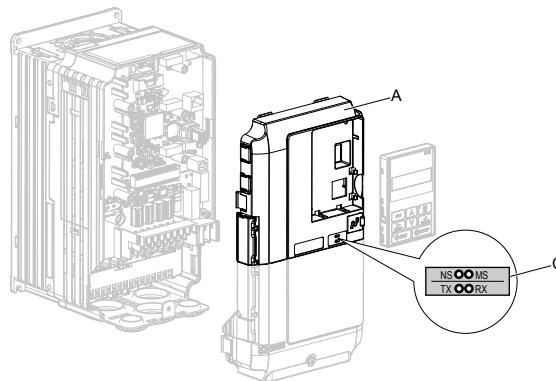

Figure 7.3 Apply the LED Label

Connecting Option and Ground Wire

1. Insert the option (M) into the **CN5-A** connector (K) located on the drive and fasten it using one of the included screws (F).

7.1 Option Card Installation

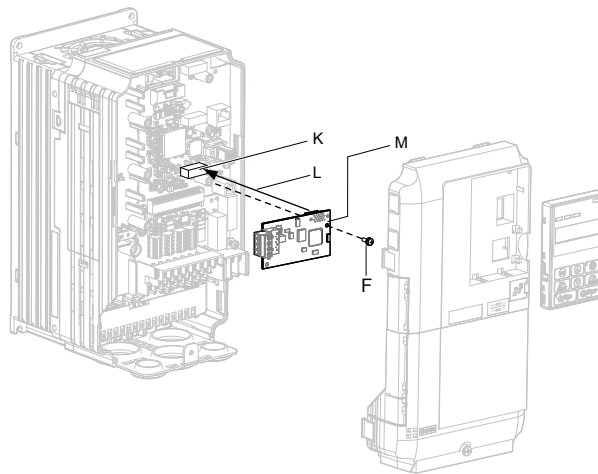

Figure 7.4 Insert the Option

2. Connect the ground wire (G) to the ground terminal (H) using one of the remaining provided screws (F). Connect the other end of the ground wire (G) to the remaining ground terminal and installation hole on the option (M) using the last remaining provided screw (F) and tighten both screws to 0.5 ~ 0.6 N m or (4.4 ~ 5.3 in lbs).

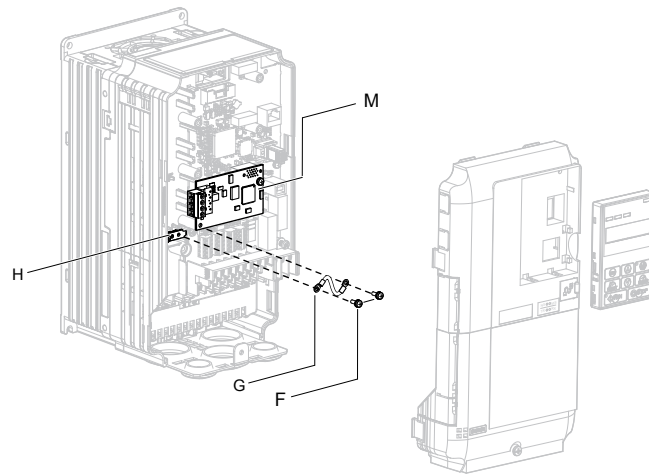

Figure 7.5 Connect the Ground Wire

Note: There are two screw holes on the drive for use as ground terminals. When connecting three options, two ground wires will need to share the same drive ground terminal.

Wiring the Option

1. Route the option wiring.

Depending on the drive model, some drives may require routing the wiring through the side of the front cover to the outside to provide adequate space for the wiring. In these cases, using diagonal cutting pliers, cut out the perforated openings on the left side of the drive front cover. Sharp edges along the cut out should be smoothed down with a file or sand paper to prevent any damage to the wires.

When installing option cards to models 2A0004 to 2A0040, 4A0002 to 4A0023, and 5A0003 to 5A0011, it may be necessary to route the cables connected to the option through the top cover to the outside. Models 2A0056 to 2A0415, 4A0031 to 4A1200, and 5A0017 to 5A0242 have enough space to keep all wiring inside the unit.

2. Connect the communication cables to the option terminal block (TB1).

Note: Separate the communications cables from the main circuit cables and other wiring and power cables. Use properly grounded shielded cables for the communication cables to prevent problems caused by electrical interference.

Replacing the Drive Covers and Digital Operator

1. Replace and secure the front covers of the drive (A, D) and replace the digital operator (B).

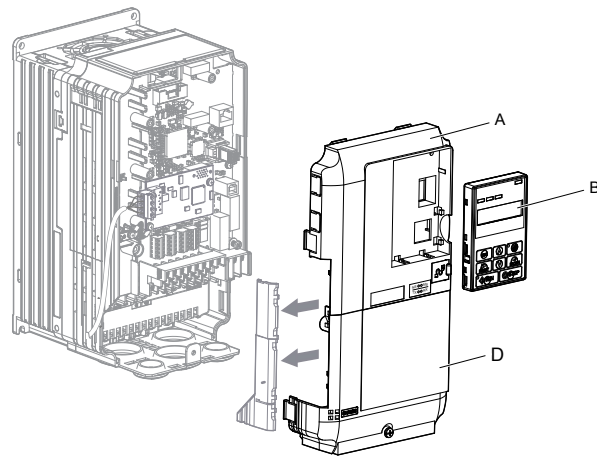

Figure 7.6 Replace the Front Covers and Digital Operator

Note: Take proper precautions when wiring the option so that the front covers will easily fit back onto the drive. Make sure no cables are pinched between the front covers and the drive when replacing the covers.

This Page Intentionally Blank

Appendix: A

Specifications

A.1	POWER RATINGS.....	164
A.2	DRIVE SPECIFICATIONS.....	173
A.3	DRIVE WATT LOSS DATA.....	175

A.1 Power Ratings

◆ Three-Phase 200 V Class Drive Models 2A0004 to 2A0030

Table A.1 Power Ratings (Three-Phase 200 V Class)

Item		Specification								
Drive Model		2A0004	2A0006	2A0008	2A0010	2A0012	2A0018	2A0021	2A0030	
Maximum Applicable Motor Capacity (HP) <1>	ND Rating	0.75	1	2	3	3	5	7.5	10	
	Input Current (A) <2>	3.9	7.3	8.8	10.8	13.9	18.5	24	37	
Input	Rated Voltage Rated Frequency	Three-phase 200 to 240 Vac 50/60 Hz/270 to 340 Vdc <3>								
	Allowable Voltage Fluctuation	-15 to 10%								
	Allowable Frequency Fluctuation	±5%								
	Input Power (kVA)	ND Rating	2.2	3.1	4.1	5.8	7.8	9.5	14	18
Output	Rated Output Capacity (kVA) <4>	ND Rating <5>	1.3	2.3	3	3.7	4.6	6.7	8	11.4
	Rated Output Current (A)	ND Rating <5>	3.5	6	8	9.6	12	17.5	21	30
	Overload Tolerance	ND Rating: 120% of rated output current for 60 s (Derating may be required for applications that start and stop frequently)								
	Carrier Frequency	User adjustable between 2 to 15 kHz								
	Maximum Output Voltage (V)	Three-phase 200 to 240 V (proportional to input voltage)								
Maximum Output Frequency (Hz)	400 Hz (user-set)									

<1> The motor capacity (HP) refers to a NEC rated 4-pole motor. The rated output current of the drive output amps should be equal to or greater than the motor current. Select the appropriate capacity drive if operating the motor continuously above motor nameplate current.

<2> Assumes operation at the rated output current. Input current rating varies depending on the power supply transformer, input reactor, wiring connections, and power supply impedance.

<3> DC is not available for UL/CE standards.

<4> Rated motor capacity is calculated with a rated output voltage of 220 V.

<5> Carrier frequency is set to 2 kHz. Current derating is required in order to raise the carrier frequency.

◆ Three-Phase 200 V Class Drive Models 2A0040 to 2A0211

Table A.2 Power Ratings Continued (Three-Phase 200 V Class)

Item		Specification								
Drive Model		2A0040	2A0056	2A0069	2A0081	2A0110	2A0138	2A0169	2A0211	
Maximum Applicable Motor Capacity (HP) <1>	ND Rating	15	20	25	30	40	50	60	75	
	Input Current (A) <2>	52	68	80	96	111	136	164	200	
Input	Rated Voltage Rated Frequency	Three-phase 200 to 240 Vac 50/60 Hz/270 to 340 Vdc <3>								
	Allowable Voltage Fluctuation	-15 to 10%								
	Allowable Frequency Fluctuation	±5%								
	Input Power (kVA)	ND Rating	27	36	44	52	51	62	75	91
Output	Rated Output Capacity (kVA) <4>	ND Rating <5>	15.2	21	26	31	42	53	64	80
	Rated Output Current (A)	ND Rating <5>	40	56	69	81	110	138	169	211
	Overload Tolerance	ND Rating: 120% of rated output current for 60 s (Derating may be required for applications that start and stop frequently)								
	Carrier Frequency	User adjustable between 2 to 15 kHz						User adjustable between 2 and 10 kHz		
	Maximum Output Voltage (V)	Three-phase 200 to 240 V (proportional to input voltage)								
	Maximum Output Frequency (Hz)	400 Hz (user-set)								

- <1> The motor capacity (HP) refers to a NEC rated 4-pole motor. The rated output current of the drive output amps should be equal to or greater than the motor current. Select the appropriate capacity drive if operating the motor continuously above motor nameplate current.
- <2> Assumes operation at the rated output current. Input current rating varies depending on the power supply transformer, input reactor, wiring connections, and power supply impedance.
- <3> DC is not available for UL/CE standards.
- <4> Rated motor capacity is calculated with a rated output voltage of 220 V.
- <5> Carrier frequency is set to 2 kHz. Current derating is required in order to raise the carrier frequency.

◆ Three-Phase 200 V Class Drive Models 2A0250 to 2A0415

Table A.3 Power Ratings Continued (Three-Phase 200 V Class)

Item		Specification			
Drive Models		2A0250	2A0312	2A0360	2A0415
Maximum Applicable Motor Capacity (HP) <1>		100	125	150	175
Input Current (A) <2>		271	324	394	471
Input	Rated Voltage Rated Frequency	Three-phase 200 to 240 Vac 50/60 Hz/270 to 340 Vdc <3>			
	Allowable Voltage Fluctuation	-15 to 10%			
	Allowable Frequency Fluctuation	±5%			
	Input Power (kVA)	124	148	180	215
Rated Output Capacity (kVA) <4>		95	119	137	158
Rated Output Current (A)		250	312	360	415
Output	Overload Tolerance	ND Rating: 120% of rated output current for 60 s (Derating may be required for applications that start and stop frequently)			
	Carrier Frequency	User adjustable between 2 to 10 kHz			
	Maximum Output Voltage (V)	Three-phase 200 to 240 V (proportional to input voltage)			
	Maximum Output Frequency (Hz)	400 Hz (user-set)			

- <1> The motor capacity (HP) refers to a NEC rated 4-pole motor. The rated output current of the drive output amps should be equal to or greater than the motor current. Select the appropriate capacity drive if operating the motor continuously above motor nameplate current.
- <2> Assumes operation at the rated output current. Input current rating varies depending on the power supply transformer, input reactor, wiring connections, and power supply impedance.
- <3> DC is not available for UL/CE standards.
- <4> Rated motor capacity is calculated with a rated output voltage of 220 V.
- <5> Carrier frequency is set to 2 kHz. Current derating is required in order to raise the carrier frequency.

◆ Three-Phase 400 V Class Drive Models 4A0002 to 4A0031

Table A.4 Power Ratings (Three-Phase 400 V Class)

Item		Specification									
Drive Models		4A0002	4A0004	4A0005	4A0007	4A0009	4A0011	4A0018	4A0023	4A0031	
Maximum Applicable Motor Capacity (HP) <1>	ND Rating	0.75	2	3	3	5	7.5	10	15	20	
	Input Current (A) <2>	2.1	4.3	5.9	8.1	9.4	14	20	24	38	
Input	Rated Voltage Rated Frequency	Three-phase: 380 to 480 Vac 50/60 Hz/510 to 680 Vdc <3>									
	Allowable Voltage Fluctuation	-15 to 10%									
	Allowable Frequency Fluctuation	±5%									
	Input Power (kVA)	ND Rating	2.3	4.3	6.1	8.1	10.0	14.5	19.4	28.4	37.5
Output	Rated Output Capacity (kVA) <4>	ND Rating <5>	1.6	3.1	4.1	5.3	6.7	8.5	13.3	17.5	24
	Rated Output Current (A)	ND Rating <5>	2.1	4.1	5.4	6.9	8.8	11.1	17.5	23	31
	Overload Tolerance	ND Rating: 120% of rated output current for 60 s (Derating may be required for applications that start and stop frequently)									
	Carrier Frequency	User adjustable between 2 to 15 kHz									
	Maximum Output Voltage (V)	Three-phase: 380 to 480 V (proportional to input voltage)									
Maximum Output Frequency (Hz)	400 Hz (user-adjustable)										

- <1> The motor capacity (HP) refers to a NEC rated 4-pole motor. The rated output current of the drive output amps should be equal to or greater than the motor current. Select the appropriate capacity drive if operating the motor continuously above motor nameplate current.
- <2> Assumes operation at the rated output current. Input current rating varies depending on the power supply transformer, input reactor, wiring conditions, and power supply impedance.
- <3> DC is not available for UL/CE standards.
- <4> Rated motor capacity is calculated with a rated output voltage of 440 V.
- <5> Carrier frequency is set to 2 kHz. Current derating is required in order to raise the carrier frequency.

◆ Three-Phase 400 V Class Drive Models 4A0038 to 4A0165

Table A.5 Power Ratings Continued (Three-Phase 400 V Class)

Item		Specification								
Drive Models		4A0038	4A0044	4A0058	4A0072	4A0088	4A0103	4A0139	4A0165	
Maximum Applicable Motor Capacity (HP) <1>	ND Rating	25	30	40	50	60	75	100	125	
	Input Current (A) <2>	44	52	58	71	86	105	142	170	
Input	Rated Voltage Rated Frequency	Three-phase: 380 to 480 Vac 50/60 Hz/510 to 680 Vdc <3>								
	Allowable Voltage Fluctuation	-15 to 10%								
	Allowable Frequency Fluctuation	±5%								
	Input Power (kVA)	ND Rating	46.6	54.9	53.0	64.9	78.6	96.0	130	156
Output	Rated Output Capacity (kVA) <4>	ND Rating <5>	29	34	44	55	67	78	106	126
	Rated Output Current (A)	ND Rating <5>	38	44	58	72	88	103	139	165
	Overload Tolerance	ND Rating: 120% of rated output current for 60 s (Derating may be required for applications that start and stop frequently)								
	Carrier Frequency	User adjustable between 2 to 15 kHz						User adjustable between 2 to 10 kHz		
	Maximum Output Voltage (V)	Three-phase: 380 to 480 V (proportional to input voltage)								
Maximum Output Frequency (Hz)	400 Hz (user-adjustable)									

- <1> The motor capacity (HP) refers to a NEC rated 4-pole motor. The rated output current of the drive output amps should be equal to or greater than the motor current. Select the appropriate capacity drive if operating the motor continuously above motor nameplate current.
- <2> Assumes operation at the rated output current. Input current rating varies depending on the power supply transformer, input reactor, wiring conditions, and power supply impedance.
- <3> DC is not available for UL/CE standards.
- <4> Rated motor capacity is calculated with a rated output voltage of 440 V.
- <5> Carrier frequency is set to 2 kHz. Current derating is required in order to raise the carrier frequency.

◆ Three-Phase 400 V Class Drive Models 4A0208 to 4A0675

Table A.6 Power Ratings Continued (Three-Phase 400 V Class)

Item		Specification							
Drive Models		4A0208	4A0250	4A0296	4A0362	4A0414	4A0515	4A0675	
Maximum Applicable Motor Capacity (HP) <1>	ND Rating	150	200	250	300	350	400-450	500-550	
Input	Input Current (A) <2>	207	248	300	346	410	465	657	
	Rated Voltage Rated Frequency	Three-phase: 380 to 480 Vac 50/60 Hz/510 to 680 Vdc <3>							
	Allowable Voltage Fluctuation	-15 to 10%							
	Allowable Frequency Fluctuation	±5%							
	Input Power (kVA)	ND Rating	189	227	274	316	375	425	601
Output	Rated Output Capacity (kVA) <4>	ND Rating <5>	159	191	226	276	316	392	514
	Rated Output Current (A)	ND Rating <5>	208	250	296	362	414	515	675
	Overload Tolerance	ND Rating: 120% of rated output current for 60 s (Derating may be required for applications that start and stop frequently)							
	Carrier Frequency	User-adjustable between 2 and 10 kHz				User-adjustable between 2 and 5 kHz			
	Maximum Output Voltage (V)	Three-phase: 380 to 480 V (proportional to input voltage)							
Maximum Output Frequency (Hz)	400 Hz (user-adjustable)								

- <1> The motor capacity (HP) refers to a NEC rated 4-pole motor. The rated output current of the drive output amps should be equal to or greater than the motor current. Select the appropriate capacity drive if operating the motor continuously above motor nameplate current.
- <2> Assumes operation at the rated output current. Input current rating varies depending on the power supply transformer, input reactor, wiring conditions, and power supply impedance.
- <3> DC is not available for UL/CE standards.
- <4> Rated motor capacity is calculated with a rated output voltage of 440 V.
- <5> Carrier frequency is set to 2 kHz. Current derating is required in order to raise the carrier frequency.

◆ Three-Phase 600 V Class Drive Models 5A0003 to 5A0032

Table A.7 Power Ratings (Three-Phase 600 V Class)

Item		Specification										
Drive Models		5A0003	5A0004	5A0006	5A0009	5A0011	5A0017	5A0022	5A0027	5A0032		
Input	Maximum Applicable Motor Capacity (HP) <1>	ND Rating	2	3	5	7.5	10	15	20	25	30	
	Input Current (A) <2>	ND Rating	3.6	5.1	8.3	12	16	23	31	38	45	
	Rated Voltage Rated Frequency		Three-phase 500 to 600 Vac 50/60 Hz									
	Allowable Voltage Fluctuation		-10 (-15) to +10%									
	Allowable Frequency Fluctuation		±5%									
Output	Input Power (kVA)	ND Rating	4.1	5.8	9.5	14	18	26	35	43	51	
	Rated Output Capacity (kVA) <3>	ND Rating <4>	2.7	3.9	6.1	9	11	17	22	27	32	
	Rated Output Current (A)	ND Rating <4>	2.7	3.9	6.1	9	11	17	22	27	32	
	Overload Tolerance		ND Rating: 120% of rated output current for 60 s (Derating may be required for applications that start and stop frequently)									
	Carrier Frequency		User adjustable between 2 and 15 kHz					User adjustable between 2 and 10 kHz				
	Maximum Output Voltage (V)		Three-phase 500 to 600 V (proportional to input voltage)									
Maximum Output Frequency (Hz)		400 Hz (user-set)										

<1> The motor capacity (HP) refers to a NEC rated 4-pole motor. The rated output current of the drive output amps should be equal to or greater than the motor current. Select the appropriate capacity drive if operating the motor continuously above motor nameplate current.

<2> Assumes operation at the rated output current. Input current rating varies depending on the power supply transformer, input reactor, wiring connections, and power supply impedance.

<3> Rated motor capacity is calculated with a rated output voltage of 575 V.

<4> Carrier frequency is set to 2 kHz. Current derating is required to raise the carrier frequency.

◆ Three-Phase 600 V Class Drive Models 5A0041 to 5A0099

Table A.8 Power Ratings Continued (Three-Phase 600 V Class)

Item		Specification				
Drive Models		5A0041	5A0052	5A0062	5A0077	5A0099
Maximum Applicable Motor Capacity (HP) <1>		40	50	60	75	100
ND Rating						
Input	Input Current (A) <2>	44	54	66	80	108
	ND Rating					
	Rated Voltage Rated Frequency	Three-phase 500 to 600 Vac 50/60 Hz				
	Allowable Voltage Fluctuation	-10 (-15) to +10%				
	Allowable Frequency Fluctuation	±5%				
Input Power (kVA)	ND Rating	50	62	75	91	123
ND Rating						
Output	Rated Output Capacity (kVA) <3>	41	52	62	77	99
	ND Rating <4>					
	Rated Output Current (A)	41	52	62	77	99
	ND Rating <4>					
	Overload Tolerance	ND Rating: 120% of rated output current for 60 s (Derating may be required for applications that start and stop frequently)				
	Carrier Frequency	User adjustable between 2 and 10 kHz				User adjustable between 2 and 8 kHz
Maximum Output Voltage (V)	Three-phase 500 to 600 V (proportional to input voltage)					
Maximum Output Frequency (Hz)	400 Hz (user-set)					

- <1> The motor capacity (HP) refers to a NEC rated 4-pole motor. The rated output current of the drive output amps should be equal to or greater than the motor current. Select the appropriate capacity drive if operating the motor continuously above motor nameplate current.
- <2> Assumes operation at the rated output current. Input current rating varies depending on the power supply transformer, input reactor, wiring connections, and power supply impedance.
- <3> Rated motor capacity is calculated with a rated output voltage of 575 V.
- <4> Carrier frequency can be increased to 2 kHz while keeping this current derating. Higher carrier frequency settings require derating.

◆ Three-Phase 600 V Class Drive Models 5A0125 to 5A0242

Table A.9 Power Ratings Continued (Three-Phase 600 V Class)

Item		Specification			
Drive Models		5A0125	5A0145	5A0192	5A0242
Maximum Applicable Motor Capacity (HP) <1>		125	150	200	250
ND Rating					
Input	Input Current (A) <2>	129	158	228	263
	ND Rating				
	Rated Voltage Rated Frequency	Three-phase 500 to 600 Vac 50/60 Hz			
	Allowable Voltage Fluctuation	-10 (-15) to +10%			
	Allowable Frequency Fluctuation	±5%			
Input Power (kVA)	ND Rating	147	181	261	301
ND Rating					
Output	Rated Output Capacity (kVA) <3>	124	144	191	241
	ND Rating <4>				
	Rated Output Current (A)	125	145	192	242
	ND Rating <4>				
	Overload Tolerance	ND Rating: 120% of rated output current for 60 s (Derating may be required for applications that start and stop frequently)			
	Carrier Frequency	User adjustable between 2 and 3 kHz			
Maximum Output Voltage (V)	Three-phase 500 to 600 V (proportional to input voltage)				
Maximum Output Frequency (Hz)	400 Hz (user-set)				

<1> The motor capacity (HP) refers to a NEC rated 4-pole motor. The rated output current of the drive output amps should be equal to or greater than the motor current. Select the appropriate capacity drive if operating the motor continuously above motor nameplate current.

<2> Assumes operation at the rated output current. Input current rating varies depending on the power supply transformer, input reactor, wiring connections, and power supply impedance.

<3> Rated motor capacity is calculated with a rated output voltage of 575 V.

<4> Carrier frequency can be increased to 2 kHz while keeping this current derating. Higher carrier frequency settings require derating.

A.2 Drive Specifications

- Note:**
1. Perform rotational Auto-Tuning to obtain the performance specifications given below.
 2. For optimum performance life of the drive, install the drive in an environment that meets the required specifications.

	Item	Specification
Control Characteristics	Control Method	V/f Control (V/f)
	Frequency Control Range	0.01 to 400 Hz
	Frequency Accuracy (Temperature Fluctuation)	Digital input: within $\pm 0.01\%$ of the max output frequency (-10 to +40 °C) Analog input: within $\pm 0.1\%$ of the max output frequency (25 °C ± 10 °C)
	Frequency Setting Resolution	Digital inputs: 0.01 Hz Analog inputs: 1/2048 of the maximum output frequency setting (11 bit plus sign) Resolution of analog inputs A1 and A3 is 10 bit + sign in current mode
	Output Frequency Resolution	0.001 Hz
	Frequency Setting Signal	Main speed frequency reference: DC -10 to +10 V (20 k Ω), DC 0 to +10 V (20 k Ω), 4 to 20 mA (250 Ω), 0 to 20 mA (250 Ω) Main speed reference: Pulse train input (max. 32 kHz)
	Starting Torque <1>	V/f: 150% at 3 Hz
	Speed Control Range <1>	V/f: 1:40
	Accel/Decel Time	0.0 to 6000.0 s (2 selectable combinations of independent acceleration and deceleration settings)
	Braking Torque	Approx. 20% (approx. 125% when using braking resistor) <2> <ul style="list-style-type: none"> • Short-time decel torque <3> : over 100% for 0.4/ 0.75 kW motors, over 50% for 1.5 kW motors, and over 20% for 2.2 kW and above motors <4> (overexcitation braking/High Slip Braking: approx. 40%) • Continuous regenerative torque: approx. 20% <4> (approx. 125% with dynamic braking resistor option <5> : 10% ED, 10s)
	Braking Transistor	Models 2A0004 to 2A0138, 4A0002 to 4A0072, and 5A0003 to 5A0052 have a built-in braking transistor.
V/f Characteristics	User-selected programs and V/f preset patterns possible	
Main Control Functions	Droop Control, Feed Forward Control, Momentary Power Loss Ride-Thru, Speed Search, Overtorque/Undertorque Detection, Torque Limit, 17 Step Speed (max), Accel/decel Switch, S-curve Accel/decel, 3-wire Sequence, Auto-tuning (rotational, stationary tuning), Dwell, Cooling Fan on/off Switch, Slip Compensation, Torque Compensation, Frequency Jump, Upper/lower Limits for Frequency Reference, DC Injection Braking at Start and Stop, Overexcitation Braking, High Slip Braking, PI Control (with sleep function), Energy Saving Control, MEMOBUS/Modbus Comm. (RS-422/RS-485 max, 115.2 kbps), Fault Restart, Application Presets, Removable Terminal Block with Parameter Backup Function, Online Tuning, KEB, Overexcitation Deceleration, Overvoltage Suppression, High Frequency Injection, Dynamic Noise Control	
Protection Functions	Motor Protection	Electronic thermal overload relay
	Momentary Overcurrent Protection	Drive stops when output current exceeds 170% of rated output current
	Overload Protection	Drive stops when rated output current is 120% for 60 s <5>
	Overvoltage Protection	200 V class: Stops when DC bus voltage exceeds approx. 410 V 400 V class: Stops when DC bus voltage exceeds approx. 820 V 600 V class: Stops when DC bus voltage exceeds approx. 1040 V
	Undervoltage Protection	200 V class: Stops when DC bus voltage falls below approx. 190 V 400 V class: Stops when DC bus voltage falls below approx. 380 V 600 V class: Stops when DC bus voltage falls below approx. 475 V

A.2 Drive Specifications

Item		Specification
Protection Functions	Momentary Power Loss Ride-Thru	Immediately stop after 15 ms or longer power loss <6> . Continuous operation during power loss than 2 s (standard) <7>
	Heatsink Overheat Protection	Thermistor
	Braking Resistor Overheat Protection	Overheat input signal for braking resistor (Optional ERF-type, 3% ED)
	Stall Prevention	Stall Prevention is available during acceleration, deceleration, and during run.
	Ground Protection	Electronic circuit protection <8>
	DC Bus Charge LED	Remains lit until DC bus voltage falls below 50 V
Environment	Area of Use	Indoors
	Ambient Temperature	-10 to +40 °C (IP20/NEMA Type 1 enclosure), -10 to +50 °C (IP00/Open Type enclosure)
	Humidity	95 RH% or less (no condensation)
	Storage Temperature	-20 to +60 °C (short-term temperature during transportation)
	Altitude	Up to 1000 meters without derating, up to 3000 m with output current and voltage derating.
	Vibration/Shock	10 to 20 Hz: 9.8 m/s ² 20 to 55 Hz: 5.9 m/s ² (2A0004 to 2A0211, 4A0002 to 4A0165, and 5A0003 to 5A0099) 2.0 m/s ² (2A0250 to 2A0415, 4A0208 to 4A0675, and 5A0125 to 5A0242)
Safety Standard	UL 508C (Power Conversion), UL/cUL listed, CSA 22.2 No. 14-05 (Industrial Control Equipment), CE marked, RoHS compliant, EN 61800-5-1 (LVD), EN 61800-3 (EMC), IEC60529	
Protection Design	IP00/Open Type enclosure, IP20/NEMA Type 1 enclosure <9>	

- <1> The accuracy of these values depends on motor characteristics, ambient conditions, and drive settings. Specifications may vary with different motors and with changing motor temperature. Contact Yaskawa for consultation.
- <2> Disable Stall Prevention during deceleration (L3-04 = 0) when using a regenerative converter, a regenerative unit, a braking resistor or the Braking Resistor Unit. The default setting for the Stall Prevention function will interfere with the braking resistor.
- <3> Instantaneous average deceleration torque refers to the torque required to decelerate the motor (uncoupled from the load) from the rated motor speed down to zero in the shortest time.
- <4> Actual specifications may vary depending on motor characteristics.
- <5> Overload protection may be triggered when operating with 150% of the rated output current if the output frequency is less than 6 Hz.
- <6> May be shorter due to load conditions and motor speed.
- <7> A separate Momentary Power Loss Ride-Thru Unit is required for models 2A0004 to 2A0056 and 4A0002 to 4A0031 if the application needs to continue running for up to 2 seconds during a momentary power loss.
- <8> Ground protection cannot be provided when the impedance of the ground fault path is too low, or when the drive is powered up while a ground fault is present at the output.
- <9> Removing the top protective cover or bottom conduit bracket from an IP20/NEMA Type 1 enclosure drive voids NEMA Type 1 protection while maintaining IP20 conformity. This is applicable to models 2A0004 to 2A0211, 4A0002 to 4A0165, and 5A0003 to 5A0242.

A.3 Drive Watt Loss Data

Table A.10 Watt Loss 200 V Class Three-Phase Models

Drive Model	Normal Duty			
	Rated Amps (A) <1>	Heatsink Loss (W)	Interior Unit Loss (W)	Total Loss (W)
2A0004	3.5	18.4	47	66
2A0006	6.0	31	51	82
2A0008	8.0	43	52	95
2A0010	9.6	57	58	115
2A0012	12.0	77	64	141
2A0018	17.5	101	67	168
2A0021	21	138	83	222
2A0030	30	262	117	379
2A0040	40	293	145	437
2A0056	56	371	175	546
2A0069	69	491	205	696
2A0081	81	527	257	785
2A0110	110	719	286	1005
2A0138	138	842	312	1154
2A0169	169	1014	380	1394
2A0211	211	1218	473	1691
2A0250	250	1764	594	2358
2A0312	312	2020	665	2686
2A0360	360	2698	894	3591
2A0415	415	2672	954	3626

<1> Value assumes the carrier frequency is set to 2 kHz.

Table A.11 Watt Loss 400 V Class Three-Phase Models

Drive Model	Normal Duty			
	Rated Amps (A) <1>	Heatsink Loss (W)	Interior Unit Loss (W)	Total Loss (W)
4A0002	2.1	20	48	68
4A0004	4.1	32	49	81
4A0005	5.4	45	53	97
4A0007	6.9	62	59	121
4A0009	8.8	66	60	126
4A0011	11.1	89	73	162
4A0018	17.5	177	108	285
4A0023	23	216	138	354
4A0031	31	295	161	455
4A0038	38	340	182	521
4A0044	44	390	209	599
4A0058	58	471	215	686
4A0072	72	605	265	870
4A0088	88	684	308	993
4A0103	103	848	357	1205
4A0139	139	1215	534	1749
4A0165	165	1557	668	2224
4A0208	208	1800	607	2408
4A0250	250	2379	803	3182
4A0296	296	2448	905	3353
4A0362	362	3168	1130	4298

A.3 Drive Watt Loss Data

Drive Model	Normal Duty			
	Rated Amps (A) <1>	Heatsink Loss (W)	Interior Unit Loss (W)	Total Loss (W)
4A0414	414	3443	1295	4738
4A0515	515	4850	1668	6518
4A0675	675	4861	2037	6898

<1> Value assumes the carrier frequency is set to 2 kHz.

Table A.12 Watt Loss Three-Phase 600 V Class Three-Phase Models

Drive Model	Normal Duty			
	Rated Amps (A) <1>	Heatsink Loss (W)	Interior Unit Loss (W)	Total Loss (W)
5A0003	2.7	21.5	23.3	44.8
5A0004	3.9	27.5	33.6	61.1
5A0006	6.1	28.1	43.7	71.8
5A0009	9.0	43.4	68.9	112.3
5A0011	11	56.1	88.0	144.0
5A0017	17	96.6	146.7	243.2
5A0022	22	99.4	178.3	277.7
5A0027	27	132.1	227.2	359.3
5A0032	32	141.6	279.9	421.5
5A0041	41	330.8	136.2	467.0
5A0052	52	427.8	166.2	594.0
5A0062	62	791.2	279.0	1070.2
5A0077	77	959.1	329.4	1288.6
5A0099	99	1253.2	411.7	1664.9
5A0125	125	1641	537	2178
5A0145	145	1860	603	2463
5A0192	192	2420	769	3189
5A0242	242	3100	1131	4231

<1> Value assumes the carrier frequency is set to 2 kHz.

Appendix: B

Parameter List

This appendix contains a full listing of all parameters and settings available in the drive.

B.1	A: INITIALIZATION PARAMETERS.....	178
B.2	B: APPLICATION.....	179
B.3	C: TUNING.....	185
B.4	D: REFERENCES.....	187
B.5	E: MOTOR PARAMETERS.....	190
B.6	H PARAMETERS: MULTI-FUNCTION TERMINALS.....	196
B.7	L: PROTECTION FUNCTION.....	205
B.8	N: SPECIAL ADJUSTMENT.....	212
B.9	O: OPERATOR-RELATED SETTINGS.....	213
B.10	S: SPECIAL APPLICATION.....	216
B.11	T: MOTOR TUNING.....	221
B.12	U: MONITORS.....	222



B.1 A: Initialization Parameters

Table B.1 Icons Used in Parameter Descriptions

Icon	Description
	Parameter can be changed during run.

The A parameter group creates the operating environment for the drive. This includes the parameter Access Level, Motor Control Method, Password, User Parameters and more.

◆ A1: Initialization

No. (Addr. Hex)	Name	Description	Values	Page
A1-00 (100)  <1>	Language Selection	0: English 1: Japanese 2: German 3: French 4: Italian 5: Spanish 6: Portuguese 7: Chinese	Default: 0 Range: 0 to 7	–
A1-01 (101)  <2>	Access Level Selection	0: View and set A1-01 and A1-04. U□-□□ parameters can also be viewed. 1: User Parameters (access to a set of parameters selected by the user, A2-01 to A2-32) 2: Advanced Access (access to view and set all parameters)	Default: 2 Range: 0 to 2	–
A1-03 (103)	Initialize Parameters	0: No initialization 1110: User Initialize (parameter values must be stored using parameter o2-03) 2220: 2-Wire initialization 3330: 3-Wire initialization 5550: oPE04 error reset 8008 Pump 8009: Pump w/ PI 8010: Fan 8011: Fan w/ PI	Default: 0 Range: 0 to 5550; 8008 to 8011	85
A1-04 (104)	Password	When the value set into A1-04 does not match the value set into A1-05, parameters A1-01 through A1-03 and A2-01 through A2-33 cannot be changed.	Default: 0000 Min.: 0000 Max.: 9999	–
A1-05 (105)	Password Setting	When the value set into A1-04 does not match the value set into A1-05, parameters A1-01 through A1-03 and A2-01 through A2-33 cannot be changed.	Default: 0000 Min.: 0000 Max.: 9999	–
A1-06 (127)	Application Preset	0: General-purpose 8: Pump 9: Pump w/PI 10: Fan 11: Fan w/PI Note: This parameter is not settable. It is used as a monitor only.	Default: 0 Range: 0; 8 to 11	–

<1> Parameter setting value is not reset to the default value when the drive is initialized.

<2> Default setting value is dependent on the Initialization parameter A1-03.

◆ A2: User Parameters

No. (Addr. Hex)	Name	Description	Values	Page
A2-01 to A2-32 (106 to 125)	User Parameters 1 to 32	Recently edited parameters are listed here. The user can also select parameters to appear here for quicker access.	Default: <1> Range: b1-01 to S6-07	–
A2-33 (126)	User Parameter Automatic Selection	0: Parameters A2-01 to A2-32 are reserved for the user to create a list of User Parameters. 1: Save history of recently viewed parameters. Recently edited parameters will be saved to A2-17 through A2-32 for quicker access.	Default: 0 Range: 0, 1	–

<1> Default setting value is dependent on the Initialization parameter A1-03.

B.2 b: Application

Application parameters configure the source of the Run command, DC Injection Braking, Speed Search, timer functions, PID control, the Dwell function, Energy Savings, and a variety of other application-related settings.

◆ b1: Operation Mode Selection

No. (Addr. Hex)	Name	Description	Values	Page
b1-01 (180)	Frequency Reference Selection 1	0: Digital operator 1: Analog input terminals 2: MEMOBUS/Modbus communications 3: Option PCB 4: Pulse input (terminal RP)	Default: 1 Range: 0 to 4	86
b1-02 (181)	Run Command Selection 1	0: Digital operator 1: Digital input terminals 2: MEMOBUS/Modbus communications 3: Option PCB	Default: 1 Range: 0 to 3	87
b1-03 (182)	Stopping Method Selection	0: Ramp to stop 1: Coast to stop 2: DC Injection Braking to stop 3: Coast with timer	Default: 0 Range: 0 to 3	88
b1-04 (183)	Reverse Operation Selection	0: Reverse enabled. 1: Reverse disabled.	Default: 0 Range: 0, 1	–
b1-07 (186)	LOCAL/REMOTE Run Selection	0: An external Run command must be cycled at the new source in order to be activated. 1: An external Run command at the new source is accepted immediately.	Default: 0 Range: 0, 1	–
b1-08 (187)	Run Command Selection in Programming Mode	0: Run command is not accepted while in Programming Mode. 1: Run command is accepted while in Programming Mode. 2: Prohibit entering Programming Mode during run.	Default: 0 Range: 0 to 2	–
b1-11 (1DF)	Run Delay Time Setting Run Delay Time	After a Run command is entered, the drive output waits until this delay time has passed before starting.	Default: 0 s Min.: 0 Max.: 600	–
b1-14 (1C3)	Phase Order Selection	0: Standard 1: Switch phase order (reverses the direction of the motor)	Default: 0 Range: 0, 1	–
b1-15 (1C4)	Frequency Reference Selection 2	Enabled when an input terminal set for “External reference” (H1-□□ = 2) closes. 0: Digital operator 1: Terminals (analog input terminals) 2: MEMOBUS/Modbus communications 3: Option card 4: Pulse train input	Default: 0 Range: 0 to 4	–
b1-16 (1C5)	Run Command Selection 2	Enabled when a terminal set for “External reference” (H1-□□ = 2) closes. 0: Digital operator 1: Digital input terminals 2: MEMOBUS/Modbus communications 3: Option card	Default: 0 Range: 0 to 3	–
b1-17 (1C6)	Run Command at Power Up	0: Disregarded. A new Run command must be issued after power up. 1: Allowed. Motor will start immediately after power up if a Run command is already enabled.	Default: 0 Range: 0, 1	–

◆ b2: DC Injection Braking and Short Circuit Braking

No. (Addr. Hex)	Name	Description	Values	Page
b2-01 (189)	DC Injection Braking Start Frequency	Sets the frequency at which DC Injection Braking starts when “Ramp to stop” (b1-03 = 0) is selected.	Default: 0.5 Hz Min.: 0.0 Max.: 10.0	90
b2-02 (18A)	DC Injection Braking Current	Sets the DC Injection Braking current as a percentage of the drive rated current.	Default: 50% Min.: 0 Max.: 100	–
b2-03 (18B)	DC Injection Braking Time at Start	Sets DC Injection Braking time at start. Disabled when set to 0.00 seconds.	Default: 0.00 s Min.: 0.00 Max.: 10.00	–

B.2 b: Application

No. (Addr. Hex)	Name	Description	Values	Page
b2-04 (18C)	DC Injection Braking Time at Stop	Sets DC Injection Braking time at stop.	Default: 0.50 s Min.: 0.00 Max.: 10.00	–

◆ b3: Speed Search









No. (Addr. Hex.)	Name	Description	Values	Page
b3-01 (191)	Speed Search Selection at Start	0: Disabled 1: Enabled	Default: 0 Range: 0, 1	90
b3-02 (192)	Speed Search Deactivation Current	Sets the current level at which the speed is assumed to be detected and Speed Search is ended. Set as a percentage of the drive rated current.	Default: 120% Min.: 0 Max.: 200	–
b3-03 (193)	Speed Search Deceleration Time	Sets output frequency reduction time during Speed Search.	Default: 2.0 s Min.: 0.1 Max.: 10.0	–
b3-04 (194)	V/f Gain during Speed Search	Determines how much to lower the V/f ratio during Speed Search. Output voltage during Speed Search equals the V/f setting multiplied by b3-04.	Default: <1> Min.: 10% Max.: 100%	–
b3-05 (195)	Speed Search Delay Time	When using an external contactor on the output side, b3-05 delays executing Speed Search after a momentary power loss to allow time for the contactor to close.	Default: 0.2 s Min.: 0.0 Max.: 100.0	–
b3-06 (196)	Output Current 1 during Speed Search	Sets the current injected to the motor at the beginning of Speed Estimation Speed Search. Set as a coefficient for the motor rated current.	Default: <1> Min.: 0.0 Max.: 2.0	–
b3-07 (197)	Output Current 2 during Speed Search (Speed Estimation Type)	Sets the amount of output current during Speed Estimation Speed Search as a coefficient for the no-load current.	Default: <1> Min.: 0.0 Max.: 5.0	–
b3-08 (198)	Current Control Gain during Speed Search (Speed Estimation Type)	Sets the proportional gain for the current controller during Speed Search.	Default: 0.8 Min.: 0.00 Max.: 6.00	–
b3-10 (19A)	Speed Search Detection Compensation Gain	Sets the gain which is applied to the speed detected by Speed Estimation Speed Search before the motor is reaccelerated. Increase this setting if it occurs when performing Speed Search after a relatively long period of baseblock.	Default: 1.05 Min.: 1.00 Max.: 1.20	–
b3-12 (19C)	Minimum Current Detection Level during Speed Search	Sets the minimum current detection level during Speed Search.	Default: 6.0 Min.: 2.0 Max.: 10.0	–
b3-14 (19E)	Bi-Directional Speed Search Selection	0: Disabled (uses the direction of the frequency reference) 1: Enabled (drive detects which way the motor is rotating)	Default: 1 Range: 0, 1	–
b3-17 (1F0)	Speed Search Restart Current Level	Sets the Speed Search restart current level as a percentage of the drive rated current.	Default: 150% Min.: 0 Max.: 200	–
b3-18 (1F1)	Speed Search Restart Detection Time	Sets the time to detect Speed Search restart.	Default: 0.10 s Min.: 0.00 Max.: 1.00	–
b3-19 (1F2)	Number of Speed Search Restarts	Sets the number of times the drive can attempt to restart when performing Speed Search.	Default: 3 Min.: 0 Max.: 10	–
b3-24 (1C0)	Speed Search Method Selection	0: Current Detection 1: Speed Estimation	Default: 0 Range: 0, 1	–
b3-25 (1C8)	Speed Search Wait Time	Sets the time the drive must wait between each Speed Search restart attempt.	Default: 0.5 s Min.: 0.0 Max.: 30.0	–
b3-26 (1C7)	Direction Determining Level	Sets the level that determines the direction of motor rotation.	Default: <1> Min.: 40 Max.: 60000	–
b3-27 (1C9)	Start Speed Search Select	Selects a condition to activate Speed Search Selection at Start (b3-01) or External Speed Search Command 1 or 2 from the multi-function input. 0: Triggered when a Run command is issued (normal). 1: Triggered when an external baseblock is released.	Default: 0 Range: 0, 1	–

<1> Default setting is dependent on parameter o2-04, Drive Model Selection.



◆ b4: Timer Function

No. (Addr. Hex)	Name	Description	Values	Page
b4-01 (1A3)	Timer Function On-Delay Time	Sets the on-delay and off-delay times for a digital timer output (H2-□□=12). The output is triggered by a digital input programmed to H1-□□=18).	Default: 0.0 s Min.: 0.0 Max.: 3000.0	–
b4-02 (1A4)	Timer Function Off-Delay Time		Default: 0.0 s Min.: 0.0 Max.: 3000.0	–

◆ b5: PID Control



No. (Addr. Hex)	Name	Description	Values	Page
b5-01 (1A5)	PID Function Setting	0: Disabled 1: Enabled (PID output becomes output frequency reference, deviation D controlled)	Default: 0 Range: 0, 1	–
b5-02 (1A6) 	Proportional Gain Setting (P)	Sets the proportional gain of the PID controller.	Default: 1.00 Min.: 0.00 Max.: 25.00	–
b5-03 (1A7) 	Integral Time Setting (I)	Sets the integral time for the PID controller.	Default: 1.0 s Min.: 0.0 Max.: 360.0	–
b5-04 (1A8) 	Integral Limit Setting	Sets the maximum output possible from the integrator as a percentage of the maximum output frequency.	Default: 100.0% Min.: 0.0 Max.: 100.0	–
b5-05 (1A9) 	Derivative Time (D)	Sets D control derivative time.	Default: 0.00 s Min.: 0.00 Max.: 10.00	–
b5-06 (1AA) 	PID Output Limit	Sets the maximum output possible from the entire PID controller as a percentage of the maximum output frequency.	Default: 100.0% Min.: 0.0 Max.: 100.0	–
b5-07 (1AB) 	PID Offset Adjustment	Applies an offset to the PID controller output. Set as a percentage of the maximum output frequency.	Default: 0.0% Min.: -100.0 Max.: 100.0	–
b5-08 (1AC) 	PID Primary Delay Time Constant	Sets a low pass filter time constant on the output of the PID controller.	Default: 0.00 s Min.: 0.00 Max.: 10.00	–
b5-09 (1AD)	PID Output Level Selection	0: Normal output (direct acting) 1: Reverse output (reverse acting)	Default: 0 Range: 0, 1	–
b5-10 (1AE) 	PID Output Gain Setting	Sets the gain applied to the PID output.	Default: 1.00 Min.: 0.00 Max.: 25.00	–
b5-11 (1AF)	PID Output Reverse Selection	0: Negative PID output triggers zero limit. 1: Rotation direction reverses with negative PID output. Note: When using setting 1, make sure reverse operation is permitted by b1-04.	Default: 0 Range: 0, 1	–
b5-12 (1B0)	PID Feedback Loss Detection Selection	0: No fault. Digital output only. 1: Fault detection. Alarm output, drive continues operation. 2: Fault detection. Fault output, drive output is shut off. 3: No fault. Digital output only. No fault detection when PID control is disabled. 4: Fault detection. Alarm is triggered and drive continues to run. Fault detection even when PID is disabled. 5: Fault detection. Drive output shuts off. No fault detection when PID control is disabled.	Default: 0 Range: 0 to 5	–
b5-13 (1B1)	PID Feedback Loss Detection Level	Sets the PID feedback loss detection level as a percentage of the maximum output frequency.	Default: 0% Min.: 0 Max.: 100	–

B.2 b: Application

No. (Addr. Hex)	Name	Description	Values	Page
b5-14 (1B2)	PID Feedback Loss Detection Time	Sets a delay time for PID feedback loss.	Default: 1.0 s Min.: 0.0 Max.: 25.5	–
b5-15 (1B3)	PID Sleep Function Start Level	Sets the frequency level that triggers the sleep function.	Default: 0.0 Hz Min.: 0.0 Max.: 400.0	–
b5-16 (1B4)	PID Sleep Delay Time	Sets a delay time before the sleep function is triggered.	Default: 0.0 s Min.: 0.0 Max.: 25.5	–
b5-17 (1B5)	PID Accel/Decel Time	Sets the acceleration and deceleration time to PID setpoint.	Default: 0.0 s Min.: 0.0 Max.: 6000.0	–
b5-18 (1DC)	PID Setpoint Selection	0: Disabled 1: Enabled	Default: 0 Range: 0, 1	–
b5-19 (1DD) 	PID Setpoint Value	Sets the PID target value as a percentage of the maximum output frequency when b5-18 is set to 1. Note: Values set above b5-38 will be internally limited to b5-38	Default: 0.00% Min.: 0.00 Max.: 600.00	–
b5-20 (1E2)	PID Setpoint Scaling PID Disp Scaling	0: 0.01 Hz units 1: 0.01% units (100% = max output frequency) 2: RPM (number of motor poles must entered) 3: User-set (set scaling to b5-38 and b5-39, units based on b5-46 setting)	Default: 1 Range: 0 to 3	–
b5-34 (19F) 	PID Output Lower Limit	Sets the minimum output possible from the PID controller as a percentage of the maximum output frequency.	Default: 0.00% Min.: -100.00 Max.: 100.00	–
b5-35 (1A0) 	PID Input Limit	Limits the PID control input (deviation signal) as a percentage of the maximum output frequency. Acts as a bipolar limit.	Default: 1000.0% Min.: 0.0 Max.: 1000.0	–
b5-36 (1A1)	PID Feedback High Detection Level	Sets the PID feedback high detection level as a percentage of the maximum output frequency.	Default: 100% Min.: 0 Max.: 100	–
b5-37 (1A2)	PID Feedback High Detection Time	Sets the PID feedback high level detection delay time.	Default: 1.0 s Min.: 0.0 Max.: 25.5	–
b5-38 (1FE)	PID Setpoint User Display PID UstrDspMaxVal	Scales the PID units to the maximum output frequency.	Default: 10000 Min.: 1 Max.: 60000	–
b5-39 (1FF)	PID Setpoint Display Digits PID UstrDspDigits	0: No decimal places 1: One decimal place 2: Two decimal places 3: Three decimal places	Default: 2 Range: 0 to 3	–
b5-40 (17F)	Frequency Reference Monitor Content during PID	0: Display the frequency reference (U1-01) after PID compensation has been added. 1: Display the frequency reference (U1-01) before PID compensation has been added.	Default: 0 Range: 0, 1	–
b5-41 (160)	PI Output 2 Unit Selection PI Out2 Unit Sel	0: WC 0: WC (Inch of water) 1: PSI 1: PSI (Pounds per square inch) 2: GPM 2: GPM (Gallons per minute) 3: F 3: °F (Degrees Fahrenheit) 4: CFM 4: CFM (Cubic feet per minute) 5: CMH 5: CMH (Cubic meters per hour) 6: LPH 6: LPH (Liters per hour) 7: LPS 7: LPS (Liters per second) 8: Bar 8: Bar (Bar) 9: Pa 9: Pa (Pascal) 10: C 10: °C (Degrees Celsius) 11: Mtr 11: Mtr (Meters) 12: Ft 12: Ft (Feet) 13: LPM 13: LPM (Liters per minute) 14: CMM 14: CMM (Cubic meters per minute) 15: °Hg 15: °Hg (Inches of Mercury) 25: None 25: None	Default: 0 Range: 0 to 15; 25	–

No. (Addr. Hex)	Name	Description	Values	Page
b5-42 (161) 	PI Output 2 Calculation Mode PI Out2 Calc Mode	0: Linear - the monitor displays PID output 1: Square root - the monitor displays square root PID output 2: Quadratic - the monitor displays 1/(PID output) 3: Cubic - the monitor displays 1/(PID output) Note: Used for U5-14 and U5-15 only.	Default: 0 Range: 0 to 3	-
b5-43 (162) 	PI Output 2 Monitor Max Upper 4 Digits PI Out2 MonMax U	Sets the upper 4 digits of the maximum monitor value. Used with b5-44 to set maximum monitor value of U5-14 and U5-15 at maximum frequency. Note: Used for U5-14 and U5-15 only.	Default: 0 Min.: 0 Max.: 9999	-
b5-44 (163) 	PI Output 2 Monitor Max Lower 4 Digits PI Out2 MonMax L	Sets the lower 4 digits of the maximum monitor value. Used with b5-43 to set maximum monitor value of U5-14 and U5-15 at maximum frequency. Note: Used for U5-14 and U5-15 only.	Default: 0 Min.: 0 Max.: 99.99	-
b5-45 (164) 	PI Output 2 Monitor Minimum PI Out2 MonMin	Sets the minimum display value at zero speed. This function is effective when b5-42 is set to 0 (Linear output mode). Note: Used for U5-14 and U5-15 only.	Default: 0 Min.: 0 Max.: 999.9	-
b5-46 (165)	PID Units Selection PID Unit Sel	Sets the display units for parameter b5-19, and monitors U5-01, U5-04 and U5-99 0: WC ₀ : WC (Inch of water) 1: PSI ₁ : PSI (Pounds per square inch) 2: GPM ₂ : GPM (Gallons per minute) 3: F ₃ : °F (Degrees Fahrenheit) 4: CFM ₄ : CFM (Cubic feet per minute) 5: CMH ₅ : CMH (Cubic meters per hour) 6: LPH ₆ : LPH (Liters per hour) 7: LPS ₇ : LPS (Liters per second) 8: Bar ₈ : Bar (Bar) 9: Pa ₉ : Pa (Pascal) 10: C ₁₀ : °C (Degrees Celsius) 11: Mtr ₁₁ : Mtr (Meters) 12: Ft ₁₂ : Ft (Feet) 13: LPM ₁₃ : LPM (Liters per minute) 14: CMM ₁₄ : CMM (Cubic meters per minute) 15: "Hg ₁₅ : Hg (Inches of Mercury) 25: None ₂₅ : None	Default: 0 Range: 0 to 15; 25	-
b5-47 (17D)	Reverse Operation Selection 2 by PID Output Output Rev Sel2	0: Zero limit when PID output is a negative value. 1: Reverse operation when PID output is a negative value (Zero limit if the reverse operation is prohibited by b1-04).	Default: 1 Range: 0, 1	-
b5-89 (B89) 	Sleep Method Selection Sleep Method Sel	Determines how the drive sleeps and wakes-up when using PID. 0: Standard 1: EZ Sleep/Wake-up	Default: 0 Range: 0, 1	-
b5-90 (B90) <>	EZ Sleep Unit EZ Sleep Unit	Sets the unit, range, and resolution of parameters b5-91 and b5-92. 0: Hz 1: RPM (number of motor poles must be entered)	Default: 0 Range: 0, 1	-
b5-91 (B91) <>	EZ Minimum Speed EZ Min Speed	Sets the PID minimum speed and integral lower limit. The internal value is lower limited to the higher setting between b5-34 and d2-02.	Default: 0.0 Hz Range: 0.0 to 400.0 Hz or 0 to 24000 RPM <>	-
b5-92 (B92) <>	EZ Sleep Level EZ Sleep Level	The drive will go to sleep when the drive output frequency (or speed) is at or below this level for the time set in b5-93. This parameter is internally lower limited to b5-91 (EZ Min Speed) + 1Hz.	Default: 0.0 Hz Range: 0.0 to 400.0 Hz or 0 to 24000 RPM <>	-
b5-93 (B93) <>	EZ Sleep Time EZ Sleep Time	The drive will go to sleep when the drive output frequency is at or below the level set to b5-92 for the time set in this parameter.	Default: 5.0 s Min.: 0.0 Max.: 1000.0	-

B.2 b: Application

No. (Addr. Hex)	Name	Description	Values	Page
b5-94 (B94)  </>	EZ Wake-up Level EZ Wake-up Lvl	When b5-95 is set to 0 (Absolute), the drive wakes-up when the PID Feedback (H3-□□ = 20) drops below this level for the time set in b5-96. For reverse-acting, the PID Feedback must be above this level for the time set in b5-96. When b5-95 is set to 1 (Setpoint Delta), the drive wakes-up when the PID Feedback (H3-□□ = 20) drops below the PID Setpoint minus this level (for normal acting PID) for the time set in b5-96. For reverse-acting, Wake-up level is PID Setpoint plus this level. The PID Feedback must be above the wake-up level for the time set in b5-96.	Default: 0.00% Min.: 0.00 Max.: 600.00	–
b5-95 (B95) </>	EZ Wake-up Mode EZ Wake-up Mode	Sets how the wake-up level is determined. 0: Absolute 1: Setpoint Delta	Default: 0 Range: 0, 1	–
b5-96 (B96)  </>	EZ Wake-up Time EZ Wake-up Time	The drive will wake up when the PID Feedback drops below the b5-94, EZ Wake-up Level for the time set in this parameter.	Default: 1.0 s Min.: 0.0 Max.: 1000.0	–

<1> Unit and resolution are determined by b5-20, b5-39 and b5-46. Internally limited to b5-38. Changing b5-20, b5-38 and b5-39 will not automatically update the value of this parameter.

<2> Parameter is only effective when EZ Sleep is enabled by setting b5-89 to 1.

<3> Unit, range and resolution is determined by b5-90. Changing b5-90 will not automatically update the value of this parameter.

◆ b6: Dwell Function

No. (Addr. Hex)	Name	Description	Values	Page
b6-01 (1B6)	Dwell Reference at Start	Parameters b6-01 and b6-02 set the frequency to hold and the time to maintain that frequency at start.	Default: 0.0 Hz Min.: 0.0 Max.: 400.0	–
b6-02 (1B7)	Dwell Time at Start		Default: 0.0 s Min.: 0.0 Max.: 10.0	–
b6-03 (1B8)	Dwell Reference at Stop	Parameters b6-03 and b6-04 set the frequency to hold and the time to maintain that frequency at stop.	Default: 0.0 Hz Min.: 0.0 Max.: 400.0	–
b6-04 (1B9)	Dwell Time at Stop		Default: 0.0 s Min.: 0.0 Max.: 10.0	–

◆ b8: Energy Saving

No. (Addr. Hex)	Name	Description	Values	Page
b8-01 (1CC)	Energy Saving Control Selection	0: Disabled 1: Enabled	Default: 0 Range: 0, 1	–
b8-04 (1CF)	Energy Saving Coefficient Value	Determines the level of maximum motor efficiency. Setting range is 0.0 to 2000.0 for drives 3.7 kW and smaller. The display resolution depends on the rated output power of the drive.	Default: </> </> Min.: 0.00 Max.: 655.00	–
b8-05 (1D0)	Power Detection Filter Time	Sets a time constant filter for output power detection.	Default: 20 ms Min.: 0 Max.: 2000	–
b8-06 (1D1)	Search Operation Voltage Limit	Sets the limit for the voltage search operation as a percentage of the motor rated voltage.	Default: 0% Min.: 0 Max.: 100	–

<1> Default setting is dependent on parameter o2-04, Drive Model Selection.

<2> Parameter value changes automatically if E2-11 is manually changed or changed by Auto-Tuning.

B.3 C: Tuning

C parameters are used to adjust the acceleration and deceleration times, S-curves, torque compensation, and carrier frequency selections.

◆ C1: Acceleration and Deceleration Times

No. (Addr. Hex)	Name	Description	Values	Page
C1-01 (200) 	Acceleration Time 1	Sets the time to accelerate from 0 to maximum frequency.	Default: 10.0 s Min.: 0.0 Max.: 6000.0 </>	93
C1-02 (201) 	Deceleration Time 1	Sets the time to decelerate from maximum frequency to 0.		93
C1-03 (202) 	Acceleration Time 2	Sets the time to accelerate from 0 to maximum frequency.	Default: 10.0 s Min.: 0.0 Max.: 6000.0 </>	93
C1-04 (203) 	Deceleration Time 2	Sets the time to decelerate from maximum frequency to 0.		93
C1-09 (208) 	Fast Stop Time	Sets the time for the Fast Stop function.	Default: 10.0 s Min.: 0.0 Max.: 6000.0 </>	–
C1-10 (209)	Accel/Decel Time Setting Units	0: 0.01 s (0.00 to 600.00 s) 1: 0.1 s (0.0 to 6000.0 s)	Default: 1 Range: 0, 1	–
C1-11 (20A)	Accel/Decel Time Switching Frequency	Sets the frequency to switch between accel/decel time settings	Default: 0.0 Hz Min.: 0.0 Max.: 400.0	–

</> Setting range value is dependent on parameter C1-10, Accel/Decel Time Setting Units. When C1-10 = 0 (units of 0.01 seconds), the setting range becomes 0.00 to 600.00 seconds.

◆ C2: S-Curve Characteristics

No. (Addr. Hex)	Name	Description	Values	Page
C2-01 (20B)	S-Curve Characteristic at Accel Start	<p>The S-curve can be controlled at the four points shown below.</p>	Default: 0.20 s Min.: 0.00 Max.: 10.00	–
C2-02 (20C)	S-Curve Characteristic at Accel End		Default: 0.20 s Min.: 0.00 Max.: 10.00	–
C2-03 (20D)	S-Curve Characteristic at Decel Start		Default: 0.20 s Min.: 0.00 Max.: 10.00	–
C2-04 (20E)	S-Curve Characteristic at Decel End		Default: 0.00 s Min.: 0.00 Max.: 10.00	–

◆ C3: Slip Compensation

No. (Addr. Hex)	Name	Description	Values	Page
C3-01 (20F) 	Slip Compensation Gain	Sets the gain for the motor slip compensation function used for motor 1.	Default: 0.0 Min.: 0.0 Max.: 2.5	–
C3-02 (210) 	Slip Compensation Primary Delay Time	Adjusts the slip compensation function delay time used for motor 1.	Default: 2000 ms Min.: 0 Max.: 10000	–
C3-03 (211)	Slip Compensation Limit	Sets an upper limit for the slip compensation function as a percentage of motor rated slip for motor 1 (E2-02).	Default: 200% Min.: 0 Max.: 250	–
C3-04 (212)	Slip Compensation Selection during Regeneration	0: Disabled. 1: Enabled above 6 Hz. 2: Enabled whenever slip compensation is possible.	Default: 0 Range: 0 to 2	–

◆ C4: Torque Compensation

No. (Addr. Hex)	Name	Description	Values	Page
C4-01 (215) 	Torque Compensation Gain	Sets the gain for the automatic torque (voltage) boost function and helps to produce better starting torque. Used for motor 1.	Default: 1.00 Min.: 0.00 Max.: 2.50	–
C4-02 (216) 	Torque Compensation Primary Delay Time 1	Sets the torque compensation filter time.	Default: 200 ms Min.: 0 ms Max.: 60000 ms	–

◆ C6: Carrier Frequency











No. (Addr. Hex)	Name	Description	Values	Page
C6-02 (224)	Carrier Frequency Selection	1: 2.0 kHz 2: 5.0 kHz (4.0 kHz) 3: 8.0 kHz (6.0 kHz) 4: 10.0 kHz (8.0 kHz) 5: 12.5 kHz (10.0 kHz) 6: 15.0 kHz (12.0 kHz) 7: Swing PWM1 (Audible sound 1) 8: Swing PWM2 (Audible sound 2) 9: Swing PWM3 (Audible sound 3) A: Swing PWM4 (Audible sound 4) B to E: No setting possible F: User-defined (determined by C6-03 through C6-05)	Default: 7 Range: 1 to 9; A, F	94
C6-03 (225)	Carrier Frequency Upper Limit	<p>Determines the upper and lower limits for the carrier frequency.</p>	Default: <1> Min.: 1.0 kHz Max.: 15.0 kHz	–
C6-04 (226)	Carrier Frequency Lower Limit		Default: <1> Min.: 1.0 kHz Max.: 15.0 kHz	–
C6-05 (227)	Carrier Frequency Proportional Gain		Default: <1> Min.: 0 Max.: 99	–

<1> Default setting value is dependent on parameter C6-02, Carrier Frequency Selection.

B.4 d: References

Reference parameters set the various frequency reference values during operation.

◆ d1: Frequency Reference

No. (Addr. Hex)	Name	Description	Values	Page
d1-01 (280) 	Frequency Reference 1	Sets the frequency reference for the drive. Setting units are determined by parameter o1-03.	Default: 0.00 Hz Min.: 0.00 Max.: 400.00 <I>	94
d1-02 (281) 	Frequency Reference 2	Sets the frequency reference for the drive. Setting units are determined by parameter o1-03.	Default: 0.00 Hz Min.: 0.00 Max.: 400.00 <I>	94
d1-03 (282) 	Frequency Reference 3	Sets the frequency reference for the drive. Setting units are determined by parameter o1-03.	Default: 0.00 Hz Min.: 0.00 Max.: 400.00 <I>	94
d1-04 (283) 	Frequency Reference 4	Sets the frequency reference for the drive. Setting units are determined by parameter o1-03.	Default: 0.00 Hz Min.: 0.00 Max.: 400.00 <I>	94
d1-05 (284) 	Frequency Reference 5	Sets the frequency reference for the drive. Setting units are determined by parameter o1-03.	Default: 0.00 Hz Min.: 0.00 Max.: 400.00 <I>	94
d1-06 (285) 	Frequency Reference 6	Sets the frequency reference for the drive. Setting units are determined by parameter o1-03.	Default: 0.00 Hz Min.: 0.00 Max.: 400.00 <I>	94
d1-07 (286) 	Frequency Reference 7	Sets the frequency reference for the drive. Setting units are determined by parameter o1-03.	Default: 0.00 Hz Min.: 0.00 Max.: 400.00 <I>	94
d1-08 (287) 	Frequency Reference 8	Sets the frequency reference for the drive. Setting units are determined by parameter o1-03.	Default: 0.00 Hz Min.: 0.00 Max.: 400.00 <I>	94
d1-09 (288) 	Frequency Reference 9	Sets the frequency reference for the drive. Setting units are determined by parameter o1-03.	Default: 0.00 Hz Min.: 0.00 Max.: 400.00 <I>	94
d1-10 (28B) 	Frequency Reference 10	Sets the frequency reference for the drive. Setting units are determined by parameter o1-03.	Default: 0.00 Hz Min.: 0.00 Max.: 400.00 <I>	94
d1-11 (28C) 	Frequency Reference 11	Sets the frequency reference for the drive. Setting units are determined by parameter o1-03.	Default: 0.00 Hz Min.: 0.00 Max.: 400.00 <I>	94
d1-12 (28D) 	Frequency Reference 12	Sets the frequency reference for the drive. Setting units are determined by parameter o1-03.	Default: 0.00 Hz Min.: 0.00 Max.: 400.00 <I>	94
d1-13 (28E) 	Frequency Reference 13	Sets the frequency reference for the drive. Setting units are determined by parameter o1-03.	Default: 0.00 Hz Min.: 0.00 Max.: 400.00 <I>	94
d1-14 (28F) 	Frequency Reference 14	Sets the frequency reference for the drive. Setting units are determined by parameter o1-03.	Default: 0.00 Hz Min.: 0.00 Max.: 400.00 <I>	94
d1-15 (290) 	Frequency Reference 15	Sets the frequency reference for the drive. Setting units are determined by parameter o1-03.	Default: 0.00 Hz Min.: 0.00 Max.: 400.00 <I>	94
d1-16 (291) 	Frequency Reference 16	Sets the frequency reference for the drive. Setting units are determined by parameter o1-03.	Default: 0.00 Hz Min.: 0.00 Max.: 400.00 <I>	94

B.4 d: References

No. (Addr. Hex)	Name	Description	Values	Page
d1-17 (292) 	Jog Frequency Reference	Sets the Jog frequency reference. Setting units are determined by parameter o1-03.	Default: 6.00 Hz Min.: 0.00 Max.: 400.00 <1>	94

<1> Range upper limit is determined by parameters d2-01, Frequency Reference Upper Limit, and E1-04, Maximum Output Frequency.



◆ d2: Frequency Upper/Lower Limits





No. (Addr. Hex.)	Name	Description	Setting	Page
d2-01 (289)	Frequency Reference Upper Limit	Sets the frequency reference upper limit as a percentage of the maximum output frequency.	Default: 100.0% Min.: 0.0 Max.: 110.0	–
d2-02 (28A)	Frequency Reference Lower Limit	Sets the frequency reference lower limit as a percentage of the maximum output frequency.	Default: 0.0% Min.: 0.0 Max.: 110.0	–
d2-03 (293)	Master Speed Reference Lower Limit	Sets the lower limit for frequency references from analog inputs as a percentage of the maximum output frequency.	Default: 0.0% Min.: 0.0 Max.: 110.0	–

◆ d3: Jump Frequency

No. (Addr. Hex)	Name	Description	Values	Page
d3-01 (294)	Jump Frequency 1	Eliminates problems with resonant vibration of the motor/machine by avoiding continuous operation in predefined frequency ranges. The drive accelerates and decelerates the motor through the prohibited frequency ranges. Setting 0.0 disables this function. Parameters must be set so that $d3-01 \geq d3-02 \geq d3-03$.	Default: 0.0 Hz Min.: 0.0 Max.: 400.0	–
d3-02 (295)	Jump Frequency 2	Eliminates problems with resonant vibration of the motor/machine by avoiding continuous operation in predefined frequency ranges. The drive accelerates and decelerates the motor through the prohibited frequency ranges. Setting 0.0 disables this function. Parameters must be set so that $d3-01 \geq d3-02 \geq d3-03$.	Default: 0.0 Hz Min.: 0.0 Max.: 400.0	–
d3-03 (296)	Jump Frequency 3	Eliminates problems with resonant vibration of the motor/machine by avoiding continuous operation in predefined frequency ranges. The drive accelerates and decelerates the motor through the prohibited frequency ranges. Setting 0.0 disables this function. Parameters must be set so that $d3-01 \geq d3-02 \geq d3-03$.	Default: 0.0 Hz Min.: 0.0 Max.: 400.0	–
d3-04 (297)	Jump Frequency Width	Sets the dead-band width around each selected prohibited frequency reference point.	Default: 1.0 Hz Min.: 0.0 Max.: 20.0	–

◆ d4: Frequency Reference Hold and Up/Down 2 Function

No. (Addr. Hex)	Name	Description	Values	Page
d4-01 (298)	Frequency Reference Hold Function Selection	0: Disabled. Drive starts from zero when the power is switched on. 1: Enabled. At power up, the drive starts the motor at the Hold frequency that was saved.	Default: 0 Range: 0, 1	–
d4-03 (2AA) 	Frequency Reference Bias Step (Up/Down 2)	Sets the bias added to the frequency reference when the Up 2 and Down 2 digital inputs are enabled (H1-□□ = 75, 76).	Default: 0.00 Hz Min.: 0.00 Max.: 99.99	–
d4-04 (2AB) 	Frequency Reference Bias Accel/Decel (Up/Down 2)	0: Use selected accel/decel time. 1: Use accel/decel time 4 (C1-07 and C1-08). Note: The functionality of setting 1 is only accessible via MEMOBUS/Modbus communication.	Default: 0 Range: 0, 1	–

No. (Addr. Hex)	Name	Description	Values	Page
d4-05 (2AC) 	Frequency Reference Bias Operation Mode Selection (Up/Down 2)	0: Bias value is held if no input Up 2 or Down 2 is active. 1: When the Up 2 reference and Down 2 reference are both on or both off, the applied bias becomes 0. The specified accel/decel times are used for acceleration or deceleration.	Default: 0 Range: 0, 1	–
d4-06 (2AD)	Frequency Reference Bias (Up/Down 2)	The Up/Down 2 bias value is saved in d4-06 when the frequency reference is not input by the digital operator. Set as a percentage of the maximum output frequency.	Default: 0.0% Min.: -99.9 Max.: 100.0	–
d4-07 (2AE) 	Analog Frequency Reference Fluctuation Limit (Up/Down 2)	Limits how much the frequency reference is allowed to change while an input terminal set for Up 2 or Down 2 is enabled. If the frequency reference changes for more than the set value, then the bias value is held and the drive accelerates or decelerates to the frequency reference. Set as a percentage of the maximum output frequency.	Default: 0.01% Min.: 0.01 Max.: 100.0	–
d4-08 (2AF) 	Frequency Reference Bias Upper Limit (Up/Down 2)	Sets the upper limit for the bias and the value that can be saved in d4-06. Set as a percentage of the maximum output frequency.	Default: 1.0% Min.: 0.0 Max.: 100.0	–
d4-09 (2B0) 	Frequency Reference Bias Lower Limit (Up/Down 2)	Sets the lower limit for the bias and the value that can be saved in d4-06. Set as a percentage of the maximum output frequency.	Default: 0.0% Min.: -99.9 Max.: 0.0	–
d4-10 (2B6)	Up/Down Frequency Reference Limit Selection	0: The lower limit is determined by d2-02 or an analog input. 1: The lower limit is determined by d2-02.	Default: 0 Range: 0, 1	–

◆ d6: Field Weakening and Field Forcing

No. (Addr. Hex.)	Name	Description	Values	Page
d6-01 (2A0)	Field Weakening Level	Sets the drive output voltage for the Field Weakening function as a percentage of the maximum output voltage. Enabled when a multi-function input is set for Field Weakening (H1-□□ = 63).	Default: 80% Min.: 0 Max.: 100	–
d6-02 (2A1)	Field Weakening Frequency Limit	Sets the lower limit of the frequency range where Field Weakening control is valid. The Field Weakening command is valid only at frequencies above this setting and only when the output frequency matches the frequency reference (speed agree).	Default: 0.0 Hz Min.: 0.0 Max.: 400.0	–

B.5 E: Motor Parameters

◆ E1: V/f Pattern

No. (Addr. Hex)	Name	Description	Values	Page
E1-01 (300)	Input Voltage Setting	This parameter must be set to the power supply voltage. WARNING! Electrical Shock Hazard. Drive input voltage (not motor voltage) must be set in E1-01 for the protective features of the drive to function properly. Failure to do so may result in equipment damage and/or death or personal injury.	Default: 230 V <1> Min.: 155 Max.: 255 <1>	96
E1-03 (302)	V/f Pattern Selection	0: 50 Hz, Constant torque 1 1: 60 Hz, Constant torque 2 2: 60 Hz, Constant torque 3 (50 Hz base) 3: 72 Hz, Constant torque 4 (60 Hz base) 4: 50 Hz, Variable torque 1 5: 50 Hz, Variable torque 2 6: 60 Hz, Variable torque 3 7: 60 Hz, Variable torque 4 8: 50 Hz, High starting torque 1 9: 50 Hz, High starting torque 2 A: 60 Hz, High starting torque 3 B: 60 Hz, High starting torque 4 C: 90 Hz (60 Hz base) D: 120 Hz (60 Hz base) E: 180 Hz (60 Hz base) F: Custom V/f, E1-04 through E1-13 settings define the V/f pattern	Default: F <2> Range: 0 to 9; A to FF	97
E1-04 (303)	Maximum Output Frequency	<p>These parameters are only applicable when E1-03 is set to F. To set linear V/f characteristics, set the same values for E1-07 and E1-09. In this case, the setting for E1-08 will be disregarded. Ensure that the four frequencies are set according to these rules: $E1-09 \leq E1-07 < E1-06 \leq E1-11 \leq E1-04$</p>	Default: 60.0 Hz Min.: 40.0 Max.: 400.0	100
E1-05 (304)	Maximum Voltage		Default: 575 V <1> Min.: 0.0 Max.: 255.0	100
E1-06 (305)	Base Frequency		Default: 60.0 Hz Min.: 0.0 Max.: E1-04	100
E1-07 (306)	Middle Output Frequency		Default: 3.0 Hz Min.: 0.0 Max.: E1-04	100
E1-08 (307)	Middle Output Frequency Voltage		Default: 15.0 V <1> Min.: 0.0 V Max.: 255.0 V	100
E1-09 (308)	Minimum Output Frequency		Default: 1.5 Hz Min.: 0.0 Max.: E1-04	100
E1-10 (309)	Minimum Output Frequency Voltage		Default: 9.0 V <1> Min.: 0.0 V Max.: 255.0 V	100
E1-11 (30A) <4>	Middle Output Frequency 2		Default: 0.0 Hz Min.: 0.0 Max.: E1-04	100
E1-12 (30B) <4>	Middle Output Frequency Voltage 2		Default: 0.0 V Min.: 0.0 Max.: 255.0 V <1>	100
E1-13 (30C)	Base Voltage		Default: 0.0 V <3> Min.: 0.0 Max.: 255.0 V <1>	100

<1> Values shown are specific to 200 V class drives. Double the value for 400 V class drives. Multiply the value by 2.875 for 600 V class drives.

<2> Parameter setting value is not reset to the default value when the drive is initialized.

<3> When Auto-Tuning is performed, E1-13 and E1-05 will be set to the same value.

<4> Parameter ignored when E1-11 (Motor 1 Mid Output Frequency 2) and E1-12 (Motor 1 Mid Output Frequency Voltage 2) are set to 0.0.





◆ E2: Motor 1 Parameters

No. (Addr. Hex)	Name	Description	Values	Page
E2-01 (30E)	Motor Rated Current	Sets the motor nameplate full load current in amps. Automatically set during Auto-Tuning.	Default: <1> Min.: 10% of drive rated current Max.: 200% of drive rated current <2>	100
E2-02 (30F)	Motor Rated Slip	Sets the motor rated slip. Automatically set during Auto-Tuning.	Default: <1> Min.: 0.00 Hz Max.: 20.00 Hz	–
E2-03 (310)	Motor No-Load Current	Sets the no-load current for the motor. Automatically set during Auto-Tuning.	Default: <1> Min.: 0 A Max.: E2-01 <2>	–
E2-04 (311)	Number of Motor Poles	Sets the number of motor poles. Automatically set during Auto-Tuning.	Default: 4 Min.: 2 Max.: 48	–
E2-05 (312)	Motor Line-to-Line Resistance	Sets the phase-to-phase motor resistance. Automatically set during Auto-Tuning.	Default: <1> Min.: 0.000 Ω Max.: 65.000 Ω	–
E2-06 (313)	Motor Leakage Inductance	Sets the voltage drop due to motor leakage inductance as a percentage of motor rated voltage. Automatically set during Auto-Tuning.	Default: <1> Min.: 0.0% Max.: 40.0%	–
E2-10 (317)	Motor Iron Loss for Torque Compensation	Sets the motor iron loss.	Default: <1> Min.: 0 W Max.: 65535 W	–
E2-11 (318)	Motor Rated Power	Sets the motor rated power in kilowatts (1 HP = 0.746 kW). Automatically set during Auto-Tuning.	Default: <1> Min.: 0.00 kW Max.: 650.00 kW	–

<1> Default setting is dependent on parameter o2-04, Drive Model Selection.

<2> The number of decimal places in the parameter value depends on the drive model 1. This value has two decimal places (0.01 A) if the drive is set for a maximum applicable motor capacity up to and including 11 kW, and one decimal place (0.1 A) if the maximum applicable motor capacity is higher than 11 kW.

◆ F4: Analog Monitor Card (AO-A3)

No. (Addr. Hex)	Name	Description	Values	Page
F4-01 (391)	Terminal V1 Monitor Selection	Sets the monitor signal for output from terminal V1. Set this parameter to the last three digits of the desired U□-□□ monitor. Some U parameters are available only in certain control modes.	Default: 102 Range: 000 to 999	–
F4-02 (392) 	Terminal V1 Monitor Gain	Sets the gain for voltage output via terminal V1.	Default: 100.0% Min.: -999.9 Max.: 999.9	–
F4-03 (393)	Terminal V2 Monitor Selection	Sets the monitor signal for output from terminal V2. Set this parameter to the last three digits of the desired U□-□□ monitor. Some U parameters are available only in certain control modes.	Default: 103 Range: 000 to 999	–
F4-04 (394) 	Terminal V2 Monitor Gain	Sets the gain for voltage output via terminal V2.	Default: 50.0% Min.: -999.9 Max.: 999.9	–
F4-05 (395) 	Terminal V1 Monitor Bias	Sets the amount of bias added to the voltage output via terminal V1.	Default: 0.0% Min.: -999.9 Max.: 999.9	–
F4-06 (396) 	Terminal V2 Monitor Bias	Sets the amount of bias added to the voltage output via terminal V2.	Default: 0.0% Min.: -999.9 Max.: 999.9	–
F4-07 (397)	Terminal V1 Signal Level	0: 0 to 10 V 1: -10 to 10 V	Default: 0 Range: 0, 1	–

B.5 E: Motor Parameters

No. (Addr. Hex)	Name	Description	Values	Page
F4-08 (398)	Terminal V2 Signal Level	0: 0 to 10 V 1: -10 to 10 V	Default: 0 Range: 0, 1	—

◆ F6, F7: Communication Option Card

Parameters F6-01 through F6-03 and F6-06 through F6-08 are used for CC-Link, CANopen, DeviceNet, PROFIBUS-DP, and MECHATROLINK-II options. Other parameters in the F6 group are used for communication-protocol-specific settings. F7 parameters are used for EtherNet/IP, Modbus TCP/IP, and PROFINET options.

No. (Addr. Hex)	Name	Description	Values	Page
F6-01 (3A2)	Communications Error Operation Selection	0: Ramp to stop. Decelerate to stop using the deceleration time in C1-02. 1: Coast to stop. 2: Fast Stop. Decelerate to stop using the deceleration time in C1-09. 3: Alarm only.	Default: 1 Range: 0 to 3	—
F6-02 (3A3)	External Fault from Comm. Option Detection Selection	0: Always detected. 1: Detection during run only.	Default: 0 Range: 0, 1	—
F6-03 (3A4)	External Fault from Comm. Option Operation Selection	0: Ramp to stop. Decelerate to stop using the deceleration time in C1-02. 1: Coast to stop. 2: Fast Stop. Decelerate to stop using the deceleration time in C1-09. 3: Alarm only.	Default: 1 Range: 0 to 3	—
F6-04 (3A5)	bUS Error Detection Time	Sets the delay time for error detection if a bus error occurs.	Default: 2.0 s Min.: 0.0 Max.: 5.0	—
F6-07 (3A8)	Multi-Step Speed Enable/Disable Selection when NefRef/ComRef is Selected	0: Multi-step reference disabled (same as F7) 1: Multi-step reference enabled (same as V7)	Default: 0 Range: 0, 1	—
F6-08 (36A) </>	Reset Communication Parameters	0: Communication-related parameters (F6-□□) are not reset when the drive is initialized using A1-03. 1: Reset all communication-related parameters (F6-□□) when the drive is initialized using A1-03.	Default: 0 Range: 0, 1	—
F6-10 (3B6)	CC-Link Node Address	Sets the node address if a CC-Link option is installed.	Default: 0 Min.: 0 Max.: 64	—
F6-11 (3B7)	CC-Link Communication Speed	0: 156 Kbps 1: 625 Kbps 2: 2.5 Mbps 3: 5 Mbps 4: 10 Mbps	Default: 0 Range: 0 to 4	—
F6-14 (3BB)	CC-Link bUS Error Auto Reset	0: Disabled 1: Enabled	Default: 0 Range: 0, 1	—
F6-20 (36B)	MECHATROLINK Station Address	Sets the station address when the MECHATROLINK-II option has been installed.	Default: 21 Min.: 20 Max.: 3F	—
F6-21 (36C)	MECHATROLINK Frame Size	0: 32 byte 1: 17 byte	Default: 0 Range: 0, 1	—
F6-22 (36D)	MECHATROLINK Link Speed	0: 10 Mbps 1: 4 Mbps	Default: 0 Range: 0, 1	—
F6-23 (36E)	MECHATROLINK Monitor Selection (E)	Sets the MECHATROLINK-II monitor (E).	Default: 0 Min.: 0 Max.: FFFF	—
F6-24 (36F)	MECHATROLINK Monitor Selection (F)	Sets the MECHATROLINK-II monitor (F).	Default: 0 Min.: 0 Max.: FFFF	—
F6-25 (3C9)	Operation Selection at Watchdog Timer Error (E5)	0: Ramp to stop. Decelerate using the deceleration time in C1-02. 1: Coast to stop 2: Fast stop. Decelerate using the deceleration time in C1-09. 3: Alarm only	Default: 1 Range: 0 to 3	—
F6-26 (3CA)	MECHATROLINK bUS Errors Detected	Sets the number of option communication errors (bUS).	Default: 2 Min.: 2 Max.: 10	—

No. (Addr. Hex)	Name	Description	Values	Page
F6-30 (3CB)	PROFIBUS-DP Node Address	Sets the node address.	Default: 0 Min.: 0 Max.: 125	–
F6-31 (3CC)	PROFIBUS-DP Clear Mode Selection	0: Resets drive operation with a Clear mode command. 1: Maintains the previous operation state when Clear mode command is given.	Default: 0 Range: 0, 1	–
F6-32 (3CD)	PROFIBUS-DP Data Format Selection	0: PPO Type 1: Conventional	Default: 0 Range: 0, 1	–
F6-35 (3D0)	CANopen Node ID Selection	Sets the node address.	Default: 0 Min.: 0 Max.: 126	–
F6-36 (3D1)	CANopen Communication Speed	0: Auto-detection 1: 10 kbps 2: 20 kbps 3: 50 kbps 4: 125 kbps 5: 250 kbps 6: 500 kbps 7: 800 kbps 8: 1 Mbps	Default: 6 Range: 0 to 8	–
F6-50 (3C1)	DeviceNet MAC Address	Selects the drive MAC address.	Default: 64 Min.: 0 Max.: 64	–
F6-51 (3C2)	DeviceNet Communication Speed	0: 125 kbps 1: 250 kbps 2: 500 kbps 3: Adjustable from network 4: Detect automatically	Default: 4 Range: 0 to 4	–
F6-52 (3C3)	DeviceNet PCA Setting	Sets the format of the data set from the DeviceNet master to the drive.	Default: 21 Min.: 0 Max.: 255	–
F6-53 (3C4)	DeviceNet PPA Setting	Sets the format of the data set from the drive to the DeviceNet master.	Default: 71 Min.: 0 Max.: 255	–
F6-54 (3C5)	DeviceNet Idle Mode Fault Detection	0: Enabled 1: Disabled, no fault detection	Default: 0 Range: 0, 1	–
F6-55 (3C6)	DeviceNet Baud Rate Monitor	Verifies the baud rate running on the network. 0: 125 kbps 1: 250 kbps 2: 500 kbps	Default: 0 Range: 0 to 2	–
F6-56 (3D7)	DeviceNet Speed Scaling	Sets the scaling factor for the speed monitor in DeviceNet.	Default: 0 Min.: -15 Max.: 15	–
F6-57 (3D8)	DeviceNet Current Scaling	Sets the scaling factor for the output current monitor in DeviceNet.	Default: 0 Min.: -15 Max.: 15	–
F6-58 (3D9)	DeviceNet Torque Scaling	Sets the scaling factor for the torque monitor in DeviceNet.	Default: 0 Min.: -15 Max.: 15	–
F6-59 (3DA)	DeviceNet Power Scaling	Sets the scaling factor for the power monitor in DeviceNet.	Default: 0 Min.: -15 Max.: 15	–
F6-60 (3DB)	DeviceNet Voltage Scaling	Sets the scaling factor for the voltage monitor in DeviceNet.	Default: 0 Min.: -15 Max.: 15	–
F6-61 (3DC)	DeviceNet Time Scaling	Sets the scaling factor for the time monitor in DeviceNet.	Default: 0 Min.: -15 Max.: 15	–
F6-62 (3DD)	DeviceNet Heartbeat Interval	Sets the heartbeat interval for DeviceNet communications.	Default: 0 Min.: 0 Max.: 10	–
F6-63 (3DE)	DeviceNet Network MAC ID	Saves and monitors settings 0 to 63 of F6-50 (DeviceNet MAC Address).	Default: 63 Min.: 0 Max.: 63	–

B.5 E: Motor Parameters

No. (Addr. Hex)	Name	Description	Values	Page
F6-64 to F6-71 (3DF to 3C8)	Reserved	Reserved for Dynamic I/O Assembly Parameters.	–	–
F7-01 (3E5) 	IP Address 1	Sets the most significant octet of network static IP address.	Default: 192 Range: 0 to 255	–
F7-02 (3E6) 	IP Address 2	Sets the second most significant octet of network static IP address.	Default: 168 Range: 0 to 255	–
F7-03 (3E7) 	IP Address 3	Sets the third most significant octet of network static IP address.	Default: 1 Range: 0 to 255	–
F7-04 (3E8) 	IP Address 4	Sets the fourth most significant octet of network static IP address.	Default: 20 Range: 0 to 255	–
F7-05 (3E9)	Subnet Mask 1	Sets the most significant octet of network static Subnet Mask.	Default: 255 Range: 0 to 255	–
F7-06 (3EA)	Subnet Mask 2	Sets the second most significant octet of network static Subnet Mask.	Default: 255 Range: 0 to 255	–
F7-07 (3EB)	Subnet Mask 3	Sets the third most significant octet of network static Subnet Mask.	Default: 255 Range: 0 to 255	–
F7-08 (3EC)	Subnet Mask 4	Sets the fourth most significant octet of network static Subnet Mask.	Default: 0 Range: 0 to 255	–
F7-09 (3ED)	Gateway Address 1	Sets the most significant octet of network Gateway address.	Default: 192 Range: 0 to 255	–
F7-10 (3EE)	Gateway Address 2	Sets the second most significant octet of network Gateway address.	Default: 168 Range: 0 to 255	–
F7-11 (3EF)	Gateway Address 3	Sets the third most significant octet of network Gateway address.	Default: 1 Range: 0 to 255	–
F7-12 (3E0)	Gateway Address 4	Sets the fourth most significant octet of network Gateway address.	Default: 1 Range: 0 to 255	–
F7-13 (3F1)	Address Mode at Startup	Select the option address setting method 0: Static  1: BOOTP 2: DHCP	Default: 2 Range: 0 to 2	–
F7-14 (3F2)	Duplex Mode Selection	Selects duplex mode setting. 0: Half duplex forced 1: Auto-negotiate duplex mode and communication speed 2: Full duplex forced	Default: 1 Range: 0 to 2	–
F7-15 (3F3)	Communication Speed Selection	Sets the communication speed 10: 10 Mbps 100: 100 Mbps	Default: 10 Range: 10, 100	–
F7-16 (3F4)	Communication Loss Timeout	Sets the timeout value for communication loss detection in tenths of a second. A value of 0 disables the connection timeout. Example: An entered value of 100 represents 10.0 seconds.	Default: 0 Min.: 0 Max.: 300	–
F7-17 (3F5)	EtherNet/IP Speed Scaling Factor	Sets the scaling factor for the speed monitor in EtherNet/IP Class ID 2AH Object.	Default: 0 Min.: -15 Max.: 15	–
F7-18 (3F6)	EtherNet/IP Current Scaling Factor	Sets the scaling factor for the output current monitor in EtherNet/IP Class ID 2AH Object.	Default: 0 Min.: -15 Max.: 15	–
F7-19 (3F7)	EtherNet/IP Torque Scaling Factor	Sets the scaling factor for the torque monitor in EtherNet/IP Class ID 2AH Object.	Default: 0 Min.: -15 Max.: 15	–
F7-20 (3F8)	EtherNet/IP Power Scaling Factor	Sets the scaling factor for the power monitor in EtherNet/IP Class ID 2AH Object.	Default: 0 Min.: -15 Max.: 15	–
F7-21 (3F9)	EtherNet/IP Voltage Scaling Factor	Sets the scaling factor for the voltage monitor in EtherNet/IP Class ID 2AH Object.	Default: 0 Min.: -15 Max.: 15	–

No. (Addr. Hex)	Name	Description	Values	Page
F7-22 (3FA)	EtherNet/IP Time Scaling	Sets the scaling factor for the time monitor in EtherNet/IP Class ID 2AH Object.	Default: 0 Min.: -15 Max.: 15	-
F7-23 to F7-32 (3FB to 374)	Dynamic Output Assembly Parameters	Parameters used in Output Assembly 116. Each parameter contains a MEMOBUS/Modbus address. The value received for Output Assembly 116 will be written to this corresponding MEMOBUS/Modbus address. A MEMOBUS/Modbus address value of 0 means that the value received for Output Assembly 116 will not be written to any MEMOBUS/Modbus register.	Default: 0	-
F7-33 to F7-42 (375 to 37E)	Dynamic Input Assembly Parameters	Parameters used in Input Assembly 166. Each parameter contains a MEMOBUS/Modbus address. The value sent for Input Assembly 166 will be read from this corresponding MEMOBUS/Modbus address. A MEMOBUS/Modbus address value of 0 means that the value sent for Input Assembly 166 is not defined by the user, therefore the option default register value will be returned.	Default: 0	-

- <1> Parameter setting value is not reset to the default value when the drive is initialized.
- <2> Cycle power for setting changes to take effect.
- <3> If F7-13 is set to 0, all IP addresses (F7-01 to F7-04) must be unique.

B.6 H Parameters: Multi-Function Terminals

H parameters assign functions to the multi-function input and output terminals.

◆ H1: Multi-Function Digital Inputs

No. (Addr. Hex)	Name	Description	Values	Page
H1-01 (438)	Multi-Function Digital Input Terminal S1 Function Selection	Assigns a function to the multi-function digital inputs. Refer to pages 196 to 199 for descriptions of setting values. Note: Set unused terminals to F.	Default: 40 (F) <1> Min.: 1 Max.: 9F	101
H1-02 (439)	Multi-Function Digital Input Terminal S2 Function Selection	Assigns a function to the multi-function digital inputs. Refer to pages 196 to 199 for descriptions of setting values. Note: Set unused terminals to F.	Default: 41 (F) <1> Min.: 1 Max.: 9F	101
H1-03 (400)	Multi-Function Digital Input Terminal S3 Function Selection	Assigns a function to the multi-function digital inputs. Refer to pages 196 to 199 for descriptions of setting values. Note: Set unused terminals to F.	Default: 24 Min.: 0 Max.: 9F	101
H1-04 (401)	Multi-Function Digital Input Terminal S4 Function Selection	Assigns a function to the multi-function digital inputs. Refer to pages 196 to 199 for descriptions of setting values. Note: Set unused terminals to F.	Default: 14 Min.: 0 Max.: 9F	101
H1-05 (402)	Multi-Function Digital Input Terminal S5 Function Selection	Assigns a function to the multi-function digital inputs. Refer to pages 196 to 199 for descriptions of setting values. Note: Set unused terminals to F.	Default: 3 (0) <1> Min.: 0 Max.: 9F	101
H1-06 (403)	Multi-Function Digital Input Terminal S6 Function Selection	Assigns a function to the multi-function digital inputs. Refer to pages 196 to 199 for descriptions of setting values. Note: Set unused terminals to F.	Default: 4 (3) <1> Min.: 0 Max.: 9F	101
H1-07 (404)	Multi-Function Digital Input Terminal S7 Function Selection	Assigns a function to the multi-function digital inputs. Refer to pages 196 to 199 for descriptions of setting values. Note: Set unused terminals to F.	Default: 6 (4) <1> Min.: 0 Max.: 9F	101
H1-08 (405)	Multi-Function Digital Input Terminal S8 Function Selection	Assigns a function to the multi-function digital inputs. Refer to pages 196 to 199 for descriptions of setting values. Note: Set unused terminals to F.	Default: 8 (6) <1> Min.: 0 Max.: 9F	101

<1> Value in parenthesis is the default setting when a 3-Wire initialization is performed (A1-03 = 3330).

H1 Multi-Function Digital Input Selections			
H1-□□ Setting	Function	Description	Page
0	3-Wire sequence	Closed: Reverse rotation (only if the drive is set up for 3-Wire sequence) Terminals S1 and S2 are automatically set up for the Run command and Stop command.	102
1	LOCAL/REMOTE selection	Open: REMOTE (parameter settings determine the source of the frequency Reference 1 or 2 (b1-01, b1-02 or b1-15, b1-16) Closed: LOCAL, Frequency reference and Run command are input from the digital operator.	–
2	External reference 1/2 selection	Open: Run command and frequency reference source 1 (determined by b1-01 and b1-02) Closed: Run command and frequency reference source 2 (determined by b1-15 and b1-16)	–
3	Multi-Step Speed Reference 1	When input terminals are set to Multi-Step Speed References 1 through 3, switching combinations of those terminals will create a multi-step speed sequence using the frequency references set in d1-01 through d1-08.	–
4	Multi-Step Speed Reference 2	When input terminals are set to Multi-Step Speed References 1 through 3, switching combinations of those terminals will create a multi-step speed sequence using the frequency references set in d1-01 through d1-08.	–
5	Multi-Step Speed Reference 3	When input terminals are set to Multi-Step Speed References 1 through 3, switching combinations of those terminals will create a multi-step speed sequence using the frequency references set in d1-01 through d1-08.	–
6	Jog reference selection	Closed: Jog frequency reference (d1-17) selected. Jog has priority over all other reference sources.	–
7	Accel/decel time selection 1	Used to switch between accel/decel time 1 (set in C1-01, C1-02) and accel/decel time 2 (set in C1-03, C1-04).	–
8	Baseblock command (N.O.)	Closed: No drive output	–

H1 Multi-Function Digital Input Selections			
H1-□□ Setting	Function	Description	Page
9	Baseblock command (N.C.)	Open: No drive output	–
A	Accel/decel ramp hold	Open: Accel/decel is not held Closed: The drive pauses during acceleration or deceleration and maintains the output frequency.	–
B	Drive overheat alarm (oH2)	Closed: Closes when an oH2 alarm occurs	–
C	Analog terminal input selection	Open: Function assigned by H3-14 is disabled. Closed: Function assigned by H3-14 is enabled.	–
F	Through mode	Select this setting when using the terminal in a pass-through mode. The terminal does not trigger a drive function but can be used as digital input for the controller the drive is connected to.	–
10	Up command	The drive accelerates when the Up command terminal closes, and decelerates when the Down command closes. When both terminals are closed or both are open, the drive holds the frequency reference. The Up and Down commands must always be used in conjunction with one another.	–
11	Down command	The drive accelerates when the Up command terminal closes, and decelerates when the Down command closes. When both terminals are closed or both are open, the drive holds the frequency reference. The Up and Down commands must always be used in conjunction with one another.	–
12	Forward Jog	Closed: Runs forward at the Jog frequency d1-17.	–
13	Reverse Jog	Closed: Runs reverse at the Jog frequency d1-17.	–
14	Fault reset	Closed: Resets faults if the cause is cleared and the Run command is removed.	–
15	Fast Stop (N.O.)	Closed: Decelerates at the Fast Stop time set to C1-09.	–
17	Fast Stop (N.C.)	Open: Decelerates to stop at the Fast Stop time set to C1-09.	–
18	Timer function input	Triggers the timer set up by parameters b4-01 and b4-02. Must be set in conjunction with the timer function output (H2-□□ = 12).	–
19	PID disable	Open: PID control enabled Closed: PID control disabled	–
1A	Accel/decel time selection 2	Used in conjunction with an input terminal set for “Accel/decel time selection 1” (H1-□□ = 7), and allows the drive to switch between accel/decel times 3 and 4.	–
1B	Program lockout	Open: Parameters cannot be edited (except for U1-01 if the reference source is assigned to the digital operator). Closed: Parameters can be edited and saved.	–
1E	Reference sample hold	Closed: Samples the analog frequency reference and operates the drive at that speed.	–
20 to 2F	External fault	20: N.O., Always detected, ramp to stop 21: N.C., Always detected, ramp to stop 22: N.O., During run, ramp to stop 23: N.C., During run, ramp to stop 24: N.O., Always detected, coast to stop 25: N.C., Always detected, coast to stop 26: N.O., During run, coast to stop 27: N.C., During run, coast to stop 28: N.O., Always detected, Fast Stop 29: N.C., Always detected, Fast Stop 2A: N.O., During run, Fast Stop 2B: N.C., During run, Fast Stop 2C: N.O., Always detected, alarm only (continue running) 2D: N.C., Always detected, alarm only (continue running) 2E: N.O., During run, alarm only (continue running) 2F: N.C., During run, alarm only (continue running)	–
30	PID integral reset	Closed: Resets the PID control integral value.	–
31	PID integral hold	Open: Performs integral operation. Closed: Maintains the current PID control integral value.	–
32	Multi-Step Speed Reference 4	Used in combination with input terminals set to Multi-Step Speed Reference 1, 2, and 3. Use parameters d1-09 to d1-16 to set reference values.	–
34	PID soft starter cancel	Open: PID soft starter is enabled. Closed: Disables the PID soft starter b5-17.	–
35	PID input level selection	Closed: Inverts the PID input signal.	–
40	Forward run command (2-Wire sequence)	Open: Stop Closed: Forward run Note: Cannot be set together with settings 42 or 43.	–

B.6 H Parameters: Multi-Function Terminals

H1 Multi-Function Digital Input Selections			
H1-□□ Setting	Function	Description	Page
41	Reverse run command (2-Wire sequence)	Open: Stop Closed: Reverse run Note: Cannot be set together with settings 42 or 43.	–
42	Run command (2-Wire sequence 2)	Open: Stop Closed: Run Note: Cannot be set together with settings 40 or 41.	–
43	FWD/REV command (2-Wire sequence 2)	Open: Forward Closed: Reverse Note: Determines motor direction, but does not issue a Run command. Cannot be set together with settings 40 or 41.	–
47	Node setup	Closed: Node setup for SI-S3 enabled.	–
51	Sequence Timer Disable SeqTimer Disable	Closed: Drive ignores sequence timers and runs normally (based on b1-02/b1-16 source).	–
52	Sequence Timer Cancel SeqTimer Cancel	Closed: When the input changes from open to closed, the currently active sequence timer is disabled. Operation will resume with the next scheduled sequence timer. Cycling the Run command after the current sequence timer has been canceled will re-enable the sequence timer.	–
60	DC Injection Braking command	Closed: Triggers DC Injection Braking.	–
61	External Speed Search command 1	Closed: Activates Current Detection Speed Search from the maximum output frequency (E1-04).	–
62	External Speed Search command 2	Closed: Activates Current Detection Speed Search from the frequency reference.	–
63	Field weakening	Closed: The drive performs Field Weakening control as set for d6-01 and d6-02.	–
65	KEB Ride-Thru 1 (N.C.)	Open: KEB Ride-Thru 1 enabled.	–
66	KEB Ride-Thru 1 (N.O.)	Closed: KEB Ride-Thru 1 enabled.	–
67	Communications test mode	Tests the MEMOBUS/Modbus RS-422/RS-485 interface. Displays “PASS” if the test completes successfully.	–
68	High Slip Braking (HSB)	Closed: Activates High Slip Braking to stop the drive during a Run command.	–
6A	Drive enable	Open: Drive disabled. If this input is opened during run, the drive will stop as specified by b1-03. Closed: Ready for operation.	–
75	Up 2 command	Used to control the bias added to the frequency reference by the Up/Down 2 function. The Up 2 and Down 2 commands must always be used in conjunction with one another.	–
76	Down 2 command	Used to control the bias added to the frequency reference by the Up/Down 2 function. The Up 2 and Down 2 commands must always be used in conjunction with one another.	–
7A	KEB Ride-Thru 2 (N.C.)	Open: KEB Ride-Thru 2 enabled. Drive disregards L2-29 and performs Single Drive KEB Ride-Thru 2.	–
7B	KEB Ride-Thru 2 (N.O.)	Closed: KEB Ride-Thru 2 enabled. Drive disregards L2-29 and performs Single Drive KEB Ride-Thru 2.	–
A8	Secondary PI Disable (N.O.) PI2 Disable N.O.	Closed: Disables the secondary PI controller. Output behavior depends on the setting of S3-12.	–
A9	Secondary PI Disable (N.C.) PI2 Disable N.C.	Closed: Enables the secondary PI controller. Output behavior depends on the setting of S3-12 when open.	–
AA	Secondary PI Inverse Operation PI2 Invert	Closed: Changes the sign of the secondary PI controller input (reverse acting PI control).	–
AB	Secondary PI Integral Reset PI2 Intrgl Reset	Closed: Resets the secondary PI controller integral value.	–
AC	Secondary PI Integral Hold PI2 Intrgl Hold	Closed: Locks the value of the secondary PI controller integral value.	–
AD	Select Secondary PI Parameters Select PI2 Parm	Closed: Uses the secondary PI controller Proportional and Integral adjustments (S3-06 and S3-07) instead of the primary PI controller Proportional and Integral adjustments (b5-02 and b5-03). Only valid when S3-01 = 0 (secondary PI controller disabled). Note: This multi-function input has no effect on the secondary PI controller. It is only used for the primary PI controller (b5-□□).	–
AF	Emergency Override Forward Run EmergOverrideFWD	Closed: Run the drive forward using the speed set in S6-02.	–

H1 Multi-Function Digital Input Selections			
H1-□□ Setting	Function	Description	Page
B0	Emergency Override Reverse Run EmergOverrideREV	Closed: Run the drive in reverse using the speed set in S6-02.	–

◆ H2: Multi-Function Digital Outputs







No. (Addr. Hex)	Name	Description	Values	Page
H2-01 (40B)	Terminal M1-M2 function selection (relay)	Refer to H2 Multi-Function Digital Output Settings on pages 199 to 200 for descriptions of setting values.	Default: 0 Range: 0 to 192	102
H2-02 (40C)	Terminal M3-M4 function selection (relay)		Default: 1 Range: 0 to 192	102
H2-03 (40D)	Terminal MD-ME-MF Function Selection		Default: 2 Range: 0 to 192	102
H2-06 (437)	Watt Hour Output Unit Selection	Outputs a 200 ms pulse signal when the watt-hour counter increases by the units selected. 0: 0.1 kWh units 1: 1 kWh units 2: 10 kWh units 3: 100 kWh units 4: 1000 kWh units	Default: 0 Range: 0 to 4	–

H2 Multi-Function Digital Output Settings			
H2-□□ Setting	Function	Description	Page
0	During run	Closed: A Run command is active or voltage is output.	–
1	Zero speed	Open: Output frequency is above the minimum output frequency set in E1-09. Closed: Output frequency is below the minimum output frequency set in E1-09.	–
2	Speed agree 1	Closed: Output frequency equals the speed reference (plus or minus the hysteresis set to L4-02).	103
3	User-set speed agree 1	Closed: Output frequency and speed reference equal L4-01 (plus or minus the hysteresis set to L4-02).	104
4	Frequency detection 1	Closed: Output frequency is less than or equal to the value in L4-01 with hysteresis determined by L4-02.	–
5	Frequency detection 2	Closed: Output frequency is greater than or equal to the value in L4-01 with hysteresis determined by L4-02.	–
6	Drive ready	Closed: Power up is complete and the drive is ready to accept a Run command.	–
7	DC bus undervoltage	Closed: DC bus voltage is below the Uv trip level set in L2-05.	–
8	During baseblock (N.O.)	Closed: Drive has entered the baseblock state (no output voltage).	–
9	Frequency reference source	Open: External Reference 1 or 2 supplies the frequency reference (set in b1-01 or b1-15). Closed: Digital operator supplies the frequency reference.	–
A	Run command source	Open: External Reference 1 or 2 supplies the Run command (set in b1-02 or b1-16). Closed: Digital operator supplies the Run command.	–
B	Torque detection 1 (N.O.)	Closed: An overtorque or undertorque situation has been detected.	–
C	Frequency reference loss	Closed: Analog frequency reference has been lost. Frequency reference loss is detected when the frequency reference drops below 10% of the reference within 400 ms.	–
D	Braking resistor fault	Closed: Braking resistor or transistor is overheated or faulted out.	–
E	Fault	Closed: Fault occurred.	–
F	Through mode	Set this value when using the terminal in the pass-through mode.	–
10	Minor fault	Closed: An alarm has been triggered, or the IGBTs have reached 90% of their expected life span.	–
11	Fault reset command active	Closed: A command has been entered to clear a fault via the input terminals or from the serial network.	–
12	Timer output	Closed: Timer output.	–
13	Speed agree 2	Closed: When drive output frequency equals the frequency reference ±L4-04.	–
14	User-set speed agree 2	Closed: When the drive output frequency is equal to the value in L4-03 ±L4-04.	–
15	Frequency detection 3	Closed: When the drive output frequency is less than or equal to the value in L4-03 ±L4-04.	–

B.6 H Parameters: Multi-Function Terminals

H2 Multi-Function Digital Output Settings			
H2-□□ Setting	Function	Description	Page
16	Frequency detection 4	Closed: When the output frequency is greater than or equal to the value in L4-03 ±L4-04.	–
17	Torque detection 1 (N.C.)	Open: Overtorque or undertorque has been detected.	–
18	Torque detection 2 (N.O.)	Closed: Overtorque or undertorque has been detected.	–
19	Torque detection 2 (N.C.)	Open: Overtorque or undertorque has been detected.	–
1A	During reverse	Closed: Drive is running in the reverse direction.	–
1B	During baseblock (N.C.)	Open: Drive has entered the baseblock state (no output voltage).	–
1E	Restart enabled	Closed: An automatic restart is performed	–
1F	Motor overload alarm (oL1)	Closed: oL1 is at 90% of its trip point or greater. An oH3 situation also triggers this alarm.	–
20	Drive overheat pre-alarm (oH)	Closed: Heatsink temperature exceeds the parameter L8-02 value.	–
22	Mechanical weakening detection	Closed: Mechanical weakening detected.	–
2F	Maintenance period	Closed: Cooling fan, electrolytic capacitors, IGBTs, or the soft charge bypass relay may require maintenance.	–
37	During frequency output	Open: Either the drive has stopped or baseblock, DC Injection Braking, or Initial Excitation is being performed. Closed: Drive is running the motor (not in a baseblock state and DC Injection is not being performed).	–
38	Drive enabled	Closed: Multi-function input set for “Drive enable” is closed (H1-□□ = 6A)	–
39	Watt hour pulse output	Output units are determined by H2-06. Outputs a pulse every 200 ms to indicate the kWh count.	–
3C	LOCAL/REMOTE status	Open: REMOTE Closed: LOCAL	–
3D	During speed search	Closed: Speed Search is being executed.	–
3E	PID feedback low	Closed: PID feedback level is too low.	–
3F	PID feedback high	Closed: The PID feedback level is too high.	–
4A	During KEB Ride-Thru	Closed: KEB Ride-Thru is being performed.	–
4C	During fast stop	Closed: A Fast Stop command has been entered from the operator or input terminals.	–
4D	oH Pre-alarm time limit	Closed: oH pre-alarm time limit has passed.	–
4E	Braking transistor fault (rr)	Closed: The built-in dynamic braking transistor failed.	–
4F	Braking resistor overheat (oH)	Closed: The dynamic braking resistor has overheated.	–
50	Waiting to Run	Closed: b1-11 Timer is active.	–
51	Sequence timer 1 SeqTimer Disable	Closed: Sequence timer 1 is active.	–
52	Sequence timer 2 SeqTimer Cancel	Closed: Sequence timer 2 is active.	–
53	Sequence timer 3 Sequence timer 3	Closed: Sequence timer 3 is active.	–
54	Sequence timer 4 Sequence Timer 4	Closed: Sequence timer 4 is active.	–
58	Underload detection UL6	Closed: Underload is detected.	–
60	Internal cooling fan alarm	Closed: Internal cooling fan alarm	–
71	Secondary PI Feedback Low PI2 Feedback Low	Closed: PI2 feedback level is too low.	–
72	Secondary PI Feedback High PI2 FeedbackHigh	Closed: The PI2 feedback level is too high.	–
100 to 192	Function 0 to 92 with inverse output	Inverts the output switching of the multi-function output functions. Set the last two digits of 1□□ to reverse the output signal of that specific function.	–

◆ H3: Multi-Function Analog Inputs

No. (Addr. Hex)	Name	Description	Values	Page
H3-01 (410)	Terminal A1 Signal Level Selection	0: 0 to 10 V 1: -10 to 10 V 2: 4 to 20 mA 3: 0 to 20 mA Note: Use Jumper S1 to set input terminal A1 for a current or voltage input signal.	Default: 0 Range: 0 to 3	104
H3-02 (434)	Terminal A1 Function Selection	Sets the function of terminal A1.	Default: 0 Range: 0 to 32	104
H3-03 (411) 	Terminal A1 Gain Setting	Sets the level of the input value selected in H3-02 when 10 V is input at terminal A1.	Default: 100.0% Min.: -999.9 Max.: 999.9	104
H3-04 (412) 	Terminal A1 Bias Setting	Sets the level of the input value selected in H3-02 when 0 V is input at terminal A1.	Default: 0.0% Min.: -999.9 Max.: 999.9	104
H3-05 (413)	Terminal A3 Signal Level Selection	0: 0 to 10 V 1: -10 to 10 V 2: 4 to 20 mA 3: 0 to 20 mA Note: Use Jumper S1 to set input terminal A3 for a current or voltage input signal.	Default: 0 Range: 0 to 3	105
H3-06 (414)	Terminal A3 Function Selection	Sets the function of terminal A3.	Default: 2 Range: 0 to 32	105
H3-07 (415) 	Terminal A3 Gain Setting	Sets the level of the input value selected in H3-06 when 10 V is input at terminal A3.	Default: 100.0% Min.: -999.9 Max.: 999.9	105
H3-08 (416) 	Terminal A3 Bias Setting	Sets the level of the input value selected in H3-06 when 0 V is input at terminal A3.	Default: 0.0% Min.: -999.9 Max.: 999.9	105
H3-09 (417)	Terminal A2 Signal Level Selection	0: 0 to 10 V 1: -10 to 10 V 2: 4 to 20 mA 3: 0 to 20 mA Note: Use Jumper S1 to set input terminal A2 for a current or voltage input signal.	Default: 2 Range: 0 to 3	106
H3-10 (418)	Terminal A2 Function Selection	Sets the function of terminal A2.	Default: 0 Range: 0 to 32	106
H3-11 (419) 	Terminal A2 Gain Setting	Sets the level of the input value selected in H3-10 when 10 V (20 mA) is input at terminal A2.	Default: 100.0% Min.: -999.9 Max.: 999.9	106
H3-12 (41A) 	Terminal A2 Bias Setting	Sets the level of the input value selected in H3-10 when 0 V (0 or 4 mA) is input at terminal A2.	Default: 0.0% Min.: -999.9 Max.: 999.9	106
H3-13 (41B)	Analog Input Filter Time Constant	Sets a primary delay filter time constant for terminals A1, A2, and A3. Used for noise filtering.	Default: 0.03 s Min.: 0.00 Max.: 2.00	–
H3-14 (41C)	Analog Input Terminal Enable Selection	Determines which analog input terminals will be enabled when a digital input programmed for “Analog input enable” (H1-□□ = C) is activated. 1: Terminal A1 only 2: Terminal A2 only 3: Terminals A1 and A2 only 4: Terminal A3 only 5: Terminals A1 and A3 6: Terminals A2 and A3 7: All terminals enabled	Default: 7 Range: 1 to 7	–
H3-16 (2F0)	Terminal A1 Offset	Adds an offset when the analog signal to terminal A1 is at 0 V.	Default: 0 Min.: -500 Max.: 500	–



B.6 H Parameters: Multi-Function Terminals



No. (Addr. Hex)	Name	Description	Values	Page
H3-17 (2F1)	Terminal A2 Offset	Adds an offset when the analog signal to terminal A2 is at 0 V.	Default: 0 Min.: -500 Max.: 500	–
H3-18 (2F2)	Terminal A3 Offset	Adds an offset when the analog signal to terminal A3 is at 0 V.	Default: 0 Min.: -500 Max.: 500	–

H3 Multi-Function Analog Input Settings

H3-□□ Setting	Function	Description	Page
0	Frequency bias	10 V = E1-04 (maximum output frequency)	–
1	Frequency gain	0 to 10 V signal allows a setting of 0 to 100%. -10 to 0 V signal allows a setting of -100 to 0%.	–
2	Auxiliary frequency reference 1	10 V = E1-04 (maximum output frequency)	–
3	Auxiliary frequency reference 2	10 V = E1-04 (maximum output frequency)	–
4	Output voltage bias	10 V = E1-05 (motor rated voltage)	–
5	Accel/decel time gain	10 V = 100%	–
6	DC Injection Braking current	10 V = Drive rated current	–
7	Overtorque/undertorque detection level	10 V = Drive rated current (V/f)	–
8	Stall Prevention level during run	10 V = Drive rated current	–
9	Output frequency lower limit level	10 V = E1-04 (maximum output frequency)	–
B	PID feedback	10 V = 100%	–
C	PID setpoint	10 V = 100%	–
D	Frequency bias	10 V = E1-04 (maximum output frequency)	–
E	Motor Temperature (PTC Input)	10 V = 100% Note: A 12 kΩ resistor must be connected between terminals A1, A2, or A3 and V+ for PTC functionality.	–
16	Differential PID feedback	10 V = 100%	–
17	Motor Thermistor (NTC)	10 V = -9 °C 0 V = 234 °C	–
1F	Through mode	Set this value when using the terminal in the pass-through mode.	–
25	Secondary PI Setpoint PI2 Setpoint	10 V = S3-02 (maximum output frequency)	–
26	Secondary PI Feedback PI2 Feedback	10 V = S3-02 (maximum output frequency)	–

◆ H4: Analog Outputs

No. (Addr. Hex)	Name	Description	Values	Page
H4-01 (41D)	Multi-Function Analog Output Terminal FM Monitor Selection	Selects the data to be output through multi-function analog output terminal FM. Set the desired monitor parameter to the digits available in U□-□□. For example, enter “103” for U1-03.	Default: 102 Range: 000 to 999	106
H4-02 (41E) 	Multi-Function Analog Output Terminal FM Gain	Sets the signal level at terminal FM that is equal to 100% of the selected monitor value.	Default: 100.0% Min.: -999.9 Max.: 999.9	107
H4-03 (41F) 	Multi-Function Analog Output Terminal FM Bias	Sets the signal level at terminal FM that is equal to 0% of the selected monitor value.	Default: 0.0% Min.: -999.9 Max.: 999.9	107
H4-04 (420)	Multi-Function Analog Output Terminal AM Monitor Selection	Selects the data to be output through multi-function analog output terminal AM. Set the desired monitor parameter to the digits available in U□-□□. For example, enter “103” for U1-03.	Default: 103 Range: 000 to 999	106





No. (Addr. Hex)	Name	Description	Values	Page
H4-05 (421) 	Multi-Function Analog Output Terminal AM Gain	Sets the signal level at terminal AM that is equal to 100% of the selected monitor value.	Default: 50.0% Min.: -999.9 Max.: 999.9	107
H4-06 (422) 	Multi-Function Analog Output Terminal AM Bias	Sets the signal level at terminal AM that is equal to 0% of the selected monitor value.	Default: 0.0% Min.: -999.9 Max.: 999.9	107
H4-07 (423)	Multi-Function Analog Output Terminal FM Signal Level Selection	0: 0 to 10 V 1: -10 to 10 V 2: 4 to 20mA	Default: 0 Range: 0 to 2	108
H4-08 (424)	Multi-Function Analog Output Terminal AM Signal Level Selection	0: 0 to 10 V 1: -10 to 10 V 2: 4 to 20 mA	Default: 0 Range: 0 to 2	108

◆ H5: MEMOBUS/Modbus Serial Communication

No. (Addr. Hex)	Name	Description	Values	Page
H5-01 (425) <>	Drive Node Address	Selects drive station node number (address) for MEMOBUS/Modbus terminals R+, R-, S+, S-. Cycle power for the setting to take effect.	Default: 1F (Hex) Min.: 0 Max.: FF	-
H5-02 (426)	Communication Speed Selection	0: 1200 bps 1: 2400 bps 2: 4800 bps 3: 9600 bps 4: 19200 bps 5: 38400 bps 6: 57600 bps 7: 76800 bps 8: 115200 bps Cycle power for the setting to take effect.	Default: 3 Range: 0 to 8	-
H5-03 (427)	Communication Parity Selection	0: No parity 1: Even parity 2: Odd parity Cycle power for the setting to take effect.	Default: 0 Range: 0 to 2	-
H5-04 (428)	Stopping Method after Communication Error (CE)	0: Ramp to stop 1: Coast to stop 2: Fast Stop 3: Alarm only	Default: 3 Range: 0 to 3	-
H5-05 (429)	Communication Fault Detection Selection	0: Disabled 1: Enabled. If communication is lost for more than two seconds, a CE fault will occur.	Default: 1 Range: 0, 1	-
H5-06 (42A)	Drive Transmit Wait Time	Set the wait time between receiving and sending data.	Default: 5 ms Min.: 5 Max.: 65	-
H5-07 (42B)	RTS Control Selection	0: Disabled. RTS is always on. 1: Enabled. RTS turns on only when sending.	Default: 1 Range: 0, 1	-
H5-09 (435)	CE Detection Time	Sets the time required to detect a communications error. Adjustment may be needed when networking several drives.	Default: 2.0 s Min.: 0.0 Max.: 10.0	-
H5-10 (436)	Unit Selection for MEMOBUS/Modbus Register 0025H	0: 0.1 V units 1: 1 V units	Default: 0 Range: 0, 1	-
H5-11 (43C)	Communications ENTER Function Selection	0: Drive requires an Enter command before accepting any changes to parameter settings. 1: Parameter changes are activated immediately without the Enter command.	Default: 1 Range: 0, 1	-
H5-12 (43D)	Run Command Method Selection	0: FWD/Stop, REV/Stop 1: Run/Stop, FWD/REV	Default: 0 Range: 0, 1	-

<1> If this parameter is set to 0, the drive will be unable to respond to MEMOBUS/Modbus commands.

◆ H6: Pulse Train Input

No. (Addr. Hex)	Name	Description	Values	Page
H6-01 (42C)	Pulse Train Input Terminal RP Function Selection	0: Frequency reference 1: PID feedback value 2: PID setpoint value	Default: 0 Range: 0 to 2	–
H6-02 (42D) 	Pulse Train Input Scaling	Sets the terminal RP input signal frequency that is equal to 100% of the value selected in H6-01.	Default: 1440 Hz Min.: 100 Max.: 32000	–
H6-03 (42E) 	Pulse Train Input Gain	Sets the level of the value selected in H6-01 when a frequency with the value set in H6-02 is input.	Default: 100.0% Min.: 0.0 Max.: 1000.0	–
H6-04 (42F) 	Pulse Train Input Bias	Sets the level of the value selected in H6-01 when 0 Hz is input.	Default: 0.0% Min.: -100.0 Max.: 100.0	–
H6-05 (430) 	Pulse Train Input Filter Time	Sets the pulse train input filter time constant.	Default: 0.10 s Min.: 0.00 Max.: 2.00	–
H6-08 (43F)	Pulse Train Input Minimum Frequency	Sets the minimum frequency for the pulse train input to be detected. Enabled when H6-01 = 0, 1, or 2.	Default: 0.5 Hz Min.: 0.1 Max.: 1000.0	–

B.7 L: Protection Function

L parameters provide protection to the drive and motor, including control during momentary power loss, Stall Prevention, frequency detection, fault restarts, overtorque detection, and other types of hardware protection.

◆ L1: Motor Protection

No. (Addr. Hex)	Name	Description	Values	Page
L1-01 (480)	Motor Overload Protection Selection	0: Disabled 1: General purpose motor (standard fan cooled) 2: Drive dedicated motor with a speed range of 1:10 3: Vector motor with a speed range of 1:100 6: General purpose motor (50 Hz) The drive may not be able to provide protection when using multiple motors, even if overload is enabled in L1-01. Set L1-01 to 0 and install separate thermal relays to each motor.	Default: 1 Range: 0 to 6	–
L1-02 (481)	Motor Overload Protection Time	Sets the motor thermal overload protection (oL1) time.	Default: 1.0 min Min.: 0.1 Max.: 5.0	–
L1-03 (482)	Motor Overheat Alarm Operation Selection (PTC input)	Sets operation when the motor temperature analog input (H3-02, H3-10, or H3-06 = E) exceeds the oH3 alarm level. 0: Ramp to stop 1: Coast to stop 2: Fast Stop (decelerate to stop using the deceleration time in C1-09) 3: Alarm only (“oH3” will flash)	Default: 3 Range: 0 to 3	–
L1-04 (483)	Motor Overheat Fault Operation Selection (PTC input)	Sets stopping method when the motor temperature analog input (H3-02, H3-10, or H3-06 = E) exceeds the oH4 fault level. 0: Ramp to stop 1: Coast to stop 2: Fast Stop (decelerate to stop using the deceleration time in C1-09)	Default: 1 Range: 0 to 2	–
L1-05 (484)	Motor Temperature Input Filter Time (PTC input)	Adjusts the filter for the motor temperature analog input (H3-02, H3-10, or H3-06 = E).	Default: 0.20 s Min.: 0.00 Max.: 10.00	–
L1-13 (46D)	Continuous Electrothermal Operation Selection	0: Disabled 1: Enabled 2: Enabled (RTC)	Default: 1 Range: 0 to 2	–

◆ L2: Momentary Power Loss Ride-Thru

No. (Addr. Hex)	Name	Description	Values	Page
L2-01 (485)	Momentary Power Loss Operation Selection	0: Disabled. Drive trips on Uv1 fault when power is lost. 1: Recover within the time set in L2-02. Uv1 will be detected if power loss is longer than L2-02. 2: Recover as long as CPU has power. Uv1 is not detected. 3: KEB deceleration for the time set to L2-02. 4: KEB deceleration as long as CPU has power. 5: KEB deceleration to stop.	Default: 2 Range: 0 to 5	–
L2-02 (486)	Momentary Power Loss Ride-Thru Time	Sets the Power Loss Ride-Thru time. Enabled only when L2-01 = 1 or 3.	Default: </> Min.: 0.0 s Max.: 25.5 s	–
L2-03 (487)	Momentary Power Loss Minimum Baseblock Time	Sets the minimum wait time for residual motor voltage decay before the drive output reenergizes after performing Power Loss Ride-Thru. Increasing the time set to L2-03 may help if overcurrent or overvoltage occur during Speed Search or during DC Injection Braking.	Default: </> Min.: 0.1 s Max.: 5.0 s	–
L2-04 (488)	Momentary Power Loss Voltage Recovery Ramp Time	Sets the time for the output voltage to return to the preset V/f pattern during Speed Search.	Default: </> Min.: 0.0 s Max.: 5.0 s	–

B.7 L: Protection Function

No. (Addr. Hex)	Name	Description	Values	Page
L2-05 (489)	Undervoltage Detection Level (Uv1)	Sets the DC bus undervoltage trip level.	Default: 190 Vdc <2> <3> Min.: 150 Vdc Max.: 210 Vdc <3>	–
L2-06 (48A)	KEB Deceleration Time	Sets the time required to decelerate from the speed when KEB was activated to zero speed.	Default: 0.00 s Min.: 0.00 Max.: 6000.0 <4>	–
L2-07 (48B)	KEB Acceleration Time	Sets the time to accelerate to the frequency reference when momentary power loss is over. If set to 0.0, the active acceleration time is used.	Default: 0.00 s Min.: 0.00 Max.: 6000.0 <4>	–
L2-08 (48C)	Frequency Gain at KEB Start	Sets the percentage of output frequency reduction at the beginning of deceleration when the KEB Ride-Thru function is started. Reduction = (slip frequency before KEB) × L2-08 × 2	Default: 100% Min.: 0 Max.: 300	–
L2-10 (48E)	KEB Detection Time (Minimum KEB Time)	Sets the time to perform KEB Ride-Thru.	Default: 50 ms Min.: 0 Max.: 2000	–
L2-11 (461)	DC Bus Voltage Setpoint during KEB	Sets the desired value of the DC bus voltage during KEB Ride-Thru.	Default: <2> [E1-01] × 1.22 Min.: 150 Vdc Max.: 400 Vdc <5>	–
L2-29 (475)	KEB Method Selection	0: Single Drive KEB Ride-Thru 1 1: Single Drive KEB Ride-Thru 2 2: System KEB Ride-Thru 1 3: System KEB Ride-Thru 2	Default: 0 Range: 0 to 3	–

<1> Default setting is dependent on parameter o2-04, Drive Model Selection.

<2> Default setting is dependent on parameter E1-01, Input voltage Setting.

<3> Values shown are specific to 200 V class drives. Double the value for 400 V class drives. Multiply the value by 2.875 for 600 V class drives.

<4> Setting range value is dependent on parameter C1-10, Accel/Decel Time Setting Units. When C1-10 = 0 (units of 0.01 seconds), the setting range becomes 0.00 to 600.00 seconds.

<5> Values shown are specific to 200 V class drives. Double the value for 400 V class drives. Multiply the value by 2.875 for 600 V class drives, but set the value below 1040 Vdc (overvoltage protection level).

◆ L3: Stall Prevention

No. (Addr. Hex)	Name	Description	Values	Page
L3-01 (48F)	Stall Prevention Selection during Acceleration	0: Disabled. 1: General purpose. Acceleration is paused as long as the current is above the L3-02 setting. 2: Intelligent. Accelerate in the shortest possible time without exceeding the L3-02 level.	Default: 1 Range: 0 to 2	108
L3-02 (490)	Stall Prevention Level during Acceleration	Used when L3-01 = 1 or 2. 100% is equal to the drive rated current.	Default: <1> Min.: 0% Max.: 150% <1>	109
L3-03 (491)	Stall Prevention Limit during Acceleration	Sets Stall Prevention lower limit during acceleration when operating in the constant power range. Set as a percentage of drive rated current.	Default: 50% Min.: 0 Max.: 100	109
L3-04 (492)	Stall Prevention Selection during Deceleration	0: Disabled. Deceleration at the active deceleration rate. An ov fault may occur. 1: General purpose. Deceleration is paused when the DC bus voltage exceeds the Stall Prevention level. 2: Intelligent. Decelerate as fast as possible while avoiding ov faults. 3: Stall Prevention with braking resistor. Stall Prevention during deceleration is enabled in coordination with dynamic braking. 4: Overexcitation Deceleration. Decelerates while increasing the motor flux. 5: Overexcitation Deceleration 2. Adjust the deceleration rate according to the DC bus voltage.	Default: 1 Range: 0 to 5	110

No. (Addr. Hex)	Name	Description	Values	Page
L3-05 (493)	Stall Prevention Selection during Run	0: Disabled. Drive runs at a set frequency. A heavy load may cause speed loss. 1: Decel time 1. Uses the deceleration time set to C1-02 while Stall Prevention is performed. 2: Decel time 2. Uses the deceleration time set to C1-04 while Stall Prevention is performed.	Default: 1 Range: 0 to 2	111
L3-06 (494)	Stall Prevention Level during Run	Enabled when L3-05 is set to 1 or 2. 100% is equal to the drive rated current.	Default: <1> Min.: 30% Max.: 150% <2>	111
L3-11 (4C7)	Overvoltage Suppression Function Selection	Enables or disables the ov suppression function, which allows the drive to change the output frequency as the load changes to prevent an ov fault. 0: Disabled 1: Enabled	Default: 0 Range: 0, 1	-
L3-17 (462)	Target DC Bus Voltage for Overvoltage Suppression and Stall Prevention	Sets the desired value for the DC bus voltage during overvoltage suppression and Stall Prevention during deceleration.	Default: 375 Vdc <2> <3> Min.: 150 Max.: 400 <3>	-
L3-20 (465)	DC Bus Voltage Adjustment Gain	Sets the proportional gain for KEB Ride-Thru, Stall Prevention, and overvoltage suppression.	Default: 1.00 Min.: 0.00 Max.: 5.00	-
L3-21 (466)	Accel/Decel Rate Calculation Gain	Sets the proportional gain used to calculate the deceleration rate during KEB Ride-Thru, ov suppression function, and Stall Prevention during deceleration (L3-04 = 2).	Default: 1.00 Min.: 0.10 Max.: 10.00	-
L3-23 (4FD)	Automatic Reduction Selection for Stall Prevention during Run	0: Sets the Stall Prevention level set in L3-04 that is used throughout the entire frequency range. 1: Automatic Stall Prevention level reduction in the constant output range. The lower limit value is 40% of L3-06.	Default: 0 Range: 0, 1	-
L3-24 (46E)	Motor Acceleration Time for Inertia Calculations	Sets the time needed to accelerate the uncoupled motor at rated torque from stop to the maximum frequency.	Default: <4> <5> Min: 0.001 s Max: 10.000 s	-
L3-25 (46F)	Load Inertia Ratio	Sets the ratio between the motor and machine inertia.	Default: 1.0 Min.: 1.0 Max.: 1000.0	-
L3-26 (455)	Additional DC Bus Capacitors	When DC bus capacitors have been added externally, be sure to add those values to the internal capacitor table for proper DC bus calculations.	Default: 0 μF Min: 0 Max: 65000	-
L3-27 (456)	Stall Prevention Detection Time	Sets the time the current must exceed the Stall Prevention level to activate Stall Prevention.	Default: 50 ms Min.: 0 Max.: 5000	-

<1> Upper limit is dependent on parameter L8-38, Frequency Reduction Selection.

<2> Default setting is dependent on parameter E1-01, Input voltage Setting.

<3> Values shown are specific to 200 V class drives. Double the value for 400 V class drives. Multiply the value by 2.875 for 600 V class drives, but set the value below 1040 Vdc (overvoltage protection level).

<4> Parameter value changes automatically if E2-11 is manually changed or changed by Auto-Tuning.

<5> Default setting is dependent on parameter o2-04, Drive Model Selection.

◆ L4: Speed Detection

No. (Addr. Hex)	Name	Description	Values	Page
L4-01 (499)	Speed Agreement Detection Level	L4-01 sets the frequency detection level for digital output functions H2-□□ = 2, 3, 4, 5.	Default: 0.0 Hz Min.: 0.0 Max.: 400.0	-
L4-02 (49A)	Speed Agreement Detection Width	L4-02 sets the hysteresis or allowable margin for speed detection.	Default: 2.0 Min.: 0.0 Max.: 20.0	-
L4-03 (49B)	Speed Agreement Detection Level (+/-)	L4-03 sets the frequency detection level for digital output functions H2-□□ = 13, 14, 15, 16.	Default: 0.0 Hz Min.: -400.0 Max.: 400.0	-

B.7 L: Protection Function

No. (Addr. Hex)	Name	Description	Values	Page
L4-04 (49C)	Speed Agreement Detection Width (+/-)	L4-04 sets the hysteresis or allowable margin for speed detection.	Default: 2.0 Min.: 0.0 Max.: 20.0	-
L4-05 (49D)	Frequency Reference Loss Detection Selection	0: Stop. Drive stops when the frequency reference is lost. 1: Run. Drive runs at a reduced speed when the frequency reference is lost.	Default: 0 Range: 0, 1	-
L4-06 (4C2)	Frequency Reference at Reference Loss	Sets the percentage of the frequency reference that the drive should run with when the frequency reference is lost.	Default: 80.0% Min.: 0.0 Max.: 100.0	-
L4-07 (470)	Speed Agreement Detection Selection	0: No detection during baseblock. 1: Detection always enabled.	Default: 0 Range: 0, 1	-

◆ L5: Fault Restart

No. (Addr. Hex)	Name	Description	Values	Page
L5-01 (49E)	Number of Auto Restart Attempts	Sets the number of times the drive may attempt to restart after the following faults occur: GF, LF, oC, ov, PF, rH, rr, oL1, oL2, oL3, oL4, STo, Uv1.	Default: 0 Min.: 0 Max.: 10	-
L5-02 (49F)	Auto Restart Fault Output Operation Selection	0: Fault output not active. 1: Fault output active during restart attempt.	Default: 0 Range: 0, 1	-
L5-04 (46C)	Fault Reset Interval Time	Sets the amount of time to wait between performing fault restarts.	Default: 10.0 s Min.: 0.5 Max.: 600.0	-
L5-05 (467)	Fault Reset Operation Selection	0: Continuously attempt to restart while incrementing restart counter only at a successful restart (same as F7 and G7). 1: Attempt to restart with the interval time set in L5-04 and increment the restart counter with each attempt (same as V7).	Default: 0 Range: 0, 1	-

◆ L6: Torque Detection

No. (Addr. Hex)	Name	Description	Values	Page
L6-01 (4A1)	Torque Detection Selection 1	0: Disabled 1: oL3 detection only active during speed agree, operation continues after detection 2: oL3 detection always active during run, operation continues after detection 3: oL3 detection only active during speed agree, output shuts down on an oL3 fault 4: oL3 detection always active during run, output shuts down on an oL3 fault 5: UL3 detection only active during speed agree, operation continues after detection 6: UL3 detection always active during run, operation continues after detection 7: UL3 detection only active during speed agree, output shuts down on an oL3 fault 8: UL3 detection always active during run, output shuts down on an oL3 fault 9: UL6 Alarm at Speed Agree 10: UL6 Alarm during Run 11: UL6 Fault at Speed Agree 12: UL6 Fault during Run	Default: 0 Range: 0 to 12	-
L6-02 (4A2)	Torque Detection Level 1	Sets the overtorque and undertorque detection level.	Default: 15% Min.: 0 Max.: 300	-
L6-03 (4A3)	Torque Detection Time 1	Sets the time an overtorque or undertorque condition must exist to trigger torque detection 1.	Default: 10.0 s Min.: 0.0 Max.: 10.0	-

No. (Addr. Hex)	Name	Description	Values	Page
L6-04 (4A4)	Torque Detection Selection 2	0: Disabled 1: oL4 detection only active during speed agree, operation continues after detection 2: oL4 detection always active during run, operation continues after detection 3: oL4 detection only active during speed agree, output shuts down on an oL4 fault 4: oL4 detection always active during run, output shuts down on an oL4 fault 5: UL4 detection only active during speed agree, operation continues after detection 6: UL4 detection always active during run, operation continues after detection 7: UL4 detection only active during speed agree, output shuts down on an oL4 fault 8: UL4 detection always active during run, output shuts down on an oL4 fault	Default: 0 Range: 0 to 8	–
L6-05 (4A5)	Torque Detection Level 2	Sets the overtorque and undertorque detection level.	Default: 150% Min.: 0 Max.: 300	–
L6-06 (4A6)	Torque Detection Time 2	Sets the time an overtorque or undertorque condition must exist to trigger torque detection 2.	Default: 0.1 s Min.: 0.0 Max.: 10.0	–
L6-13 (62E)	Motor Underload Protection Selection Underload Select	Sets the motor underload protection (UL6) based on motor load. 0: Base frequency enable 0: Base Freq Enable 1: Max frequency enable 1: Max Freq Enable	Default: 0 Range: 0, 1	–
L6-14 (62F)	Motor Underload Protection Level at Minimum Frequency Underload Level	Sets the UL6 detection level at minimum frequency by percentage of drive rated current.	Default: 15% Min.: 0 Max.: 300	–

◆ L8: Drive Protection

No. (Addr. Hex)	Name	Description	Values	Page
L8-01 (4AD)	Internal Dynamic Braking Resistor Protection Selection (ERF type)	0: Resistor overheat protection disabled 1: Resistor overheat protection enabled	Default: 0 Range: 0, 1	–
L8-02 (4AE)	Overheat Alarm Level	An overheat alarm occurs when heatsink temperature exceeds the L8-02 level.	Default: <> Min.: 50 °C Max.: 150 °C	–
L8-03 (4AF)	Overheat Pre-Alarm Operation Selection	0: Ramp to stop. A fault is triggered. 1: Coast to stop. A fault is triggered. 2: Fast Stop. Decelerate to stop using the deceleration time in C1-09. A fault is triggered. 3: Continue operation. An alarm is triggered. 4: Continue operation at reduced speed as set in L8-19.	Default: 3 Range: 0 to 4	–
L8-05 (4B1)	Input Phase Loss Protection Selection	Selects the detection of input current phase loss, power supply voltage imbalance, or main circuit electrolytic capacitor deterioration. 0: Disabled 1: Enabled	Default: 1 Range: 0, 1	–
L8-07 (4B3)	Output Phase Loss Protection Selection	0: Disabled 1: Enabled (triggered by a single phase loss) 2: Enabled (triggered when two phases are lost)	Default: 1 Range: 0 to 2	–
L8-09 (4B5)	Output Ground Fault Detection Selection	0: Disabled 1: Enabled	Default: 1 Range: 0, 1	–
L8-10 (4B6)	Heatsink Cooling Fan Operation Selection	0: During run only. Fan operates only during run for L8-11 seconds after stop. 1: Fan always on. Cooling fan operates whenever the drive is powered up.	Default: 0 Range: 0, 1	–
L8-11 (4B7)	Heatsink Cooling Fan Off Delay Time	Sets a delay time to shut off the cooling fan after the Run command is removed when L8-10 = 0.	Default: 60 s Min.: 0 Max.: 300	–
L8-12 (4B8)	Ambient Temperature Setting	Enter the ambient temperature. This value adjusts the oL2 detection level.	Default: 40 °C Min.: -10 Max.: 50	–
L8-15 (4BB)	oL2 Characteristics Selection at Low Speeds	0: No oL2 level reduction below 6 Hz. 1: oL2 level is reduced linearly below 6 Hz. It is halved at 0 Hz.	Default: 1 Range: 0, 1	–
L8-18 (4BE)	Software Current Limit Selection	0: Disabled 1: Enabled	Default: 0 Range: 0, 1	–
L8-19 (4BF)	Frequency Reduction Rate during Overheat Pre-Alarm	Specifies the frequency reference reduction gain at overheat pre-alarm when L8-03 = 4.	Default: 0.8 Min.: 0.1 Max.: 0.9	–
L8-32 (4E2)	Main Contactor and Cooling Fan Power Supply Failure Selection	Determines drive response when a fault occurs with the internal cooling fan. 0: Ramp to stop 1: Coast to stop 2: Fast stop (Decelerate to stop using the deceleration time set to C1-09) 3: Alarm only (“FAN” will flash) 4: Continue operation at reduced speed as set to L8-19.	Default: 1 Range: 0 to 4	–
L8-35 (4EC)	Installation Method Selection	0: IP00/Open-Chassis enclosure 1: Side-by-Side mounting 2: IP20/NEMA Type 1 enclosure 3: Finless model drive or external heatsink installation	Default: <> <3> Range: 0 to 3	–
L8-38 (4EF)	Carrier Frequency Reduction	0: Disabled 1: Enabled below 6 Hz 2: Enabled for the entire speed range	Default: 2 Range: 0 to 2	–
L8-40 (4F1)	Carrier Frequency Reduction Off Delay Time	Sets the time that the drive continues running with reduced carrier frequency after the carrier reduction condition is gone. Setting 0.00 s disables the carrier frequency reduction time.	Default: 0.5 s Min.: 0.00 Max.: 2.00	–
L8-41 (4F2)	High Current Alarm Selection	0: Disabled 1: Enabled. An alarm is triggered at output currents above 150% of drive rated current.	Default: 0 Range: 0, 1	–
L8-55 (45F)	Internal Braking Transistor Protection	0: Disabled. Disable when using a regen converter or optional braking unit. 1: Protection enabled.	Default: 1 Range: 0, 1	–
L8-93 (73C)	LSo Detection Time at Low Speed	Sets the amount of time until baseblock is executed after detecting pull-out at low speed.	Default: 1.0 s Min.: 0.0 Max.: 10.0	–

No. (Addr. Hex)	Name	Description	Values	Page
L8-94 (73D)	LSo Detection Level at Low Speed	Determines the detection level of pull-out at low speed.	Default: 3% Min.: 0 Max.: 10	-
L8-95 (73D)	Average LSo Frequency at Low Speed	Sets the average number of times pull-out can occur at low speed.	Default: 10 times Min.: 1 Max.: 50	-

- <1> Default setting is dependent on parameter o2-04, Drive Model Selection.
- <2> Parameter setting value is not reset to the default value when the drive is initialized.
- <3> Default setting is determined by the drive model:
 Setting 2: Model code CIMR-P□2A0004 to 2A0211, 4A0002 to 4A0165, and 5A0003 to 5A0242
 Setting 0: Model code CIMR-P□2A0250 to 2A0415 and 4A0208 to 4A0675

B.8 n: Special Adjustment

The n parameters adjust more advanced performance characteristics such as Hunting Prevention, High Slip Braking, and Overexcitation Braking.

◆ n1: Hunting Prevention

No. (Addr. Hex)	Name	Description	Values	Page
n1-01 (580)	Hunting Prevention Selection	0: Disabled 1: Enabled	Default: 1 Range: 0, 1	–
n1-02 (581)	Hunting Prevention Gain Setting	If the motor vibrates while lightly loaded, increase the gain by 0.1 until vibration ceases. If the motor stalls, decrease the gain by 0.1 until the stalling ceases.	Default: 1.00 Min.: 0.00 Max.: 2.50	–
n1-03 (582)	Hunting Prevention Time Constant	Sets the time constant used for Hunting Prevention.	Default: </> Min.: 0 ms Max.: 500 ms	–
n1-05 (530)	Hunting Prevention Gain while in Reverse	Sets the gain used for Hunting Prevention. If set to 0, the gain set to n1-02 is used for operation in reverse.	Default: 0.00 Min.: 0.00 Max.: 2.50	–

<1> Default setting is dependent on parameter o2-04, Drive Model Selection.

◆ n3: High Slip Braking (HSB) and Overexcitation Braking

No. (Addr. Hex)	Name	Description	Values	Page
n3-01 (588)	High-Slip Braking Deceleration Frequency Width	Sets the output frequency reduction step width for when the drive stops the motor using HSB. Set as a percentage of the maximum output frequency. Increase this setting if overvoltage occurs during HSB.	Default: 5% Min.: 1 Max.: 20	–
n3-02 (589)	High-Slip Braking Current Limit	Sets the current limit during HSB as a percentage of the motor rated current.	Default: </> Min.: 100% Max.: 200%	–
n3-03 (58A)	High-Slip Braking Dwell Time at Stop	Sets the time the drive will run with minimum frequency (E1-09) at the end of deceleration. If this time is set too low, the machine inertia can cause the motor to rotate slightly after HSB.	Default: 1.0 s Min.: 0.0 Max.: 10.0	–
n3-04 (58B)	High-Slip Braking Overload Time	Sets the time required for an HSB overload fault (oL7) to occur when the drive output frequency does not change during an HSB stop. This parameter does not typically require adjustment.	Default: 40 s Min.: 30 Max.: 1200	–
n3-13 (531)	Overexcitation Deceleration Gain	Sets the gain applied to the V/f pattern during Overexcitation Deceleration (L3-04 = 4).	Default: 1.10 Min.: 1.00 Max.: 1.40	–
n3-14 (532)	High Frequency Injection during Overexcitation Deceleration	0: Disabled 1: Enabled	Default: 0 Range: 0, 1	–
n3-21 (579)	High-Slip Suppression Current Level	Sets output current level at which the drive will start reducing the overexcitation gain in order to prevent a too high motor slip during Overexcitation Deceleration. Set as a percentage of the drive rated current.	Default: 100% Min.: 0 Max.: 150	–
n3-23 (57B)	Overexcitation Operation Selection	0: Enabled in both directions 1: Enabled only when rotating forward 2: Enabled only when in reverse	Default: 0 Range: 0 to 2	–

<1> Default setting is dependent on parameter L8-38, Frequency Reduction Selection.

B.9 o: Operator-Related Settings

The o parameters set up the digital operator displays.

◆ o1: Digital Operator Display Selection

No. (Addr. Hex)	Name	Description	Values	Page
o1-01 (500) 	Drive Mode Unit Monitor Selection	Selects the content of the last monitor that is shown when scrolling through Drive Mode display. Enter the last three digits of the monitor parameter number to be displayed: U□-□□.	Default: 106 (Monitor U1-06) Range: 104 to 809	-
o1-02 (501) 	User Monitor Selection after Power Up	1: Frequency reference (U1-01) 2: Direction 3: Output frequency (U1-02) 4: Output current (U1-03) 5: User-selected monitor (set by o1-01)	Default: 1 Range: 1 to 5	-
o1-03 (502)	Digital Operator Display Selection	Sets the units the drive should use to display the frequency reference and motor speed monitors. 0: 0.01 Hz 1: 0.01% (100% = E1-04) 2: r/min (calculated using the number of motor poles setting in E2-04) 3: User-selected units (set by o1-09, o1-10 and o1-11)	Default: 0 Range: 0 to 3	-
o1-06 (517)	User Monitor Selection Mode Monitor Mode Sel	Selects the monitors displayed on the second and third lines of the digital operator display. 0: 3 Monitor Sequential (displays the next two sequential monitors) Sequential 1: 3 Monitor Selectable 1: 3 Mon Selectable (set by o1-07 and o1-08)	Default: 0 Range: 0, 1	-
o1-07 (518)	Second Line Monitor Selection 2nd Monitor Sel	Selects the monitor that is shown in the second line. Enter the last three digits of the monitor parameter number to be displayed: U□-□□. For example, set "403" to display monitor parameter U4-03. Note: Parameter is effective only when o1-06 is set to 1.	Default: 102 Range: 101 to 799	-
o1-08 (519)	Third Line Monitor Selection 3rd Monitor Sel	Selects the monitor that is shown in the third line. Enter the last three digits of the monitor parameter number to be displayed: U□-□□. For example, set "403" to display monitor parameter U4-03. Note: Parameter is effective only when o1-06 is set to 1.	Default: 103 Range: 101 to 799	-
o1-09 (51C)	Frequency Reference Display Units Fref Disp Unit	Sets unit display for the frequency reference parameters and frequency related monitors when o1-03 = 3. 0: WC 0: WC (Inch of water) 1: PSI 1: PSI (Pounds per square inch) 2: GPM 2: GPM (Gallons per minute) 3: F 3: °F (Degrees Fahrenheit) 4: CFM 4: CFM (Cubic feet per minute) 5: CMH 5: CMH (Cubic meters per hour) 6: LPH 6: LPH (Liters per hour) 7: LPS 7: LPS (Liters per second) 8: Bar 8: Bar (Bar) 9: Pa 9: Pa (Pascal) 10: C 10: °C (Degrees Celsius) 11: Mtr 11: Mtr (Meters) 12: Ft 12: Ft (Feet) 13: LPM 13: LPM (Liters per minute) 14: CMM 14: CMM (Cubic meters per minute) 15: "Hg 15: Hg (inches of mercury) 24: Custom units (determined by o1-13 to o1-15) 25: None 25: No Unit	Default: 25 Range: 0 to 15; 24, 25	-
o1-10 (520)	User-Set Display Units Maximum Value	These settings define the display values when o1-03 is set to 3. o1-10 sets the display value that is equal to the maximum output frequency. o1-11 sets the position of the decimal position.	Default: </> Range: 1 to 60000	-
o1-11 (521)	User-Set Display Units Decimal Display		Default: </> Range: 0 to 3	-
o1-13 (3105)	Frequency Reference and Frequency Related Monitor Custom Units 1 Fref Cust Unit 1	Sets the first character of the customer-specified unit display when o1-03 is set to 3 and o1-09 is set to 24.	Default: 41 Range: 30 to 7A	-

B.9 o: Operator-Related Settings

No. (Addr. Hex)	Name	Description	Values	Page
o1-14 (3106)	Frequency Reference and Frequency Related Monitor Custom Units 2 Fref Cust Unit 2	Sets the second character of the customer-specified unit display when o1-03 is set to 3 and o1-09 is set to 24.	Default: 41 Range: 30 to 7A	–
o1-15 (3107)	Frequency Reference and Frequency Related Monitor Custom Units 3 Fref Cust Unit 3	Sets the third character of the customer-specified unit display when o1-03 is set to 3 and o1-09 is set to 24.	Default: 41 Range: 30 to 7A	–

<1> Default setting is dependent on parameter o1-03, Digital Operator Display Selection.

◆ o2: Digital Operator Keypad Functions

No. (Addr. Hex)	Name	Description	Values	Page
o2-01 (505)	LO/RE Key Function Selection	0: Disabled 1: Enabled. LO/RE key switches between LOCAL and REMOTE operation.	Default: 1 Range: 0, 1	–
o2-02 (506)	STOP Key Function Selection	0: Disabled. STOP key is disabled in REMOTE operation. 1: Enabled. STOP key is always enabled.	Default: 1 Range: 0, 1	–
o2-03 (507)	User Parameter Default Value	0: No change. 1: Set defaults. Saves parameter settings as default values for a User Initialization. 2: Clear all. Clears the default settings that have been saved for a User Initialization.	Default: 0 Range: 0 to 2	–
o2-04 (508)	Drive Model Selection	Enter the drive model. Setting required only if installing a new control board.	Default: Determined by drive capacity	–
o2-05 (509)	Frequency Reference Setting Method Selection	0: ENTER key must be pressed to enter a frequency reference. 1: ENTER key is not required. The frequency reference can be adjusted using the up and down arrow keys only.	Default: 0 Range: 0, 1	–
o2-06 (50A)	Operation Selection when Digital Operator is Disconnected	0: The drive continues operating if the digital operator is disconnected. 1: An oPr fault is triggered and the motor coasts to stop.	Default: 1 Range: 0, 1	–
o2-07 (527)	Motor Direction at Power Up when Using Operator	This parameter requires assigning drive operation to the digital operator. 0: Forward 1: Reverse	Default: 0 Range: 0, 1	–
o2-20 (81E) 	Operator RUN Save at Power Loss	When running during a power loss, the Run command is issued via the digital operator and the Run state is saved to the EEPROM. When power is restored, the Run command is automatically applied if the LOCAL/REMOTE or FREF conditions have not changed in the drive. 0: Disabled 1: Enabled	Default: 0 Range: 0, 1	–

◆ o3: Copy Function

No. (Addr. Hex)	Name	Description	Values	Page
o3-01 (515)	Copy Function Selection	0: No action 1: Read parameters from the drive, saving them onto the digital operator. 2: Copy parameters from the digital operator, writing them to the drive. 3: Verify parameter settings on the drive to check if they match the data saved on the operator.	Default: 0 Range: 0 to 3	–
o3-02 (516)	Copy Allowed Selection	0: Read operation prohibited 1: Read operation allowed	Default: 0 Range: 0, 1	–

◆ o4: Maintenance Monitor Settings

No. (Addr. Hex)	Name	Description	Values	Page
o4-01 (50B)	Cumulative Operation Time Setting	Sets the value for the cumulative operation time of the drive in units of 10 h.	Default: 0 Min.: 0 Max.: 9999	–
o4-02 (50C)	Cumulative Operation Time Selection	0: Logs power-on time 1: Logs operation time when the drive output is active (output operation time).	Default: 0 Range: 0, 1	–
o4-03 (50E)	Cooling Fan Operation Time Setting	Sets the value of the fan operation time monitor U4-03 in units of 10 h.	Default: 0 Min.: 0 Max.: 9999	–
o4-05 (51D)	Capacitor Maintenance Setting	Sets the value of the Maintenance Monitor for the capacitors. See U4-05 to check when the capacitors may need to be replaced.	Default: 0% Min.: 0 Max.: 150	–
o4-07 (523)	DC Bus Pre-Charge Relay Maintenance Setting	Sets the value of the Maintenance Monitor for the soft charge bypass relay. See U4-06 to check when the bypass relay may need to be replaced.	Default: 0% Min.: 0 Max.: 150	–
o4-09 (525)	IGBT Maintenance Setting	Sets the value of the Maintenance Monitor for the IGBTs. See U4-07 for IGBT replacement times.	Default: 0% Min.: 0 Max.: 150	–
o4-11 (510)	U2, U3 Initialization	0: U2-□□ and U3-□□ monitor data is not reset when the drive is initialized (A1-03). 1: U2-□□ and U3-□□ monitor data is reset when the drive is initialized (A1-03).	Default: 0 Range: 0, 1	–
o4-12 (512)	kWh Monitor Initialization	0: U4-10 and U4-11 monitor data is not reset when the drive is initialized (A1-03). 1: U4-10 and U4-11 monitor data is reset when the drive is initialized (A1-03).	Default: 0 Range: 0, 1	–
o4-13 (528)	Number of Run Commands Counter Initialization	0: Number of Run commands counter is not reset when the drive is initialized (A1-03). 1: Number of Run commands counter is reset when the drive is initialized (A1-03).	Default: 0 Range: 0, 1	–
o4-17 (3100)	Set/Reset Real-Time Clock	Sets the current date and time for the Real-Time Clock. 0: -- 1: Set 2: Reset	Default: 0 Range: 0 to 2	78
o4-20 (81F)	Time Display Format	Sets the time display format. 0: 12-hour 1: 24-hour	Default: 0 Range: 0, 1	–

B.10 S: Special Application

◆ S1: Dynamic Noise Control Function

No. (Addr. Hex)	Name	Description	Values	Page
S1-01 (3200)	Dynamic Audible Noise Control Function Selection Dyn Noise Ctrl	0: Disabled 0: Disabled 1: Enabled 1: Enabled	Default: 1 Range: 0, 1	–
S1-02 (3201)	Voltage Reduction Rate Volt Reduce Amt	Sets the rate at which the output voltage will be reduced as a percentage of the V/f pattern when operating with no load.	Default: 50.0% Min.: 50.0 Max.: 100.0	–
S1-03 (3202)	Voltage Restoration Level V Reduce On Lvl	Sets the level when the drive should start restoring the voltage as a percentage of the drive rated torque.	Default: 20.0% Min.: 0.0 Max.: 90.0	–
S1-04 (3203)	Voltage Restoration Complete Level V Reduce Off Lvl	Sets the level at which voltage restoration for the V/f pattern is complete as a percentage of the drive rated torque. If the output torque rises above the value of S1-04, then the voltage will be controlled in a manner specified by the V/f pattern setting.	Default: 50.0% Min.: S1-03 + 10.0 Max.: 100.0	–
S1-05 (3204)	Voltage Restoration Sensitivity Time Constant Sensitivity Time	Sets the level of sensitivity of the output torque and LPF time constants for the voltage reduction rate. The level of sensitivity can be adjusted in accordance with the load response.	Default: 1.000 s Min.: 0.000 Max.: 3.000	–
S1-06 (3205)	Voltage Restoration Time Constant at Impact Impact Load Time	Sets the voltage restoration time constant if an impact load is added.	Default: 0.050 s Min.: 0.000 Max.: 1.000	–
S1-07 (323C)	Output Phase Loss Level for Dynamic Noise Control DNC Outp Ph Loss	Reduces the output phase loss level when Dynamic Noise Control is active.	Default: 100.0% Min.: 10.0 Max.: 100.0	–

◆ S2: Programmable Run Timers

No. (Addr. Hex)	Name	Description	Values	Page
S2-01 (3206)	Sequence Timer 1 Start Time Tmr 1 Start Time	Sets the start time for timer 1. The value must be set less than or equal to S2-02.	Default: 00:00 Min.: 00:00 Max.: 24:00 </>	–
S2-02 (3207)	Sequence Timer 1 Stop Time Tmr 1 Stop Time	Sets the stop time for timer 1. The value must be set greater than or equal to S2-01.	Default: 00:00 Min.: 00:00 Max.: 24:00 </>	–
S2-03 (3208)	Sequence Timer 1 Day Selection Tmr 1 Day Sel	Sets the days for which sequence timer 1 is active. 0: Timer disabled 0: Timer disabled 1: Daily 1: Daily 2: Mon - Fri 2: Mon - Fri 3: Sat - Sun 3: Sat - Sun 4: Monday 4: Monday 5: Tuesday 5: Tuesday 6: Wednesday 6: Wednesday 7: Thursday 7: Thursday 8: Friday 8: Friday 9: Saturday 9: Saturday 10: Sunday 10: Sunday	Default: 0 Range: 0 to 10	–
S2-04 (3209)	Sequence Timer 1 Selection Tmr 1 Seq Sel	Sets the action that occurs when sequence timers 1 is active. 0: Digital output only 0: Digital out only 1: Run 1: Run 2: Run - PI disable 2: Run - PI Disable	Default: 0 Range: 0 to 2	–

No. (Addr. Hex)	Name	Description	Values	Page
S2-05 (320A)	Sequence Timer 1 Reference Source Tmr 1 Ref.Source	Selects the frequency reference source used for running the drive when sequence timer 1 is active (only applicable when S2-04 is set to 1 or 2). 0: Operator (d1-01) 0: Operator (d1-01) 1: Operator (d1-02) 1: Operator (d1-02) 2: Operator (d1-03) 2: Operator (d1-03) 3: Operator (d1-04) 3: Operator (d1-04) 4: Terminals 4: Terminals 5: Serial communication 5: Serial com 6: Option card 6: Option PCB 7: Pulse input	Default: 0 Range: 0 to 7	-
S2-06 (320B)	Sequence Timer 2 Start Time Tmr 2 Start Time	Sets the start time for timer 2. The value must be set less than or equal to S2-07.	Default: 00:00 Min.: 00:00 Max.: 24:00 </>	-
S2-07 (320C)	Sequence Timer 2 Stop Time Tmr 2 Stop Time	Sets the stop time for timer 2. The value must be set greater than or equal to S2-06.	Default: 00:00 Min.: 00:00 Max.: 24:00 </>	-
S2-08 (320D)	Sequence Timer 2 Day Selection Tmr 2 Day Sel	Sets the days for which sequence timer 2 is active. 0: Timer disabled 0: Timer disabled 1: Daily 1: Daily 2: Mon - Fri 2: Mon - Fri 3: Sat - Sun 3: Sat - Sun 4: Monday 4: Monday 5: Tuesday 5: Tuesday 6: Wednesday 6: Wednesday 7: Thursday 7: Thursday 8: Friday 8: Friday 9: Saturday 9: Saturday 10: Sunday 10: Sunday	Default: 0 Range: 0 to 10	-
S2-09 (320E)	Sequence Timer 2 Selection Tmr 2 Seq Sel	Sets the action that occurs when sequence timer 2 is active. 0: Digital output only 0: Digital out only 1: Run 1: Run 2: Run - PI disable 2: Run - PI Disable	Default: 0 Range: 0 to 2	-
S2-10 (320F)	Sequence Timer 2 Reference Source Tmr 2 Ref.Source	Selects the frequency reference source used for running the drive when sequence timer 2 is active (only applicable when S2-09 is set to 1 or 2). 0: Operator (d1-01) 0: Operator (d1-01) 1: Operator (d1-02) 1: Operator (d1-02) 2: Operator (d1-03) 2: Operator (d1-03) 3: Operator (d1-04) 3: Operator (d1-04) 4: Terminals 4: Terminals 5: Serial communication 5: Serial com 6: Option card 6: Option PCB 7: Pulse input	Default: 0 Range: 0 to 7	-
S2-11 (3210)	Sequence Timer 3 Start Time Tmr 3 Start Time	Sets the start time for timer 3. The value must be set less than or equal to S2-12.	Default: 00:00 Min.: 00:00 Max.: 24:00 </>	-
S2-12 (3211)	Sequence Timer 3 Stop Time Tmr 3 Stop Time	Sets the stop time for timer 3. The value must be set greater than or equal to S2-11.	Default: 00:00 Min.: 00:00 Max.: 24:00 </>	-
S2-13 (3212)	Sequence Timer 3 Day Selection Tmr 3 Day Sel	Sets the days for which sequence timer 3 is active. 0: Timer disabled 0: Timer disabled 1: Daily 1: Daily 2: Mon - Fri 2: Mon - Fri 3: Sat - Sun 3: Sat - Sun 4: Monday 4: Monday 5: Tuesday 5: Tuesday 6: Wednesday 6: Wednesday 7: Thursday 7: Thursday 8: Friday 8: Friday 9: Saturday 9: Saturday 10: Sunday 10: Sunday	Default: 0 Range: 0 to 10	-

B.10 S: Special Application







No. (Addr. Hex)	Name	Description	Values	Page
S2-14 (3213)	Sequence Timer 3 Selection Tmr 3 Seq Sel	Sets the action that occurs when sequence timer 3 is active. 0: Digital output only 0: Digital out only 1: Run 1: Run 2: Run - PI disable 2: Run - PI Disable	Default: 0 Range: 0 to 2	–
S2-15 (3214)	Sequence Timer 3 Reference Source Tmr 3 Ref Source	Selects the frequency reference source used for running the drive when sequence timer 3 is active (only applicable when S2-14 is set to 1 or 2). 0: Operator (d1-01) 0: Operator (d1-01) 1: Operator (d1-02) 1: Operator (d1-02) 2: Operator (d1-03) 2: Operator (d1-03) 3: Operator (d1-04) 3: Operator (d1-04) 4: Terminals 4: Terminals 5: Serial communication 5: Serial com 6: Option card 6: Option PCB 7: Pulse input	Default: 0 Range: 0 to 7	–
S2-16 (3215)	Sequence Timer 4 Start Time Tmr 4 Start Time	Sets the start time for timer 4. The value must be set less than or equal to S2-17.	Default: 00:00 Min.: 00:00 Max.: 24:00 <1>	–
S2-17 (3216)	Sequence Timer 4 Stop Time Tmr 4 Stop Time	Sets the stop time for timer 4. The value must be set greater than or equal to S2-16.	Default: 00:00 Min.: 00:00 Max.: 24:00 <1>	–
S2-18 (3217)	Sequence Timer 4 Day Selection Tmr 4 Day Sel	Sets the days for which sequence timer 4 is active. 0: Timer disabled 0: Timer disabled 1: Daily 1: Daily 2: Mon - Fri 2: Mon - Fri 3: Sat - Sun 3: Sat - Sun 4: Monday 4: Monday 5: Tuesday 5: Tuesday 6: Wednesday 6: Wednesday 7: Thursday 7: Thursday 8: Friday 8: Friday 9: Saturday 9: Saturday 10: Sunday 10: Sunday	Default: 0 Range: 0 to 10	–
S2-19 (3218)	Sequence Timer 4 Selection Tmr 4 Seq Sel	Sets the action that occurs when sequence timer 4 is active. 0: Digital output only 0: Digital out only 1: Run 1: Run 2: Run - PI disable 2: Run - PI Disable	Default: 0 Range: 0 to 2	–
S2-20 (3219)	Sequence Timer 4 Reference Source Tmr 4 Ref Source	Selects the frequency reference source used for running the drive when sequence timer 4 is active (only applicable when S2-19 is set to 1 or 2). 0: Operator (d1-01) 0: Operator (d1-01) 1: Operator (d1-02) 1: Operator (d1-02) 2: Operator (d1-03) 2: Operator (d1-03) 3: Operator (d1-04) 3: Operator (d1-04) 4: Terminals 4: Terminals 5: Serial communication 5: Serial com 6: Option card 6: Option PCB 7: Pulse input	Default: 0 Range: 0 to 7	–

<1> Setting the sequence timer start time to a higher value than the sequence timer stop time disables that sequence timer.

◆ S3: Secondary PI (PI2) Control

No. (Addr. Hex)	Name	Description	Values	Page
S3-01 (321A) 	Secondary PI Enable Selection PI2 Enable Sel	Determines when the secondary PI controller is enabled. 0: Disabled 0: Disabled 1: Always 1: Always 2: Drive running 2: Drive running 3: Motor running 3: Motor running Note: Setting 3 does not run the motor at zero speed, baseblock, or in DC injection.	Default: 0 Range: 0 to 3	–
S3-02 (321B) 	Secondary PI User Display PI2 UsrDspMaxVal	Sets the scale value of 100% PI input.	Default: 10000 Min.: 0 Max.: 60000	–
S3-03 (321C) 	Secondary PI Display Digits PI2 UsrDspDigits	Sets the decimal place display for secondary PI units. 0: No decimal places 0: No Dec (XXXXX) 1: One decimal place 1: 1 Dec (XXXX.X) 2: Two decimal places 2: 2 Dec (XXX.XX) 3: Three decimal places 3: 3 Dec (XX.XXX)	Default: 2 Range: 0 to 3	–
S3-04 (321D) 	Secondary PI Unit Selection PI2 Unit Sel	Sets the units for the secondary PI control function. 0: Inch of water (WC) 0: WC 1: Pounds per square inch (PSI) 1: PSI 2: Gallons per minute (GPM) 2: GPM 3: Degrees Fahrenheit (F) 3: °F 4: Cubic feet per minute (CFM) 4: CFM 5: Cubic meters per hour (CMH) 5: CMH 6: Liters per hour (LPH) 6: LPH 7: Liters per second (LPS) 7: LPS 8: Bar (Bar) 8: Bar 9: Pascals (Pa) 9: Pa 10: Degrees Celsius (C) 10: °C 11: Meters (Mtr) (Ft: Feet) 11: Mtr 12: Liters per minute (LPM) 12: LPM 13: Cubic meters per minute (CMM) 13: CMM 14: No unit 14: No unit 15: Percentage (%) 15: %	Default: 15 Range: 0 to 15	–
S3-05 (321E) 	Secondary PI Setpoint Value PI2 Setpoint	Sets the secondary PI controller target value.	Default: 0.00 <↔> Min.: 0.00 Max.: 600.00 <↔>	–
S3-06 (321F) 	Secondary PI Proportional Gain Setting PI2 Gain	Sets the proportional gain of the secondary PI controller. A setting of 0.00 disables P control.	Default: 1.00 Min.: 0.00 Max.: 25.00	–
S3-07 (3220) 	Secondary PI Integral Time Setting PI2 I Time	Sets the integral time for the secondary PI controller. A setting of 0.0 s disables integral control.	Default: 1.0 s Min.: 0.0 Max.: 360.0	–
S3-08 (3221) 	Secondary PI Integral Limit Setting PI2 I Limit	Sets the maximum output possible from the integrator.	Default: 100.0% Min.: 0.0 Max.: 100.0	–
S3-09 (3222) 	Secondary PI Output Upper Limit PI2 Upper Limit	Sets the maximum output possible from the secondary PI controller.	Default: 100.0% Min.: 0.0 Max.: 100.0	–
S3-10 (3223) 	Secondary PI Output Lower Limit PI2 Lower Lim	Sets the minimum output possible from the secondary PI controller.	Default: 0.00% Min.: -100.00 Max.: 100.00	–
S3-11 (3224) 	Secondary PI Output Level Selection PI2 Out Lvl Sel	Sets the secondary PI controller output direction. 0: Normal Output 0: Normal Character (direct acting) 1: Reverse Output 1: Rev Character (reverse acting)	Default: 0 Range: 0, 1	–

B.10 S: Special Application

No. (Addr. Hex)	Name	Description	Values	Page
S3-12 (3225) 	Secondary PI Disable Mode PI2 Disable Mode	Selects the secondary PI controller output when disabled. 0: No output (0%) 0: No output 1: Lower Limit (S3-10) 1: Lower Limit (S3-10) 2: Setpoint 2: Setpoint	Default: 0 Range: 0 to 2	–
S3-13 (3226) 	Secondary PI Low Feedback Detection Level PI2 Low FB Lvl	Sets the secondary PI low feedback detection level.	Default: 0.00 <1> Min.: 0.00 Max.: 600.00 <2>	–
S3-14 (3227) 	Secondary PI Low Feedback Detection Time PI2 Low FB Time	Sets the secondary PI low feedback detection delay time in seconds.	Default: 1.0 s Min.: 0.0 Max.: 25.5	–
S3-15 (3228) 	Secondary PI High Feedback Level PI2 High FB Lvl	Sets the secondary PI high feedback detection level.	Default: 100.00 <1> Min.: 0.00 Max.: 600.00 <2>	–
S3-16 (3229) 	Secondary PI High Feedback Detection Time PI2 High FB Tim	Sets the secondary PI high feedback detection delay time in seconds.	Default: 1.0 s Min.: 0.0 Max.: 25.5	–
S3-17 (322A) 	Secondary PI Feedback Detection Selection PI2 FB Det Sel	Selects when secondary PI controller low and high feedback detection are active. 0: Secondary PI enabled 0: PI2 Enabled 1: Always 1: Always	Default: 0 Range: 0, 1	–

<1> Unit is determined by S3-04.

<2> Upper limit is S3-02, decimal placeholder is determined by S3-03.

◆ S6: P1000 Protection

No. (Addr. Hex)	Name	Description	Values	Page
S6-01 (3236)	Emergency Override Speed E Override Speed	Sets the speed command used in emergency override mode when S6-02 = 0.	Default: 0.00 Hz Min.: 0.00 Max.: 240.00	–
S6-02 (3237)	Emergency Override Reference Selection E OverrideRefSel	Selects the emergency override speed source. 0: Use S6-01 Reference 0: Use S6-01 Ref 1: Use Frequency Reference 1: Use Freq Ref	Default: 0 Range: 0, 1	–
S6-07 (323C)	Output Phase Loss Level for Dynamic Noise Control DNC Outp Ph Loss	Reduces the output phase loss level when Dynamic Noise Control is active.	Default: 100.0% Min.: 10.0 Max.: 100.0	–

B.11 T: Motor Tuning

Enter data into the following parameters to tune the motor and drive for optimal performance.

◆ T1: Induction Motor Auto-Tuning

No. (Addr. Hex)	Name	Description	Values	Page
T1-01 (701)	Auto-Tuning Mode Selection	2: Stationary Auto-Tuning for Line-to-Line Resistance 3: Rotational Auto-Tuning for V/f Control (necessary for Energy Savings and Speed Estimation Speed Search)	Default: 2 Range: 2, 3	–
T1-02 (702)	Motor Rated Power	Sets the motor rated power as specified on the motor nameplate. Note: Use the following formula to convert horsepower into kilowatts: 1HP = 0.746 kW.	Default: <1> Min.: 0.00 kW Max.: 650.00 kW	–
T1-03 (703)	Motor Rated Voltage	Sets the motor rated voltage as specified on the motor nameplate.	Default: 200.0 V <2> Min: 0.0 Max: 255.0 <2>	–
T1-04 (704)	Motor Rated Current	Sets the motor rated current as specified on the motor nameplate.	Default: <1> Min.: 10% of drive rated current Max.: 200% of drive rated current	–
T1-05 (705)	Motor Base Frequency	Sets the rated frequency of the motor as specified on the motor nameplate.	Default: 60.0 Hz Min.: 0.0 Max.: 400.0	–
T1-06 (706)	Number of Motor Poles	Sets the number of motor poles as specified on the motor nameplate.	Default: 4 Min.: 2 Max.: 48	–
T1-07 (707)	Motor Base Speed	Sets the rated speed of the motor as specified on the motor nameplate.	Default: 1750 r/min Min.: 0 Max.: 24000	–
T1-11 (70B)	Motor Iron Loss	Sets the iron loss for determining the Energy Saving coefficient. The value is set to E2-10 (motor iron loss) set when the power is cycled. If T1-02 is changed, a default value appropriate for the motor capacity that was entered will appear.	Default: 14 W <3> Min.: 0 Max.: 65535	–

<1> Default setting is dependent on parameter o2-04, Drive Model Selection.

<2> Values shown are specific to 200 V class drives. Double the value for 400 V class drives. Multiply the value by 2.875 for 600 V class drives.

<3> Default setting value differs depending on the motor code value and motor parameter settings.

B.12 U: Monitors

Monitor parameters allow the user to view drive status, fault information, and other data concerning drive operation.

◆ U1: Operation Status Monitors

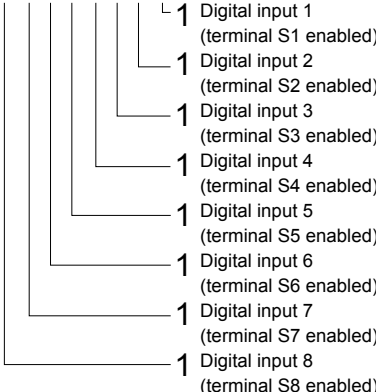
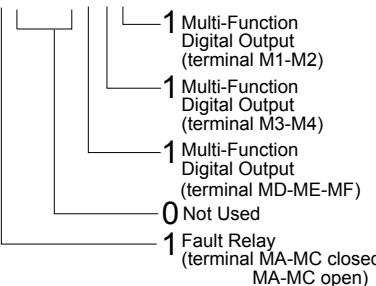
No. (Addr. Hex)	Name	Description	Analog Output Level	Unit
U1-01 (40)	Frequency Reference	Monitors the frequency reference. Display units are determined by o1-03.	10 V: Max frequency	0.01 Hz
U1-02 (41)	Output Frequency	Displays the output frequency. Display units are determined by o1-03.	10 V: Max frequency	0.01 Hz
U1-03 (42)	Output Current	Displays the output current.	10 V: Drive rated current	< / > < / >
U1-04 (43)	Control Method	0: V/f Control	No signal output available	-
U1-06 (45)	Output Voltage Reference	Displays the output voltage.	10 V: 200 Vrms < / >	0.1 Vac
U1-07 (46)	DC Bus Voltage	Displays the DC bus voltage.	10 V: 400 V < / >	1 Vdc
U1-08 (47)	Output Power	Displays the output power (this value is calculated internally).	10 V: Drive capacity (motor capacity) kW	< / >
U1-10 (49)	Input Terminal Status	Displays the input terminal status. U1 - 10 = 00000000 	No signal output available	-
U1-11 (4A)	Output Terminal Status	Displays the output terminal status. U1 - 11 = 00000000 	No signal output available	-

No. (Addr. Hex)	Name	Description	Analog Output Level	Unit
U1-12 (4B)	Drive Status	Verifies the drive operation status. U1 - 12=00000000 	No signal output available	–
U1-13 (4E)	Terminal A1 Input Level	Displays the signal level to analog input terminal A1.	10 V: 100%	0.1%
U1-14 (4F)	Terminal A2 Input Level	Displays the signal level to analog input terminal A2.	10 V: 100%	0.1%
U1-15 (50)	Terminal A3 Input Level	Displays the signal level to analog input terminal A3.	10 V: 100%	0.1%
U1-16 (53)	Output Frequency after Soft Starter	Displays output frequency with ramp time and S-curves. Units determined by o1-03.	10 V: Max frequency	0.01 Hz
U1-18 (61)	oPE Fault Parameter	Displays the parameter number that caused the oPE02 operation error.	No signal output available	–
U1-19 (66)	MEMOBUS/Modbus Error Code	Displays the contents of a MEMOBUS/Modbus error. U1 - 19=00000000 	No signal output available	–
U1-24 (7D)	Input Pulse Monitor	Displays the frequency to pulse train input terminal RP.	Determined by H6-02	1 Hz
U1-25 (4D)	Software Number (Flash)	FLASH ID	No signal output available	–
U1-26 (5B)	Software No. (ROM)	ROM ID	No signal output available	–
U1-29 (7AA)	Software No. (PWM)	PWM ID	No signal output available	–
U1-75 (851)	Time-Hour/Minute	Displays the current time (Hours and Minutes).	No signal output available	–
U1-76 (852)	Date – Year	Displays the current year.	No signal output available	–
U1-77 (853)	Date – Month/Day	Displays the current date (Month and Date).	No signal output available	–
U1-78 (854)	Date – Week Day	Displays the current date of the week. 0: Sunday 1: Monday 2: Tuesday 3: Wednesday 4: Thursday 5: Friday 6: Saturday	No signal output available	–

<1> The number of decimal places in the parameter value depends on the drive model and the ND selection. This value has two decimal places (0.01 A) if the drive is set for a maximum applicable motor capacity up to and including 11 kW, and one decimal place (0.1 A) if the maximum applicable motor capacity is higher than 11 kW.

<2> When reading the value of this monitor via MEMOBUS/Modbus, a value of 8192 is equal to 100% of the drive rated output current.

B.12 U: Monitors

- <3> Values shown are specific to 200 V class drives. Double the value for 400 V class drives. Multiply the value by 2.875 for 600 V class drives.
- <4> The display resolution depends on the ND selection. This value has two decimal places (0.01 kW) if the drive is set for a maximum applicable motor capacity up to and including 11 kW, and one decimal place (0.1 kW) if the maximum applicable motor capacity is higher than 11 kW.

◆ U2: Fault Trace

No. (Addr. Hex)	Name	Description	Analog Output Level	Unit
U2-01 (80)	Current Fault	Displays the current fault.	No signal output available	–
U2-02 (81)	Previous Fault	Displays the previous fault.	No signal output available	–
U2-03 (82)	Frequency Reference at Previous Fault	Displays the frequency reference at the previous fault.	No signal output available	0.01 Hz
U2-04 (83)	Output Frequency at Previous Fault	Displays the output frequency at the previous fault.	No signal output available	0.01 Hz
U2-05 (84)	Output Current at Previous Fault	Displays the output current at the previous fault.	No signal output available	</> </>
U2-07 (86)	Output Voltage at Previous Fault	Displays the output voltage at the previous fault.	No signal output available	0.1 Vac
U2-08 (87)	DC Bus Voltage at Previous Fault	Displays the DC bus voltage at the previous fault.	No signal output available	1 Vdc
U2-09 (88)	Output Power at Previous Fault	Displays the output power at the previous fault.	No signal output available	0.1 kW
U2-11 (8A)	Input Terminal Status at Previous Fault	Displays the input terminal status at the previous fault. Displayed as in U1-10.	No signal output available	–
U2-12 (8B)	Output Terminal Status at Previous Fault	Displays the output status at the previous fault. Displays the same status displayed in U1-11.	No signal output available	–
U2-13 (8C)	Drive Operation Status at Previous Fault	Displays the operation status of the drive at the previous fault. Displays the same status displayed in U1-12.	No signal output available	–
U2-14 (8D)	Cumulative Operation Time at Previous Fault	Displays the cumulative operation time at the previous fault.	No signal output available	1 h
U2-15 (7E0)	Soft Starter Speed Reference at Previous Fault	Displays the speed reference for the soft starter at the previous fault.	No signal output available	0.01 Hz
U2-20 (8E)	Heatsink Temperature at Previous Fault	Displays the temperature of the heatsink when the most recent fault occurred.	No signal output available	1 °C
U2-27 (7FA)	Motor Temperature at Previous Fault (NTC)	Displays the temperature of the motor when the most recent fault occurred.	No signal output available	1 °C
U2-30 (3008)	Date Year at Previous Fault Date Year YYYY	Displays the year when the most recent fault occurred.	No signal output available	–
U2-31 (3009)	Date Month and Day at Previous Fault Date Mo Day MMDD	Displays the date and day when the most recent fault occurred.	No signal output available	–
U2-32 (300A)	Time Hours and Minutes at Previous Fault Time Hr Min HHMM	Displays the time when the most recent fault occurred.	No signal output available	–

- <1> The number of decimal places in the parameter value depends on the drive model and the ND selection. This value has two decimal places (0.01 A) if the drive is set for a maximum applicable motor capacity up to and including 11 kW, and one decimal place (0.1 A) if the maximum applicable motor capacity is higher than 11 kW.
- <2> When reading the value of this monitor via MEMOBUS/Modbus, a value of 8192 is equal to 100% of the drive rated output current.

◆ U3: Fault History

No. (Addr. Hex)	Name	Description	Analog Output Level	Unit
U3-01 to U3-04 (90 to 93 (800 to 803))	First to 4th Most Recent Fault	Displays the first to the fourth most recent faults.	No signal output available	–
U3-05 to U3-10 (804 to 809)	5th to 10th Most Recent Fault	Displays the fifth to the tenth most recent faults. After ten faults, data for the oldest fault is deleted. The most recent fault appears in U3-01, with the next most recent fault appearing in U3-02. The data is moved to the next monitor parameter each time a fault occurs.	No signal output available	–
U3-11 to U3-14 (94 to 97 (80A to 80D))	Cumulative Operation Time at 1st to 4th Most Recent Fault	Displays the cumulative operation time when the first to the fourth most recent faults occurred.	No signal output available	1 h
U3-15 to U3-20 (80E to 813)	Cumulative Operation Time at 5th to 10th Most Recent Fault	Displays the cumulative operation time when the fifth to the tenth most recent faults occurred.	No signal output available	1 h
U3-21 (300B)	Date Year at Most Recent Fault Fault 1 YYYY	Displays the year when the most recent fault occurred.	No signal output available	–
U3-22 (300C)	Date Month and Day at Most Recent Fault Fault 1 MMDD	Displays the date and day when the most recent faults occurred.	No signal output available	–
U3-23 (300D)	Time Hours and Minutes at Most Recent Fault Fault 1 HHMM	Displays the time when the most recent fault occurred.	No signal output available	–
U3-24 (300E)	Date Year at 2nd Most Recent Fault Fault 2 YYYY	Displays the year when the second most recent fault occurred.	No signal output available	–
U3-25 (300F)	Date Month and Day at 2nd Most Recent Fault Fault 2 MMDD	Displays the date and day when the second most recent fault occurred.	No signal output available	–
U3-26 (3010)	Time Hours and Minutes at 2nd Most Recent Fault Fault 2 HHMM	Displays the time when the second most recent fault occurred.	No signal output available	–
U3-27 (3011)	Date Year at 3rd Most Recent Fault Fault 3 YYYY	Displays the year when the most third recent fault occurred.	No signal output available	–
U3-28 (3012)	Date Month and Day at 3rd Most Recent Fault Fault 3 MMDD	Displays the date and day when the third most recent fault occurred.	No signal output available	–
U3-29 (3013)	Time Hours and Minutes at 3rd Most Recent Fault Fault 3 HHMM	Displays the time when the third most recent fault occurred.	No signal output available	–
U3-30 (3014)	Date Year at 4th Most Recent Fault Fault 4 YYYY	Displays the year when the fourth most recent fault occurred.	No signal output available	–
U3-31 (3015)	Date Month and Day at 4th Most Recent Fault Fault 4 MMDD	Displays the date and day when the fourth most recent fault occurred.	No signal output available	–
U3-32 (3016)	Time Hours and Minutes at 4th Most Recent Fault Fault 4 HHMM	Displays the time when the fourth most recent fault occurred.	No signal output available	–
U3-33 (3017)	Date Year at 5th Most Recent Fault Fault 5 YYYY	Displays the year when the fifth most recent fault occurred.	No signal output available	–
U3-34 (3018)	Date Month and Day at 5th Most Recent Fault Fault 5 MMDD	Displays the date and day when the fifth most recent fault occurred.	No signal output available	–

B.12 U: Monitors

No. (Addr. Hex)	Name	Description	Analog Output Level	Unit
U3-35 (3019)	Time Hours and Minutes at 5th Most Recent Fault Fault 5 HHMM	Displays the time when the fifth most recent fault occurred.	No signal output available	–
U3-36 (301A)	Date Year at 6th Most Recent Fault Fault 6 YYYY	Displays the year when the sixth most recent fault occurred.	No signal output available	–
U3-37 (301B)	Date Month and Day at 6th Most Recent Fault Fault 6 MMDD	Displays the date and day when the sixth most recent fault occurred.	No signal output available	–
U3-38 (301C)	Time Hours and Minutes at 6th Most Recent Fault Fault 6 HHMM	Displays the time when the most sixth recent fault occurred.	No signal output available	–
U3-39 (301D)	Date Year at 7th Most Recent Fault Fault 7 YYYY	Displays the year when the most seventh recent fault occurred.	No signal output available	–
U3-40 (301E)	Date Month and Day at 7th Most Recent Fault Fault 7 MMDD	Displays the date and day when the seventh most recent fault occurred.	No signal output available	–
U3-41 (301F)	Time Hours and Minutes at 7th Most Recent Fault Fault 7 HHMM	Displays the time when the seventh most recent fault occurred.	No signal output available	–
U3-42 (3020)	Date Year at 8th Most Recent Fault Fault 8 YYYY	Displays the year when the eighth most recent fault occurred.	No signal output available	–
U3-43 (3021)	Date Month and Day 8th at Most Recent Fault Fault 8 MMDD	Displays the date and day when the eighth most recent fault occurred.	No signal output available	–
U3-44 (3022)	Time Hours and Minutes at 8th Most Recent Fault Fault 8 HHMM	Displays the time when the eighth most recent fault occurred.	No signal output available	–
U3-45 (3023)	Date Year at 9th Most Recent Fault Fault 9 YYYY	Displays the year when the ninth most recent fault occurred.	No signal output available	–
U3-46 (3024)	Date Month and Day at 9th Most Recent Fault Fault 9 MMDD	Displays the date and day when the ninth most recent fault occurred.	No signal output available	–
U3-47 (3025)	Time Hours and Minutes at 9th Most Recent Fault Fault 9 HHMM	Displays the time when the ninth most recent fault occurred.	No signal output available	–
U3-48 (3026)	Date Year at 10th Most Recent Fault Fault 10 YYYY	Displays the year when the tenth most recent fault occurred.	No signal output available	–
U3-49 (3027)	Date Month and Day at 10th Most Recent Fault Fault 10 MMDD	Displays the date and day when the tenth most recent fault occurred.	No signal output available	–
U3-50 (3028)	Time Hours and Minutes at 10th Most Recent Fault 10 HHMM	Displays the time when the tenth most recent fault occurred.	No signal output available	–

◆ U4: Maintenance Monitors

No. (Addr. Hex)	Name	Description	Analog Output Level	Unit
U4-01 (4C)	Cumulative Operation Time	Displays the cumulative operation time of the drive. The value for the cumulative operation time counter can be reset in parameter o4-01. Use parameter o4-02 to determine if the operation time should start as soon as the power is switched on or only while the Run command is present. The maximum number displayed is 99999, after which the value is reset to 0.	No signal output available	1 h
U4-02 (75)	Number of Run Commands	Displays the number of times the Run command is entered. Reset the number of Run commands using parameter o4-13. This value will reset to 0 and start counting again after reaching 65535.	No signal output available	1 Time

No. (Addr. Hex)	Name	Description	Analog Output Level	Unit
U4-03 (67)	Cooling Fan Operation Time	Displays the cumulative operation time of the cooling fan. The default value for the fan operation time is reset in parameter o4-03. This value will reset to 0 and start counting again after reaching 99999.	No signal output available	1 h
U4-04 (7E)	Cooling Fan Maintenance	Displays main cooling fan usage time as a percentage of its expected performance life. Parameter o4-03 can be used to reset this monitor. Replace the fan when this monitor reaches 90%.	No signal output available	1%
U4-05 (7C)	Capacitor Maintenance	Displays main circuit capacitor usage time as a percentage of their expected performance life. Parameter o4-05 can be used to reset this monitor. Replace the capacitor when this monitor reaches 90%.	No signal output available	1%
U4-06 (7D6)	Soft Charge Bypass Relay Maintenance	Displays the soft charge bypass relay maintenance time as a percentage of its estimated performance life. Parameter o4-07 can be used to reset this monitor. Replace the soft charge bypass relay when this monitor reaches 90%.	No signal output available	1%
U4-07 (7D7)	IGBT Maintenance	Displays IGBT usage time as a percentage of the expected performance life. Parameter o4-09 can be used to reset this monitor. Replace the IGBT when this monitor reaches 90%.	No signal output available	1%
U4-08 (68)	Heatsink Temperature	Displays the heatsink temperature.	10 V: 100 °C	1 °C
U4-09 (5E)	LED Check	Lights all segments of the LED to verify that the display is working properly.	No signal output available	–
U4-10 (5C)	kWh, Lower 4 Digits	Monitors the drive output power. The value is shown as a 9-digit number displayed across two monitor parameters, U4-10 and U4-11. Example: 12345678.9 kWh is displayed as: U4-10: 678.9 kWh U4-11: 12345 MWh	No signal output available	1 kWh
U4-11 (5D)	kWh, Upper 5 Digits		No signal output available	1 MWh
U4-13 (7CF)	Peak Hold Current	Displays the highest current value that occurred during run.	No signal output available	0.01 A <I>
U4-14 (7D0)	Peak Hold Output Frequency	Displays the output frequency when the current value shown in U4-13 occurred.	No signal output available	0.01 Hz
U4-16 (7D8)	Motor Overload Estimate (oL1)	Shows the value of the motor overload detection accumulator. 100% is equal to the oL1 detection level.	10 V: 100%	0.1%
U4-18 (7DA)	Frequency Reference Source Selection	Displays the source for the frequency reference as XY-nn. X: indicates which reference is used: 1 = Reference 1 (b1-01) 2 = Reference 2 (b1-15) Y-nn: indicates the reference source 0-01 = Digital operator 1-01 = Analog (terminal A1) 1-02 = Analog (terminal A2) 1-03 = Analog (terminal A3) 2-02 to 17 = Multi-step speed (d1-02 to 17) 3-01 = MEMOBUS/Modbus communications 4-01 = Communication option card 5-01 = Pulse input	No signal output available	–
U4-19 (7DB)	Frequency Reference from MEMOBUS/Modbus Comm.	Displays the frequency reference provided by MEMOBUS/Modbus (decimal).	No signal output available	0.01%
U4-20 (7DC)	Option Frequency Reference	Displays the frequency reference input by an option card (decimal).	No signal output available	–

B.12 U: Monitors

No. (Addr. Hex)	Name	Description	Analog Output Level	Unit
U4-21 (7DD)	Run Command Source Selection	Displays the source for the Run command as XY-nn. X: Indicates which Run source is used: 1 = Reference 1 (b1-02) 2 = Reference 2 (b1-16) Y: Input power supply data 0 = Digital operator 1 = External terminals 3 = MEMOBUS/Modbus communications 4 = Communication option card nn: Run command limit status data 00: No limit status. 01: Run command was left on when stopped in the PRG mode 02: Run command was left on when switching from LOCAL to REMOTE operation 03: Waiting for soft charge bypass contactor after power up (Uv or Uv1 flashes after 10 s) 04: Waiting for "Run command prohibited" time period to end 05: Fast Stop (digital input, digital operator) 06: b1-17 (Run command given at power-up) 07: During baseblock while coast to stop with timer 08: Frequency reference is below minimal reference during baseblock 09: Waiting for Enter command	No signal output available	–
U4-22 (7DE)	MEMOBUS/Modbus Communications Reference	Displays the drive control data set by MEMOBUS/Modbus communications register no. 0001H as a four-digit hexadecimal number.	No signal output available	–
U4-23 (7DF)	Communication Option Card Reference	Displays drive control data set by an option card as a four-digit hexadecimal number.	No signal output available	–
U4-32 (7FB)	Motor Temperature (NTC)	Displays the motor temperature (NTC). U4-32 will display "20 °C" when a multi-function analog input is not set for motor thermistor input (H1-□□ = 17H).	200 °C	1 °C
U4-37 (1044)	oH Alarm Location Monitor	Displays the module where the oH alarm occurred as a binary number.	No signal output available	–
U4-38 (1045)	FAn Alarm Location Monitor	Displays the module where the FAn alarm occurred as a binary number.	No signal output available	–
U4-39 (1046)	voF Alarm Location Monitor	Displays the module where the voF alarm occurred as a binary number.	No signal output available	–

<1> When reading the value of this monitor via MEMOBUS/Modbus, a value of 8192 is equal to 100% of the drive rated output current.

◆ U5: PID Monitors

No. (Addr. Hex)	Name	Description	Analog Output Level	Unit
U5-01 (57)	PID Feedback 1	Displays the PID feedback value.	10 V: 100%	0.01% <1>
U5-02 (63)	PID Input	Displays the amount of PID input (deviation between PID setpoint and feedback).	10 V: 100%	0.01%
U5-03 (64)	PID Output	Displays PID control output.	10 V: 100%	0.01%
U5-04 (65)	PID Setpoint	Displays the PID setpoint.	10 V: 100%	0.01% <1>
U5-05 (7D2)	PID Differential Feedback	Displays the 2nd PID feedback value if differential feedback is used (H3-□□ = 16).	10 V: 100%	0.01%
U5-06 (7D3)	PID Adjusted Feedback	Displays the difference of both feedback values if differential feedback is used (U5-01 - U5-05). If differential feedback is not used, then U5-01 and U5-06 will be the same.	10 V: 100%	0.01%
U5-14 (86B)	PI Output 2 Upper 4 Digits PI Output2 U4	Displays the custom PI output. U5-14 shows the upper 4 digits while U5-15 shows the lower 4 digits. Monitors are scaled by b5-43 and b5-44	No signal output available	1 <2>
U5-15 (86C)	PI Output 2 Lower 4 Digits PI Output2 L4	Displays the custom PI output. U5-14 shows the upper 4 digits while U5-15 shows the lower 4 digits. Monitors are scaled by b5-43 and b5-44.	No signal output available	0.01 <2>

No. (Addr. Hex)	Name	Description	Analog Output Level	Unit
U5-17 (86E)	PI2 Setpoint PI2 Setpoint	Displays the secondary PI setpoint.	Dependent upon S3-02	<2>
U5-18 (86F)	PI2 Feedback PI2 Feedback	Displays the secondary PI feedback value.	Dependent upon S3-02	<2>
U5-19 (870)	PI2 Input PI2 Input	Displays the secondary PI input (deviation between PI target and feedback).	Dependent upon S3-02	<2>
U5-20 (871)	PI2 Output PI2 Output	Displays the secondary PI control output.	Dependent upon S3-02	<2>
U5-30 (3000)	Time Hr Min HHMM Time Hr Min HHMM	Displays the current time (Hours and Minutes).	No signal output available	1
U5-31 (3001)	Date Year Date Year	Displays the current year.	No signal output available	1
U5-32 (3002)	Date Mo Day MMDD Date Mo Day MMDD	Displays the current date (Month and Day).	No signal output available	1
U5-33 (3003)	Date Week 000W Date Week	Displays the current date of the week. 0: Sunday 0: Sunday 1: Monday 1: Monday 2: Tuesday 2: Tuesday 3: Wednesday 3: Wednesday 4: Thursday 4: Thursday 5: Friday 5: Friday 6: Saturday 6: Saturday	No signal output available	1
U5-99 (1599)	PID Setpoint Command PID Setpoint Cmd	Displays the PID Setpoint commanded by the source.	No signal output available	0.01% <1>

<1> Unit, range and resolution is determined by b5-20, b5-38, b5-39, and b5-46

<2> Unit is determined by b5-41

<3> Unit is determined by S3-04.

◆ U6: Operation Status Monitors

No. (Addr. Hex)	Name	Description	Analog Output Level	Unit
U6-01 (51)	Motor Secondary Current (Iq)	Displays the value of the motor secondary current (Iq). Motor rated secondary current is 100%.	10 V: Motor secondary rated current	0.1%

Note: Fault histories are not kept when CPF00, CPF01, CPF06, CPF24, oFA00, oFb00, oFC00, Uv1, Uv2, or Uv3 occur.

This Page Intentionally Blank

Appendix: C

Standards Compliance

This appendix explains the guidelines and criteria for maintaining CE and UL standards.

C.1	EUROPEAN STANDARDS.....	232
C.2	UL AND CSA STANDARDS.....	239

C.1 European Standards



Figure C.1 CE Mark

The CE mark indicates compliance with European safety and environmental regulations. It is required for engaging in business and commerce in Europe.

European standards include the Machinery Directive for machine manufacturers, the Low Voltage Directive for electronics manufacturers, and the EMC guidelines for controlling noise.

This drive displays the CE mark based on the EMC guidelines and the Low Voltage Directive.

- **Low Voltage Directive:** 2006/95/EC
- **EMC Guidelines:** 2004/108/EC

Devices used in combination with this drive must also be CE certified and display the CE mark. When using drives displaying the CE mark in combination with other devices, it is ultimately the responsibility of the user to ensure compliance with CE standards. After setting up the device, verify that conditions meet European standards.

Note: 600 V class drives (models 5□□□□□□) are not compliant with European Standards.

◆ CE Low Voltage Directive Compliance

This drive has been tested according to European standard IEC61800-5-1, and it fully complies with the Low Voltage Directive. To comply with the Low Voltage Directive, be sure to meet the following conditions when combining this drive with other devices:

■ Area of Use

Do not use drives in areas with pollution higher than severity 2 and overvoltage category 3 in accordance with IEC664.

■ Factory Recommended Branch Circuit Protection

Yaskawa recommends installing one of the following types of branch circuit protection to maintain compliance with UL508C. Semiconductor protective type fuses are preferred. Alternate branch circuit protection devices are also listed in [Table C.1](#).

NOTICE: If a fuse is blown or a Ground Fault Circuit Interrupter (GFCI) is tripped, check the wiring and the selection of peripheral devices to identify the cause. Contact Yaskawa before restarting the drive or the peripheral devices if the cause cannot be identified.

Table C.1 Factory Recommended Drive Branch Circuit Protection

Drive Model	Fuse Type	
	Manufacturer: Bussmann	
	Model	Fuse Ampere Rating (A)
Three-Phase 200 V Class		
2A0004	FWH-70B	70
2A0006	FWH-70B	70
2A0008	FWH-70B	70
2A0010	FWH-70B	70
2A0012	FWH-70B	70
2A0018	FWH-90B	90
2A0021	FWH-90B	90
2A0030	FWH-100B	100
2A0040	FWH-200B	200
2A0056	FWH-200B	200
2A0069	FWH-200B	200
2A0081	FWH-300A	300
2A0110	FWH-300A	300
2A0138	FWH-350A	350

Drive Model	Fuse Type	
	Manufacturer: Bussmann	
	Model	Fuse Ampere Rating (A)
2A0169	FWH-400A	400
2A0211	FWH-400A	400
2A0250	FWH-600A	600
2A0312	FWH-700A	700
2A0360	FWH-800A	800
2A0415	FWH-1000A	1000
Three-Phase 400 V Class		
4A0002	FWH-40B	40
4A0004	FWH-50B	50
4A0005	FWH-70B	70
4A0007	FWH-70B	70
4A0009	FWH-90B	90
4A0011	FWH-90B	90
4A0018	FWH-80B	80
4A0023	FWH-100B	100
4A0031	FWH-125B	125
4A0038	FWH-200B	200
4A0044	FWH-250A	250
4A0058	FWH-250A	250
4A0072	FWH-250A	250
4A0088	FWH-250A	250
4A0103	FWH-250A	250
4A0139	FWH-350A	350
4A0165	FWH-400A	400
4A0208	FWH-500A	500
4A0250	FWH-600A	600
4A0296	FWH-700A	700
4A0362	FWH-800A	800
4A0414	FWH-800A	800
4A0515	FWH-1000A	1000
4A0675	FWH-1200A	1200
Three-Phase 600 V Class		
5A0003 </>	FWP-50B	50
5A0004 </>	FWP-50B	50
5A0006 </>	FWP-60B	60
5A0009 </>	FWP-60B	60
5A0011 </>	FWP-70B	70
5A0017 </>	FWP-100B	100
5A0022 </>	FWP-100B	100
5A0027 </>	FWP-125A	125
5A0032 </>	FWP-125A	125
5A0041 </>	FWP-175A	175
5A0052 </>	FWP-175A	175
5A0062 </>	FWP-250A	250
5A0077 </>	FWP-250A	250
5A0099 </>	FWP-250A	250

C.1 European Standards

Drive Model	Fuse Type	
	Manufacturer: Bussmann	
	Model	Fuse Ampere Rating (A)
5A0125 </>	FWP-350A	350
5A0145 </>	FWP-350A	350
5A0192 </>	FWP-600A	600
5A0242 </>	FWP-600A	600

<1> 600 V class drives are not compliant with European Standards.

■ Guarding Against Harmful Materials

When installing IP00/Open Type enclosure drives, use an enclosure that prevents foreign material from entering the drive from above or below.

■ Grounding

The drive is designed to be used in T-N (grounded neutral point) networks. If installing the drive in other types of grounded systems, contact your Yaskawa representative for instructions.

◆ EMC Guidelines Compliance

This drive is tested according to European standards EN61800-3: 2004.

■ EMC Filter Installation

The following conditions must be met to ensure continued compliance with guidelines. [Refer to EMC Filters on page 237](#) for EMC filter selection.

Installation Method

Verify the following installation conditions to ensure that other devices and machinery used in combination with this drive also comply with EMC guidelines.

1. Install an EMC noise filter to the input side specified by Yaskawa for compliance with European standards.
2. Place the drive and EMC noise filter in the same enclosure.
3. Use braided shield cable for the drive and motor wiring, or run the wiring through a metal conduit.
4. Keep wiring as short as possible. Ground the shield on both the drive side and the motor side.

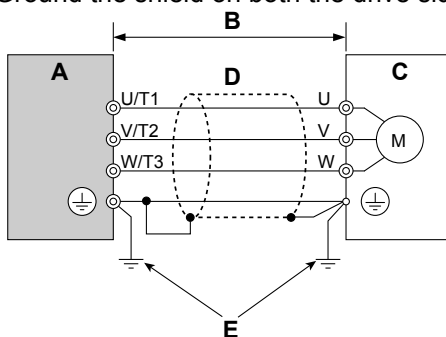

- A – Drive
 B – 10 m max cable length between drive and motor
 C – Motor
 D – Metal conduit
 E – Ground wire should be as short as possible.

Figure C.2 Installation Method

5. Make sure the protective earthing conductor complies with technical standards and local safety regulations.

WARNING! Electrical Shock Hazard. Because the leakage current exceeds 3.5 mA in models 4A0414 to 4A1200, IEC 61800-5-1 states that either the power supply must be automatically disconnected in case of discontinuity of the protective earthing conductor, or a protective earthing conductor with a cross-section of at least 10 mm² (Cu) or 16 mm² (Al) must be used. Failure to comply may result in death or serious injury.

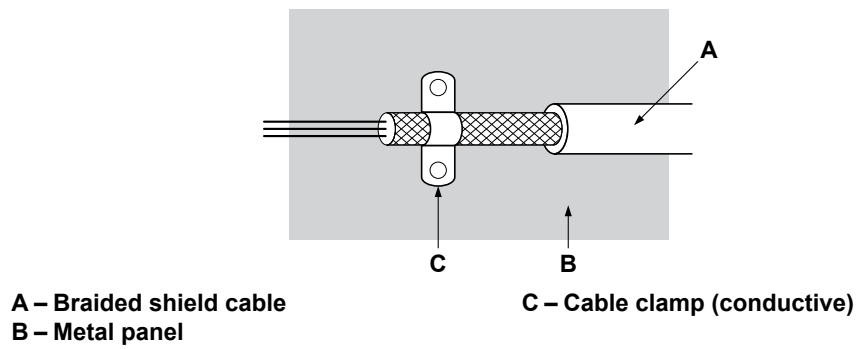
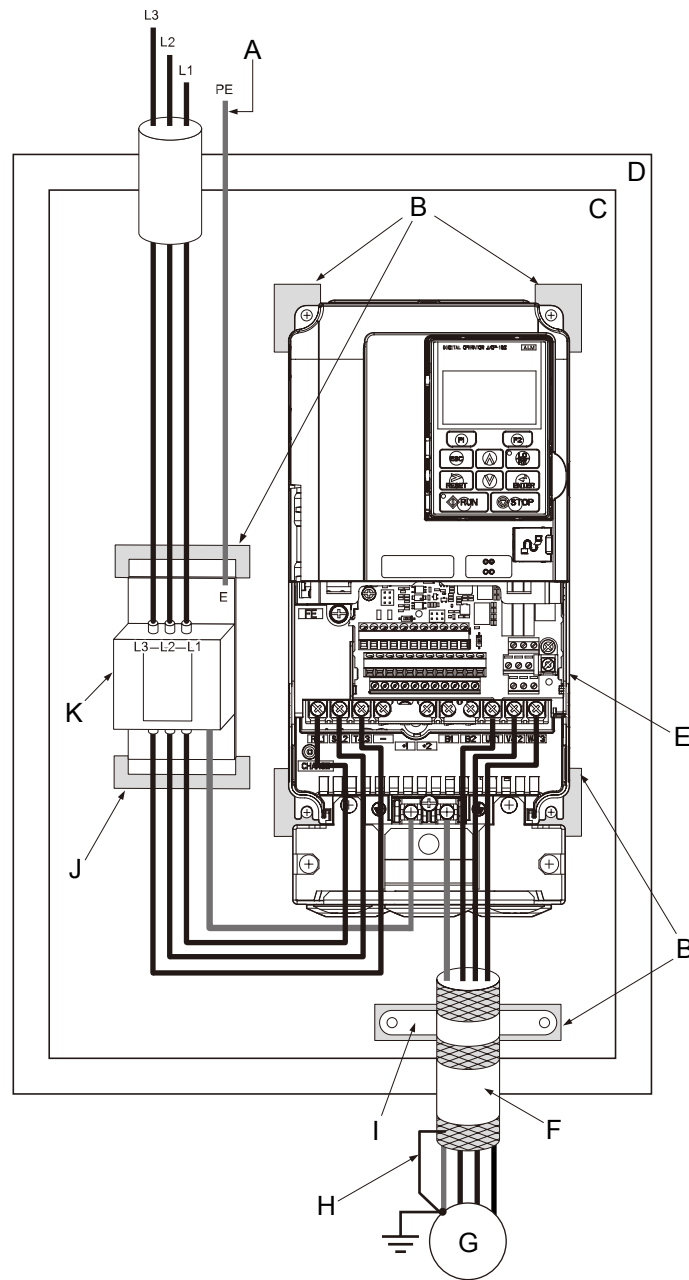

Figure C.3 Ground Area

6. Connect a DC link choke to minimize harmonic distortion. [Refer to DC Link Chokes for EN 61000-3-2 Compliance on page 238.](#)

C.1 European Standards

Three-Phase 200 V / 400 V Class



- A – Make sure the ground wire is grounded
- B – Grounding surface (remove any paint or sealant)
- C – Metal plate
- D – Enclosure panel
- E – Drive
- F – Motor cable (braided shield cable, max. 10 m)
- G – Motor
- H – Cable shield ground
- I – Cable clamp
- J – Ground plate (scrape off any visible paint)
- K – EMC noise filter

Figure C.4 EMC Filter and Drive Installation for CE Compliance (Three-Phase 200 V / 400 V Class)

■ EMC Filters

Install the drive with the EMC filters listed in [Table C.2](#) to comply with the EN61800-3 requirements.

Table C.2 EN61800-3 Filters

Drive Model	Filter Data (Manufacturer: Schaffner)					Figure	
	Type	Rated Current (A)	Weight (lb)	Dimensions [W x D x H] (in)	Y x X (in)		
Three-Phase 200 V Class							
2A0004	FS5972-10-07	10	2.6	5.6 × 1.8 × 13.0	4.5 × 12.3	1	
2A0006							
2A0008							
2A0010	FS5972-18-07	18	2.9	5.6 × 1.8 × 13.0	4.5 × 12.3		
2A0012							
2A0018							
2A0021	FS5972-35-07	35	4.6	8.1 × 2.0 × 14.0	6.9 × 13.2		
2A0030							
2A0040							
2A0056	FS5972-60-07	60	8.8	9.3 × 2.6 × 16.1	8.1 × 15.4		
2A0069							
2A0081							
2A0110	FS5972-100-35	100	7.5	3.5 × 5.9 × 13.0	2.6 × 10.0	2	
2A0138							
2A0169							
2A0211	FS5972-170-40	170	13.2	4.7 × 6.7 × 17.8	4.0 × 14.4		
2A0250							
2A0312							
2A0360	FS5972-250-37	250	25.8	5.1 × 9.5 × 24.0	3.5 × 19.6		
2A0415							
2A0415							
2A0250	FS5972-410-99	410	23.1	10.2 × 4.5 × 15.2	9.3 × 4.7	3	
2A0312							
2A0360							
2A0415	FS5972-600-99	600	24.3	10.2 × 5.3 × 15.2	9.3 × 4.7		
2A0415							
2A0415							
Three-Phase 400 V Class							
4A0002	FS5972-10-07	10	2.7	5.6 × 1.8 × 13.0	4.5 × 12.3		1
4A0004							
4A0005							
4A0007							
4A0009	FS5972-18-07	18	2.9	5.6 × 1.8 × 13.0	4.5 × 12.3		
4A0011							
4A0018							
4A0023	FS5972-35-07	35	4.6	8.1 × 2.0 × 14.0	6.9 × 13.2		
4A0031							
4A0038							
4A0044	FS5972-60-07	60	8.8	9.3 × 2.6 × 16.1	8.0 × 15.4		
4A0058							
4A0072							
4A0088	FS5972-100-35	100	16.5	3.5 × 5.9 × 13.0	2.6 × 10.0	2	
4A0103							
4A0139							
4A0165	FS5972-170-35	170	10.4	4.7 × 6.7 × 17.8	4.0 × 14.4		
4A0208							
4A0250							
4A0296	FS5972-250-37	250	25.8	5.1 × 9.5 × 24.0	3.5 × 19.6		
4A0362							
4A0414							
4A0515	FS5972-410-99	410	23.1	10.2 × 4.5 × 15.2	9.3 × 4.7	3	
4A0675							
4A0675							
4A0675	FS5972-600-99	600	24.3	10.2 × 5.3 × 15.2	9.3 × 4.7		
4A0675							
4A0675							
4A0675	FS5972-800-99	800	69.4	11.8 × 6.3 × 28.2	10.8 × 8.3		
4A0675							
4A0675							

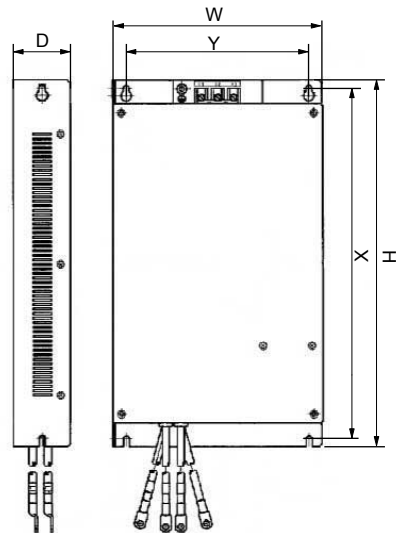

Figure 1

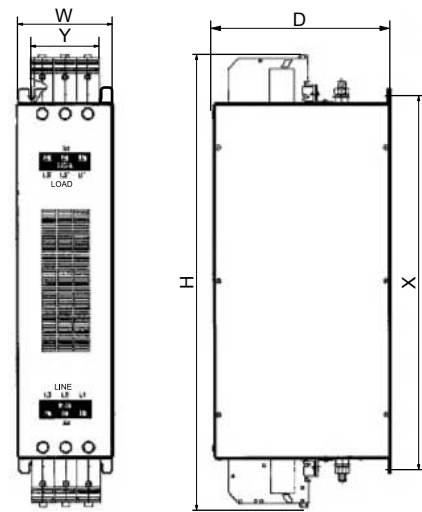

Figure 2

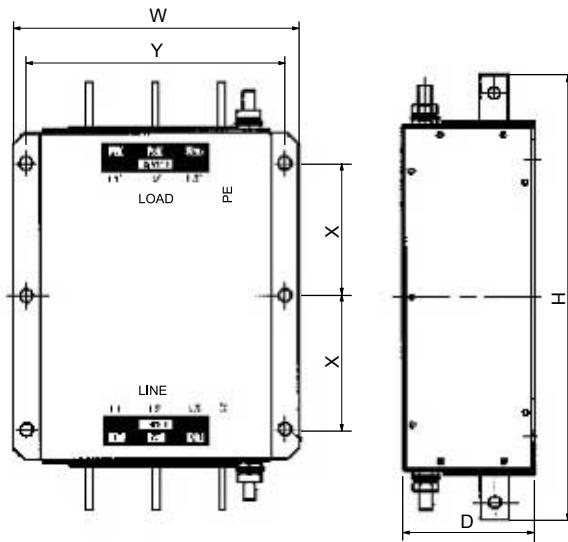

Figure 3

Figure C.5 EMC Filter Dimensions

■ DC Link Chokes for EN 61000-3-2 Compliance

Table C.3 DC Link Chokes for Harmonic Reduction

Drive Model	DC Link Chokes	
	Model	Rating
200 V Three-Phase Units		
2A0004	UZDA-B	5.4 A 8 mH
2A0006		
400 V Three-Phase Units		
4A0002	UZDA-B	3.2 A 28 mH
4A0004		

Note: DC link chokes are not required for other models to comply with EMC.

C.2 UL and CSA Standards

◆ UL Standards Compliance

The UL/cUL mark applies to products in the United States and Canada. It indicates that UL has performed product testing and evaluation, and determined that their stringent standards for product safety have been met. For a product to receive UL certification, all components inside that product must also receive UL certification.



Figure C.6 UL/cUL Mark

This drive is tested in accordance with UL standard UL508C and complies with UL requirements. The conditions described below must be met to maintain compliance when using this drive in combination with other equipment:

■ Installation Area

Do not install the drive to an area greater than pollution degree 2 (UL standard).

■ Main Circuit Terminal Wiring

Yaskawa recommends using closed-loop crimp terminals on all drive models. To maintain UL/cUL approval, UL-Listed closed-loop crimp terminals are specifically required when wiring the drive main circuit terminals on models 2A0110 to 2A0415, 4A0058 to 4A0675, and 5A0041 to 5A0242. Use only the tools recommended by the terminal manufacturer for crimping. [Refer to Closed-Loop Crimp Terminal Size on page 239](#) for closed-loop crimp terminal recommendations.

Closed-Loop Crimp Terminal Recommendations

Yaskawa recommends crimp terminals made by JST and Tokyo DIP (or equivalent) for the insulation cap. [Table C.4](#) matches the wire gauges and terminal screw sizes with Yaskawa-recommended crimp terminals, tools, and insulation caps. Refer to the appropriate Wire Gauge and Torque Specifications table for the wire gauge and screw size for your drive model. Place orders with a Yaskawa representative or the Yaskawa sales department.

The closed-loop crimp terminal sizes and values listed in [Table C.4](#) are Yaskawa recommendations.

Wire gauge values shown in ***bold italic*** are the recommended values. Refer to local codes for proper selections.

Table C.4 Closed-Loop Crimp Terminal Size

Drive Model	Wire Gauge (AWG, kcmil)		Screw Size	Crimp Terminal Model Number	Tool		Insulation Cap Model No.	Code <1>
	R/L1, S/L2, T/L3	U/T1, V/T2, W/T3			Machine No.	Die Jaw		
200 V Class								
2A0004 2A0006 2A0008 2A0010	<i>14</i>		M4	R2-4	YA-4	AD-900	TP-003	100-054-028
	12			R5.5-4			TP-005	100-054-029
	10							
2A0012	14	<i>14</i>	M4	R2-4	YA-4	AD-900	TP-003	100-054-028
	<i>12</i>	12		R5.5-4			TP-005	100-054-029
	10							
2A0018	–	14	M4	R2-4	YA-4	AD-900	TP-003	100-054-028
	12			R5.5-4			TP-005	100-054-029
	<i>10</i>							
2A0021	12		M4	R5.5-4	YA-4	AD-900	TP-005	100-054-029
	<i>10</i>							
2A0030	10		M4	R5.5-4	YA-4	AD-900	TP-005	100-054-029
	<i>8</i>			8-4		AD-901	TP-008	100-054-031
	6			14-NK4		AD-902	TP-014	100-054-033

C.2 UL and CSA Standards

Drive Model	Wire Gauge (AWG, kcmil)		Screw Size	Crimp Terminal Model Number	Tool		Insulation Cap Model No.	Code <?>
	R/L1, S/L2, T/L3	U/T1, V/T2, W/T3			Machine No.	Die Jaw		
2A0040	8	8	M4	8-4	YA-4	AD-901	TP-008	100-054-031
	6	6		14-NK4		AD-902	TP-014	100-054-033
2A0056	6	4	M6	R14-6	YA-5	AD-952	TP-014	100-051-261
	4			R22-6		AD-953	TP-022	100-051-262
2A0069	4	3	M8	R22-8	YA-5	AD-953	TP-022	100-051-263
	3			R38-8		AD-954	TP-038	100-051-264
2A0081	3	2	M8	R38-8	YA-5	AD-954	TP-038	100-051-264
	2							
2A0110	3	1/0	M8	R38-8	YA-5	AD-954	TP-038	100-051-264
	2							
	1							
	1/0							
2A0138	1	1/0	M10	R38-10	YF-1 YET-300-1	TD-321, TD-311	TP-060	100-061-114
	1/0			R60-10				100-051-266
	2/0			70-10		TD-323, TD-312	TP-080	100-054-036
2A0169	2/0	–	M10	70-10	YF-1 YET-300-1	TD-323, TD-312	TP-080	100-054-036
	3/0	–		80-10				100-051-267
	4/0	–		R100-10		TD-324, TD-312	TP-100	100-051-269
2A0211	1/0 × 2P		M10	R60-10	YF-1 YET-300-1	TD-321, TD-311	TP-060	100-051-266
	2/0 × 2P			70-10		TD-323, TD-312	TP-080	100-054-036
2A0250	3/0 × 2P		M12	80-L12	YF-1 YET-300-1	TD-323, TD-312	TP-080	100-051-558
	4/0 × 2P			100-L12		TD-324, TD-312	TP-100	100-051-560
	–	250 × 2P		150-L12		TD-325, TD-313	TP-150	100-051-562
	250	–		R150-12			TP-150	100-051-273
	300							
2A0312	3/0 × 2P	3/0 × 2P	M12	80-L12	YF-1 YET-300-1	TD-323, TD-312	TP-080	100-051-558
	4/0 × 2P	4/0 × 2P		100-L12		TD-324, TD-312	TP-100	100-051-560
	250 × 2P			150-L12		TD-325, TD-313	TP-150	100-051-562
	300 × 2P							
2A0360	4/0 × 2P	4/0 × 2P	M12	100-L12	YF-1 YET-300-1	TD-324, TD-312	TP-100	100-051-560
	250 × 2P	250 × 2P		150-L12		TD-325, TD-313	TP-150	100-051-562
	300 × 2P			180-L12		TD-327, TD-314	TP-200	100-066-688 100-051-564
	350 × 2P			200-L12				
	400 × 2P			325-12		TD-328, TD-315	TP-325	100-051-277
	500 × 2P							
	600	600 × 2P						
2A0415	250 × 2P	–	M12	150-L12	YF-1 YET-300-1	TD-325, TD-313	TP-150	100-051-562
	300 × 2P	300 × 2P		180-L12		TD-327, TD-314	TP-200	100-066-688 100-051-564
	350 × 2P	350 × 2P		200-L12				
	400 × 2P			325-12		TD-328, TD-315	TP-325	100-051-277
	500 × 2P							
	600 × 2P							

Drive Model	Wire Gauge (AWG, kcmil)		Screw Size	Crimp Terminal Model Number	Tool		Insulation Cap Model No.	Code <1>		
	R/L1, S/L2, T/L3	U/T1, V/T2, W/T3			Machine No.	Die Jaw				
400 V Class										
4A0002 4A0004 4A0005 4A0007 4A0009	14		M4	R2-4	YA-4	AD-900	TP-003	100-054-028		
	12			R5.5-4			TP-005	100-054-029		
	10									
4A0011	14	14	M4	R2-4	YA-4	AD-900	TP-003	100-054-028		
	12	12		R5.5-4			TP-005	100-054-029		
	10									
4A0018	12		M4	R5.5-4	YA-4	AD-900	TP-005	100-054-029		
	10			8-4		AD-901	TP-008	100-054-031		
	8			14-NK4		AD-902	TP-014	100-054-033		
	6									
4A0023	10		M4	R5.5-4	YA-4	AD-900	TP-005	100-054-029		
	8			8-4		AD-901	TP-008	100-054-031		
	6			14-NK4		AD-902	TP-014	100-054-033		
4A0031	-		M5	R5.5-5	YA-4	AD-900	TP-005	100-054-030		
	8			R8-5		AD-901	TP-008	100-054-032		
	6			R14-5		AD-902	TP-014	100-054-034		
4A0038	8	8	M5	R8-5	YA-4	AD-901	TP-008	100-054-032		
	6	6		R14-5		AD-902	TP-014	100-054-034		
4A0044	6		M6	R14-6	YA-5	AD-952	TP-014	100-051-261		
	4			R22-6		AD-953	TP-022	100-051-262		
4A0058	6		M8	R14-8	YA-5	AD-952	TP-014	100-054-035		
	4			R22-8		AD-953	TP-022	100-051-263		
4A0072	4		M8	R22-8	YA-5	AD-953	TP-022	100-051-263		
	3			R38-8		AD-954	TP-038	100-051-264		
4A0088	3		M8	R38-8	YA-5	AD-954	TP-038	100-051-264		
	2									
	1									
	1/0								R60-8	AD-955
4A0103	2		M8	R38-8	YA-5	AD-954	TP-038	100-051-264		
	1	1								
	1/0	1/0							R60-8	AD-955
4A0139	1/0		M10	R60-10	YF-1 YET-300-1	TD-321, TD-311	TP-060	100-051-266		
	2/0	2/0		70-10		TD-323, TD-312	TP-080	100-054-036		
	3/0	3/0		80-10		TD-324, TD-312	TP-100	100-051-267		
	4/0			R100-10				100-051-269		
4A0165	3/0		M10	80-10	YF-1 YET-300-1	TD-323, TD-312	TP-080	100-051-267		
	4/0			R100-10		TD-324, TD-312	TP-100	100-051-269		
4A0208	2 × 2P		M10	38-L10	YF-1 YET-150-1	TD-224, TD-212	TP-038	100-051-556		
	1 × 2P					80-L10	TD-227, TD-214	TP-080	100-051-557	
	3/0 × 2P						R100-10	TD-228, TD-214	TP-100	100-051-269
	4/0						R150-10	TD-229, TD-215	TP-150	100-051-272
	250									
300										

C.2 UL and CSA Standards

Drive Model	Wire Gauge (AWG, kcmil)		Screw Size	Crimp Terminal Model Number	Tool		Insulation Cap Model No.	Code <1>
	R/L1, S/L2, T/L3	U/T1, V/T2, W/T3			Machine No.	Die Jaw		
4A0250	1 × 2P	–	M10	38-L10	YF-1 YET-150-1	TD-224, TD-212	TP-038	100-051-556
	3/0 × 2P			80-L10		TD-227, TD-214	TP-080	100-051-557
	4/0 × 2P			100-L10		TD-228, TD-214	TP-100	100-051-559
	250 × 2P			150-L10		TD-229, TD-215	TP-150	100-051-561
	300			R150-10			TP-150	100-051-272
	350			180-10	YF-1 YET-300-1	TD-327, TD-314	TP-200	100-066-687
	400			200-10		TD-328, TD-315		100-051-563
	500			325-10		TD-328, TD-315	TP-325	100-051-565
	600							
4A0296	3/0 × 2P		M12	80-L12	YF-1 YET-300-1	TD-323, TD-312	TP-080	100-051-558
	4/0 × 2P			100-L12		TD-324, TD-312	TP-100	100-051-560
	250 × 2P			150-L12		TD-325, TD-313	TP-150	100-051-562
	300 × 2P							
	–	350 × 2P		180-L12		TD-327, TD-314	TP-200	100-066-688
	350	–		180-12				100-066-689
	400			R200-12				100-051-275
	500			325-12		TD-328, TD-315	TP-325	100-051-277
	600							
4A0362	3/0 × 2P		M12	80-L12	YF-1 YET-300-1	TD-323, TD-312	TP-080	100-051-558
	4/0 × 2P			100-L12		TD-324, TD-312	TP-100	100-051-560
	250 × 2P			150-L12		TD-325, TD-313	TP-150	100-051-562
	300 × 2P							
	350 × 2P			180-L12		TD-327, TD-314	TP-200	100-066-688
	400 × 2P			200-L12				100-051-564
	500			325-12				TD-328, TD-315
	600							
4A0414	4/0 × 2P		M12	100-L12	YF-1 YET-300-1	TD-324, TD-312	TP-100	100-051-560
	250 × 2P			150-L12		TD-325, TD-313	TP-150	100-051-562
	300 × 2P							
4A0515	3/0 × 4P	3/0 × 4P	M12	80-L12	YF-1 YET-300-1	TD-323, TD-312	TP-080	100-051-558
	4/0 × 4P	4/0 × 4P		100-L12		TD-324, TD-312	TP-100	100-051-560
	250 × 4P			150-L12		TD-325, TD-313	TP-150	100-051-562
	300 × 2P							
4A0675	4/0 × 4P		M12	100-L12	YF-1 YET-300-1	TD-324, TD-312	TP-100	100-051-560
	250 × 4P			150-L12		TD-325, TD-313	TP-150	100-051-562
	300 × 4P							

<1> Codes refer to a set of three crimp terminals and three insulation caps. Prepare input and output wiring using two sets for each connection.

Example 1: Models with 300 kcmil for both input and output require one set for input terminals and one set for output terminals, so the user should order two sets of [100-051-272].

Example 2: Models with 4/0 AWG × 2P for both input and output require two sets for input terminals and two sets for output terminals, so the user should order four sets of [100-051-560].

Note: Use crimp insulated terminals or insulated shrink tubing for wiring connections. Wires should have a continuous maximum allowable temperature of 75 °C 600 Vac UL-approved vinyl-sheathed insulation.

Input Fuse Installation

Yaskawa recommends installing one of the following types of branch circuit protection to maintain compliance with UL508C. Semiconductor protective type fuses are preferred. Alternate branch circuit protection devices are also listed in [Table C.5](#).

Table C.5 Factory Recommended AC Drive Branch Circuit Protection (Normal Duty)

Drive Model	Nominal Output Power HP	AC Drive Input Amps	MCCB Rating Amps <1>	Time Delay Fuse Rating Amps <2>	Non-time Delay Fuse Rating Amps <3>	Bussman Semiconductor Fuse Rating (Fuse Ampere) <4>
200 V Class						
2A0004	0.75	3.9	15	6.25	10	FWH-70B (70)
2A0006	1 - 1.5	7.3	15	12	20	FWH-70B (70)
2A0008	2	8.8	15	15	25	FWH-70B (70)
2A0010	3	10.8	20	17.5	30	FWH-70B (70)
2A0012	3	13.9	25	20	40	FWH-70B (70)
2A0018	5	18.5	35	30	50	FWH-90B(90)
2A0021	7.5	24	45	40	70	FWH-90B(90)
2A0030	10	37	60	60	110	FWH-100B (100)
2A0040	15	52	100	90	150	FWH-200B (200)
2A0056	20	68	125	110	200	FWH-200B (200)
2A0069	25	80	150	125	225	FWH-200B (200)
2A0081	30	96	175	150	275	FWH-300A (300)
2A0110	40	111	200	175	300	FWH-300A (300)
2A0138	50	136	250	225	400	FWH-350A (350)
2A0169	60	164	300	250	450	FWH-400A (400)
2A0211	75	200	400	350	600	FWH-400A (400)
2A0250	100	271	500	450	800	FWH-600A (600)
2A0312	125	324	600	500	800	FWH-700A (700)
2A0360	150	394	700	600	1000 <5>	FWH-800A (800)
2A0415	175	471	900	800	1400 <5>	FWH-1000A (1000)
400 V Class						
4A0002	1	2.1	15	3.5	6	FWH-40B (40)
4A0004	2	4.3	15	7.5	12	FWH-50B (50)
4A0005	3	5.9	15	10	17.5	FWH-70B (70)
4A0007	3	8.1	15	12	20	FWH-70B (70)
4A0009	5	9.4	15	15	25	FWH-90B (90)
4A0011	7.5	14	25	20	40	FWH-90B (90)
4A0018	10	20	40	35	60	FWH-80B (80)
4A0023	15	24	45	40	70	FWH-100B (100)
4A0031	20	38	75	60	110	FWH-125B (125)
4A0038	25	44	75	75	125	FWH-200B (200)
4A0044	30	52	100	90	150	FWH-250A (250)
4A0058	40	58	100	100	150	FWH-250A (250)
4A0072	50	71	125	110	200	FWH-250A (250)
4A0088	60	86	150	150	250	FWH-250A (250)
4A0103	75	105	200	175	300	FWH-250A (250)
4A0139	100	142	250	225	400	FWH-350A (350)
4A0165	125	170	300	250	500	FWH-400A (400)
4A0208	150	207	400	350	600	FWH-500A (500)
4A0250	200	248	450	400	700	FWH-600A (600)
4A0296	250	300	600	500	800	FWH-700A (700)
4A0362	300	346	600	600	1000 <5>	FWH-800A (800)

C.2 UL and CSA Standards

Drive Model	Nominal Output Power HP	AC Drive Input Amps	MCCB Rating Amps <1>	Time Delay Fuse Rating Amps <2>	Non-time Delay Fuse Rating Amps <3>	Bussman Semiconductor Fuse Rating (Fuse Ampere) <4>
4A0414	350	410	800	700	1200 <5>	FWH-800A (800)
4A0515	400 - 450	465	900	800	1350 <5>	FWH-1000A (1000)
4A0675	500 - 600	657	1200	1100 <5>	1800 <5>	FWH-1200A (1200)
600 V Class						
5A0003	2	3.6	15	6.25	10	FWP-50B (50)
5A0004	3	5.1	15	8	15	FWP-50B (50)
5A0006	5	8.3	15	12	20	FWP-60B (60)
5A0009	7.5	12	20	20	35	FWP-60B (60)
5A0011	10	16	30	25	45	FWP-70B (70)
5A0017	15	23	40	40	60	FWP-100B (100)
5A0022	20	31	60	50	90	FWP-100B (100)
5A0027	25	38	75	60	110	FWP-125A (125)
5A0032	30	45	75	75	125	FWP-125A (125)
5A0041	40	44	75	75	125	FWP-175A (175)
5A0052	50	54	100	90	150	FWP-175A (175)
5A0062	60	66	125	110	175	FWP-250A (250)
5A0077	75	80	150	125	225	FWP-250A (250)
5A0099	100	108	175	175	300	FWP-250A (250)
5A0125	125	129	225	225	350	FWP-350A (350)
5A0145	150	158	300	275	450	FWP-350A (350)
5A0192	200	228	400	350	600	FWP-600A (600)
5A0242	250	263	500	450	700	FWP-600A (600)

- <1> Maximum MCCB Rating is 15 A, or 200 % of drive input current rating, whichever is larger. MCCB voltage rating must be 600 VAC or greater.
- <2> Maximum Time Delay fuse is 175% of drive input current rating. This covers any Class CC, J or T class fuse.
- <3> Maximum Non-time Delay fuse is 300% of drive input current rating. This covers any CC, J or T class fuse.
- <4> When using semiconductor fuses, Bussman FWH and FWP are required for UL compliance. Select FWH for 200 V Class and 400 V Class models and FWP fuses for 600 V models.
- <5> Class L fuse is also approved for this rating.

■ **Low Voltage Wiring for Control Circuit Terminals**

Wire low voltage wires with NEC Class 1 circuit conductors. Refer to national state or local codes for wiring. The external power supply shall be a UL listed Class 2 power supply source or equivalent only.

Table C.6 Control Circuit Terminal Power Supply

Input / Output	Terminal Signal	Power Supply Specifications
Digital inputs	S1 to S8, SC	Use the internal LVLC power supply of the drive. Use class 2 for external power supply.
Analog inputs / outputs	+V, A1, A2, A3, AC, AM, FM	Use the internal LVLC power supply of the drive. Use class 2 for external power supply.

■ **Drive Short Circuit Rating**

The drive is suitable for use on a circuit capable of delivering not more than 100,000 RMS symmetrical Amperes, 240 Vac maximum (200 V Class), 480 Vac maximum (400 V Class), and 600 Vac maximum (600 V Class) when protected by Busmann Type FWH or FWP fuses as specified in *Factory Recommended Branch Circuit Protection* on page 232.

◆ **CSA Standards Compliance**



Figure C.7 CSA Mark

■ **CSA for Industrial Control Equipment**

The drive is CSA-certified as Industrial Control Equipment Class 3211.

Specifically, the drive is certified to: CAN/CSA C22.2 No. 04-04 and CAN/CSA C22.2 No.14-05.

◆ **Drive Motor Overload Protection**

Set parameter E2-01 (motor rated current) to the appropriate value to enable motor overload protection. The internal motor overload protection is UL listed and in accordance with the NEC and CEC.

■ **E2-01: Motor Rated Current**

Setting Range: Model-dependent

Default Setting: Model-dependent

Parameter E2-01 protects the motor when parameter L1-01 is not set to 0. The default for L1-01 is 1, which enables protection for standard induction motors.

If Auto-Tuning has been performed successfully, the motor data entered to T1-04 is automatically written to parameter E2-01. If Auto-Tuning has not been performed, manually enter the correct motor rated current to parameter E2-01.

■ L1-01: Motor Overload Protection Selection

The drive has an electronic overload protection function (oL1) based on time, output current, and output frequency that protects the motor from overheating. The electronic thermal overload function is UL-recognized, so it does not require an external thermal relay for single motor operation.

This parameter selects the motor overload curve used according to the type of motor applied.

Table C.7 Overload Protection Settings

Setting	Description	
0	Disabled	Disabled the internal motor overload protection of the drive.
1	Standard fan-cooled motor (default)	Selects protection characteristics for a standard self-cooled motor with limited cooling capabilities when running below the rated speed. The motor overload detection level (oL1) is automatically reduced when running below the motor rated speed.
2	Drive duty motor with a speed range of 1:10	Selects protection characteristics for a motor with self-cooling capability within a speed range of 10:1. The motor overload detection level (oL1) is automatically reduced when running below 1/10 of the motor rated speed.
3	Vector motor with a speed range of 1:100	Selects protection characteristics for a motor capable of cooling itself at any speed including zero speed (externally cooled motor). The motor overload detection level (oL1) is constant over the entire speed range.
6	Standard fan-cooled motor (50 Hz)	Selects protection characteristics for a standard self-cooled motor with limited cooling capabilities when running below the rated speed. The motor overload detection level (oL1) is automatically reduced when running below the motor rated speed.

When connecting the drive to more than one motor for simultaneous operation, disable the electronic overload protection (L1-01 = 0) and wire each motor with its own motor thermal overload relay.

Enable motor overload protection (L1-01 ≠ 0) when connecting the drive to a single motor, unless another motor overload preventing device is installed. The drive electronic thermal overload function causes an oL1 fault, which shuts off the output of the drive and prevents additional overheating of the motor. The motor temperature is continually calculated while the drive is powered up.

■ L1-02: Motor Overload Protection Time

Setting Range: 0.1 to 5.0 min

Factory Default: 1.0 min

Parameter L1-02 determines how long the motor is allowed to operate before the oL1 fault occurs when the drive is running at 60 Hz and at 150% of the full load amp rating (E2-01) of the motor. Adjusting the value of L1-02 can shift the set of oL1 curves up the y axis of the diagram below, but will not change the shape of the curves.

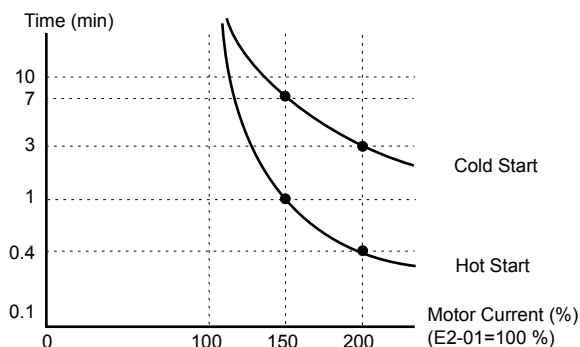

Figure C.8 Motor Overload Protection Time

◆ Precautionary Notes on External Heatsink (IP00/Open Type Enclosure)

When using an external heatsink, UL compliance requires covering exposed capacitors in the main circuit to prevent injury to surrounding personnel.

The portion of the external heatsink that projects out can be protected with the enclosure or with the appropriate capacitor cover after completing drive installation. Use [Table C.8](#) to match drive models with available capacitor covers. Order capacitor covers from a Yaskawa representative or directly from the Yaskawa sales department.

Refer to [Figure C.9](#) for a detailed description of the capacitor cover parts.

Table C.8 Capacitor Cover

Drive Model	Code Number	Model
2A0110	100-061-273	ECAT31875-11
2A0138	100-061-274	ECAT31876-11
2A0169	100-061-275	ECAT31877-11
2A0211		
2A0250	100-061-277	ECAT31726-11
2A0312		
2A0360	100-061-278	ECAT31698-11
2A0415		
4A0058	100-061-273	ECAT31875-11
4A0072	100-061-274	ECAT31876-11
4A0088	100-061-276	ECAT31878-11
4A0103		
4A0139	100-061-275	ECAT31877-11
4A0165		
4A0208	100-061-277	ECAT31726-11
4A0250	100-061-278	ECAT31698-11
4A0296		
4A0362		
4A0414	100-061-279	ECAT31740-11
4A0515	100-061-280	ECAT31746-11
4A0675		
5A0041	100-061-274	ECAT31876-11
5A0052		
5A0062	100-061-275	ECAT31877-11
5A0077		
5A0099		
5A0125	100-061-277	ECAT31726-11
5A0145		
5A0192	100-061-278	ECAT31698-11
5A0242		

<1> Requires two sets.

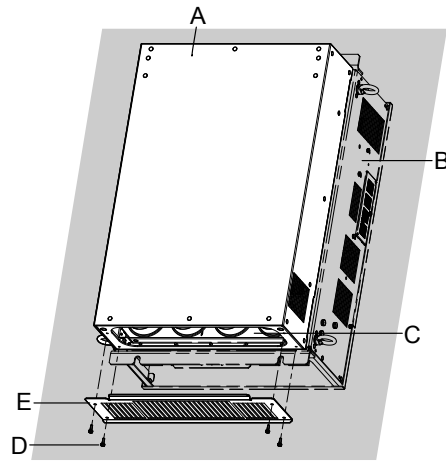

A – Drive (outside panel)
B – Drive (inside panel)
C – Opening to capacitors

D – Installation screws
E – Capacitor cover

Figure C.9 Capacitor Cover

Revision History

The revision dates and the numbers of the revised manuals appear on the bottom of the back cover.

Date of Publication	Revision Number	Section	Revised Content
August 2012	1	Appendix B	Revision: Parameter descriptions corrected.
May 2012	–	–	First Edition. This manual supports drive software version PRG: 8500.

YASKAWA AC Drive P1000

Industrial Fan and Pump Drive

Quick Start Guide

YASKAWA AMERICA, INC.

2121 Norman Drive South, Waukegan, IL 60085, U.S.A.
Phone: (800) YASKAWA (927-5292) or 1-847-887-7000 Fax: 1-847-887-7310
<http://www.yaskawa.com>

DRIVE CENTER (INVERTER PLANT)

2-13-1, Nishimiyaichi, Yukuhashi, Fukuoka, 824-8511, Japan
Phone: 81-930-25-3844 Fax: 81-930-25-4369
<http://www.yaskawa.co.jp>

YASKAWA ELECTRIC CORPORATION

New Pier Takeshiba South Tower, 1-16-1, Kaigan, Minatoku, Tokyo, 105-6891, Japan
Phone: 81-3-5402-4502 Fax: 81-3-5402-4580
<http://www.yaskawa.co.jp>

YASKAWA ELÉTRICO DO BRASIL LTDA.

Avenda Fagundes Filho, 620 Bairro Saude, São Paulo, SP04304-000, Brasil
Phone: 55-11-3585-1100 Fax: 55-11-5581-8795
<http://www.yaskawa.com.br>

YASKAWA EUROPE GmbH

Hauptstrasse 185, 65760 Eschborn, Germany
Phone: 49-6196-569-300 Fax: 49-6196-569-398
<http://www.yaskawa.eu.com>

YASKAWA ELECTRIC UK LTD.

1 Hunt Hill Orchardton Woods, Cumbernauld, G68 9LF, United Kingdom
Phone: 44-1236-735000 Fax: 44-1236-458182
<http://www.yaskawa.co.uk>

YASKAWA ELECTRIC KOREA CORPORATION

9F, Kyobo Securities Bldg., 26-4, Yeouido-dong, Yeongdeungpo-gu, Seoul, 150-737, Korea
Phone: 82-2-784-7844 Fax: 82-2-784-8495
<http://www.yaskawa.co.kr>

YASKAWA ELECTRIC (SINGAPORE) PTE. LTD.

151 Lorong Chuan, #04-01, New Tech Park, 556741, Singapore
Phone: 65-6282-3003 Fax: 65-6289-3003
<http://www.yaskawa.com.sg>

YASKAWA ELECTRIC (SHANGHAI) CO., LTD.

12F, Carlton Bld., No.21 HuangHe Road, HuangPu District, Shanghai 200003, China
Phone: 86-21-5385-2200 Fax: 86-21-5385-3299
<http://www.yaskawa.com.cn>

YASKAWA ELECTRIC (SHANGHAI) CO., LTD. BEIJING OFFICE

Room 1011, Tower W3 Oriental Plaza, No. 1 East Chang An Ave.,
Dong Cheng District, Beijing, 100738, China
Phone: 86-10-8518-4086 Fax: 86-10-8518-4082

YASKAWA ELECTRIC TAIWAN CORPORATION

9F, 16, Nanking E. Rd., Sec. 3, Taipei, 104, Taiwan
Phone: 886-2-2502-5003 Fax: 886-2-2505-1280

YASKAWA ELECTRIC INDIA PRIVATE LIMITED

#17/A Electronics City, Hosur Road Bangalore 560 100 (Karnataka), India
Phone: 91-80-4244-1900 Fax: 91-80-4244-1901
<http://www.yaskawaindia.in>



YASKAWA AMERICA, INC.

In the event that the end user of this product is to be the military and said product is to be employed in any weapons systems or the manufacture thereof, the export will fall under the relevant regulations as stipulated in the Foreign Exchange and Foreign Trade Regulations. Therefore, be sure to follow all procedures and submit all relevant documentation according to any and all rules, regulations and laws that may apply.

Specifications are subject to change without notice for ongoing product modifications and improvements.

© 2012 YASKAWA AMERICA, INC. All rights reserved.



MANUAL NO. TOEP YAIP1U 01A <1>

Published in U.S.A August 2012 12-8